

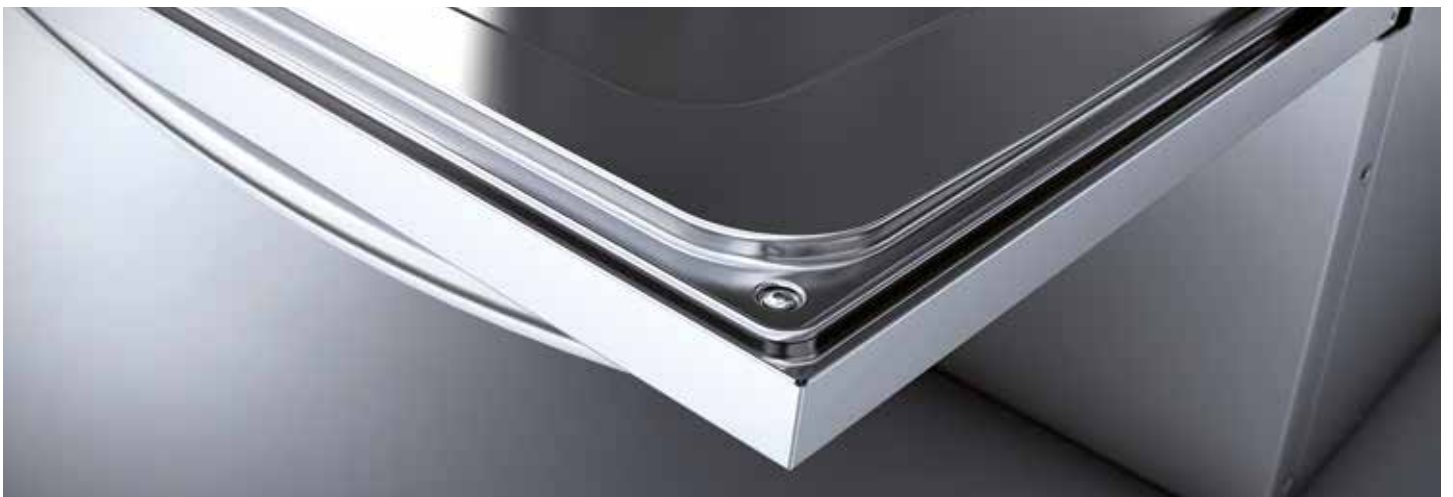

DISHWASHING | E-VO
GENERATION



INNOVATIVE IDEAS,
INVEST IN THE FUTURE.





INDEX

INNOVATIVE IDEAS.
INVEST IN THE FUTURE
04

ONE BODY,
THREE RANGES
07

FEATURES PER RANGE
AND TECHNICAL DATA
08

E-VO ADVANCE. A NEW WAY OF
UNDERSTANDING EXCLUSIVITY
11

E-VO CONCEPT +
MAKE IT SIMPLE. MAKE IT POSSIBLE
15

E-VO CONCEPT. HIGH TECHNOLOGY
AFFORDABLE FOR EVERYONE
19

ACCESSORIES
24



ADVANCE

CONCEPT+

CONCEPT

INNOVATIVE IDEAS,
INVEST IN THE FUTURE.

E-VO GENERATION OFFERS ALL THE BENEFITS AND FEATURES OF THE HIGHEST RANGES, BUT FOR ALL MARKET SEGMENTS, FROM THE LOWEST TO THE HIGHEST.

The E-VO Generation meets all market requirements, beginning with a **single base body and selecting the appropriate technology** to fulfill the needs and requirements of each segment.

The **simplification of the structural parts** and our commitment to **stamped parts** offers many advantages and exceptional performance: very **easy to clean**, maximum **reliability** for intensive use and optimum user **safety**.

E-VO Generation comes in three different ranges:
E-VO Concept, E-VO Concept+ and E-VO Advance.



ONE BODY, THREE RANGES

E-VO Generation is a dream come true, something more than one step further: it is a different and innovative generation... Revolutionary.

Because E-VO is built on a unique basic idea: create a single body structure that offers common benefits for its three different ranges: E-VO ADVANCE, E-VO CONCEPT PLUS and E-VO CONCEPT.

Three ranges which cover not only the specific needs of each client (restaurants, bars, cafes, pubs, schools, hotels, etc.), but create a smarter product and, at the same time, more simple; revolutionizing the commercial dishwashing world.



HOOD-TYPE

- 440 mm hood opening allows the introduction of large containers.
- Counterbalanced handle for easy handling.
- Double upper and lower washing and rinsing system.
- Single stamped and reduced volume washing tank.
- Optional heat recovery element which collects and condenses the vapours produced during washing and rinsing, to improve the energy efficiency.



FRONT LOADING

- 380 mm useful interior clearance, allowing the introduction of GN-1/1 trays.
- Counterbalanced door with stainless steel hinges and double spring.
- Single stamped tank with rounded edges. No sharp elements.
- Reduced volume tank allowing significant water and energy savings.



GLASSWASHER

- Two models with useful interior clearance of 270 mm and 220 mm.
- Double upper and lower washing and rinsing system.

	HOOD-TYPE			FRONT LOADING			GLASSWASHER	
	ADVANCE	CONCEPT+	CONCEPT	ADVANCE	CONCEPT+	CONCEPT	CONCEPT	
BASKET SIZE	500x500	500x500	500x500	500x500	500x500	500x500	400x400	400x400

CONTROL PANEL	OTHERS							
		AD-125		AD-505				
	With rinsing pump		COP-144		COP-504			
	Without rinsing pump			CO-142		CO-502	CO-402	
	Multi - power			CO-110		CO-501		
	Single phase					CO-500	CO-400	CO-350

ADVANCE
CONCEPT PLUS
CONCEPT

ADVANCE
CONCEPT PLUS
CONCEPT

CONCEPT

FEATURES PER RANGE

MACHINE TYPE	HOOD-TYPE			FRONT LOADING			GLASS-WASHERS
	ADVANCE	CONCEPT+	CONCEPT	ADVANCE	CONCEPT+	CONCEPT	CONCEPT
EFFI WASH EFFI-WASH Newly optimized hydraulic system provides a strong mechanical action combined with the optimum clean water in the tank, and the balanced power to keep the perfect hygienic temperature during the whole lifetime of the machine.	•	•	•	•	•	•	•
EFFI RINSE EFFI-RINSE system assures a perfect hygienic result with a linear 85°C full rinsing cycle thanks to its incorporated rinsing pump and air break system design.	•	•	-	•	•	-	-
EFFI SILENT Full Double skin body to isolate machine's noise from the environment, making the atmosphere more peaceful.	•	-	-	•	•	•	-
HRS HRS Fagor's HRS collects and condenses the steam exhausted by the machine after a full cleaning cycle, and heats up the input water from 10°C to 25°C (for example). It also allows to avoid installing a hood in most of the cases.	○	○	○	-	-	-	-
MULTI POWER MULTIPOWER Several machines in one. Perfect solution to minimize your stock. By making an easy change in the electrical connecting box during the installation, you will be able to have a 3,4 kW machine or 6,2 kW or other powers.	•	•	•	•	•	•	- Except CO-500
SELF DRAIN SELF-DRAIN Every washing cycle, SELF-DRAIN takes care of removing dirty water from the tank just before starting to fall the rinsing clean and hot water over the ware.	•	-	-	•	-	-	-
SCI FILTER SCI FILTER Consists in a simple 3 steps filtering system for big, medium and small size dirtiness particles; allowing to keep the wash tank water clean for a longer period of time.	•	-	-	•	-	-	-
SOFT START SOFT-START It assures a low noise level of the bar or restaurant where it is installed and prevents the glasses and ware from moving inside the basket, protecting them from breaking and improving the washing cycle of all the ware.	-	-	-	•	•	•	-
FAGOR SERVICE FAGOR SERVICE Access to internal menu through password to display and check the status of all components: pumps, switches, heating elements, temperature and pressure sensors, etc.	•	-	-	•	-	-	-
SCIENCE SCIENCE ONE TOUCH AT A GLANCE elevates its simplicity and smartness to one single Multi-chromatic button, making operator's life easier and optimizing the operating costs thanks to its intuitive 3 colors code.	•	-	-	•	-	-	-
ECO FILL ECO FILL The NEW Thermostatic tank water filling system: allows to speed up drastically the start-up time of the machine, because the wash tank is filled in with hot water previously heat in the boiler.	•	•	-	•	•	-	-
GN-1/1 GN-1/1 Using our special basket CB7-GN, E-VO Concept, Concept+ and Advance undercounters and hood-type machines are able to wash perfectly GN 1/1 trays. A huge advantage for our customers, thanks to its 380 mm clearance for undercounters and 440 mm for hood-types. A real proof of versatility.	•	•	•	•	•	•	-
ROCK COUNTERBALANCED DOOR ROCK COUNTERBALANCED DOOR Double spring and stainless steel hinge system tested to resist the strongest usage of the market, with more than 360.000 openings.	-	-	-	•	•	•	-
KITS PHILOSOPHY KITS PHILOSOPHY Reduce stock and simplify your order by just selecting the basic versions and adding the kits when required: detergent dispenser and drain pump.No need to have many versions in your stock. Easy to install kits with easy accessibility to the components minimizing the installation risks.	•	•	•	•	•	•	•
STAMPED PHILOSOPHY STAMPED PHILOSOPHY A fully new stainless steel body and structure made to resist and resist to the strongest usage of the market.	•	•	•	•	•	•	-
IPx5 ZERO HUMIDITY IPx5 ZERO-HUMIDITY Designed to have a full protection IPx5 against water hose cleaning and external humidity.	•	-	-	•	-	-	-
SELF-CLEANING SELF-CLEANING It allows the user to avoid hand-cleaning, because the machine will make it for you with this function. It will wash the chamber with detergent, rinse it all and drain everything away, leaving the machine without water in the tank and boiler. This will prevent bad smell and increase your machine's lifetime.	•	-	-	•	-	-	-
MULTI VOLTAGE MULTIVOLTAGE (1+N/3+N)	•	•	•	•	•	•	- Except CO-500
THERMO STOP THERMOSTOP (83 °C)	•	•	• Factory disabled	•	•	• Factory disabled	• Only CO-402

• Standard ○ Option - Not version

SUMMARY OF TECHNICAL DATA

MACHINE TYPE	HOOD-TYPE			FRONT LOADING			GLASSWASHERS						
	ADVANCE	CONCEPT+	CONCEPT	ADVANCE	CONCEPT+	CONCEPT	CONCEPT						
MODEL	AD-125	AD-125 ECO	COP-144	CO-142	CO-110	AD-505	COP-504	CO-502	CO-501	CO-500	CO-400	CO-402	CO-350
Wash Cycles (seconds)	55-75-120 GLASS (**)	55-75-120 GLASS (**)	55-75-120	55-75-120	90-120-180	60-90-120 GLASS (**)	90-120-180	90-120-180	90-120-180	120-180	120	90-120-180	120
Programmable Wash Cycle	•	•	-	-	-	•	-	-	-	-	-	-	-
Continuous Cycle	•	•	•	•	•	-	-	-	-	-	-	-	-
Electronic display	•	•	•	•	-	•	•	•	-	-	-	•	-
Max Productivity (†)													
Baskets/hour	65	65	65	65	40	60	40	40	40	30	30	40	30
Dishes/hour	1170	1170	1170	1170	720	1080	720	720	720	540	-	-	-
Glasses/hour	2340	2340	2340	2340	1440	2160	1440	1440	1440	1080	-	-	-
Trays/hour	455	455	455	455	280	420	280	280	280	210	-	-	-
Standard Basket size (mm)	500 x 500	500 x 500	500 x 500	500 x 500	500 x 500	500 x 500	500 x 500	500 x 500	500 x 500	500 x 500	400 x 400	400 x 400	350 x 350
Able for GN-1/1 trays	•	•	•	•	•	•	•	•	•	•	-	-	-
Dimensions (mm)													
Width	630	630	630	630	630	600	600	600	600	600	470	470	430
Depth	750	750	750	750	750	600	600	600	600	600	520	520	480
Height	1465	1465	1465	1465	1465	830	830	830	830	830	720	720	660
Useful Loading Height (clearance)	440	440	440	440	440	360	360	360	360	360	270	270	220
Open Hood Height	1940	1940	1940	1940	1940	-	-	-	-	-	-	-	-
Capacity (liters)													
Wash Tank	28	28	33	33	33	14	20	20	20	20	15	15	11
Boiler	10	-	10	9	9	7	7	7	7	7	4	4	4
Water consumption per cycle	2,4	2,4	2,4	2,4	2,4	2,4	2,4	2,4	2,4	2,4	2,2	2,2	2,2
Power (kW)													
Tank heating element	2,1	2,1	4,5	4,5	4,5	1,0	2,8	2,8 (**)	2,8 (**)	2,8	2,0	2,0	2,0
Boiler/Booster heating element	9	GWB-20	9	9	6	5,6	5,6	5,6	5,6	2,8	2,8	2,8	2,4
Wash pump(s)	0,6	0,6	0,6	0,6	0,6	0,6	0,6	0,6	0,6	0,6	0,26	0,26	0,26
Rinse pump	0,13	0,13	0,13	-	-	0,13	0,13	-	-	-	-	-	-
Max. power	11,7	2,7	14,1	14,1	11,1	7,2	6,2	6,2	6,2	3,40	3,06	3,06	2,66
Working Temperature (°C)													
Washing	60	60	60	60	60	60	60	60	60	60	60	60	60
Rinsing	85	85	85	85	85	85	85	85	85	85	85	85	85
Multipower	•	•	•	•	•	•	•	•	•	-	-	-	-
Single Phase (1-phase)	•	•	•	•	•	•	•	•	•	•	•	•	•
Three Phases (3-phase)	•	•	•	•	•	•	•	•	•	-	-	-	-
Multivoltage (230 V-1N / 400 V-3 / 400 V-3N)	•	•	•	•	•	•	•	•	•	-	-	-	-
Marine (440 V 3 - 60 Hz.)	-	-	○	○	○	-	○	○	○	○	-	-	-
60Hz Version	○	○	○	○	○	○	○	○	○	○	•	•	•
Water Protection Rating	IPX5	IPX5	IPX4	IPX4	IPX4	IPX5	IPX4	IPX4	IPX4	IPX4	IPX4	IPX4	IPX4
Noise level (dBA)	<63	<63	<65	<65	<65	<63	<65	<65	<65	<65	<70	<70	<70
Rinsing Aid Dispenser	•	•	•	•	•	•	•	•	•	•	•	•	•
Detergent Aid Dispenser	•	•	○	○	○	•	○	○	○	○	○	○	○
Drain Pump	•	•	○	○	○	•	○	○	○	○	○	○	○
Rinse Pump	•	•	•	-	-	•	•	-	-	-	-	-	-
Integrated Softener	○	○	-	-	-	○	-	-	-	-	○	○	-
Double wall - door / hood	•	•	-	-	-	•	•	•	•	•	•	•	•
Double wall - body	-	-	-	-	-	•	•	•	•	•	-	-	-
Wash & Rinse branc - AISI-304	•	•	•	•	•	•	•	•	•	•	-	-	-
Filter trays AISI-304 in the wash tank	•	•	•	•	•	•	•	•	•	•	-	-	-

• Standard (†) Assumed 18 dishes/basket, 36 glasses/basket and 7 trays/basket.
 ○ Optional (**) There is an especial version for 13A limitation installations, the total power gets reduced to 2,8 kW with a 2,2 kW heating element in the tank.
 - No version (***) Special program for washing glassware, based on the specifications of hygiene and safety standard DIN10511. Cycle of 90 seconds, with temperatures: 60 °C (wash) and 65 °C (rinse).

eVO
ADVANCE

A NEW WAY OF UNDERSTANDING EXCLUSIVITY.

Machines designed for those who want the best of the best, but with simple operation, easy to maintain and highly efficient.

E-VO ADVANCE smart machines meet all the requirements that a professional dreams of: latest technology, energy efficiency, efficacy, robustness, customizable washing programs, features such as self-cleaning or self-drain, and self-diagnostic to minimize maintenance time.

An exclusive machine designed to invest today and get profits tomorrow.



HOOD-TYPE | ADVANCE



01. SCIENCE

One touch at a glance elevates its simplicity and smartness to one single Multi-chromatic button, making operator's life easier and optimizing the operating costs thanks to its intuitive 3 colors code. A completely electronic machine: pressure sensing, temperature sensing, electrical control system, automatic draining, timing, etc. Customisable programmes: the technical service can modify the temperature and time of the wash and rinse of the two programmes to meet the needs of the end user. It includes a special default programme (P4/PG) for glassware in accordance with the DIN10511 standard (with a 90° cycle with a washing temperature of 60°C and a rinse temperature of 65°C).

02. DOUBLE WALL HOOD

Double wall hood to isolate the noise of the machine from the environment, creating a more peaceful atmosphere.

Lower water consumption:
28 l tank
2,4 l/cycle

Lower electricity consumption:
11,7 kW max.



MODEL	VOLTAGE	CHARACTERISTICS (#)	POWER (kW)	DIMENSIONS (mm)
AD-125	MULTIVOLTAGE	A - B - DD	MULTIPOWER	630 x 750 x 1.465
AD-125 SOFT	MULTIVOLTAGE	A - B - DD - SOFT	MULTIPOWER	630 x 750 x 1.465
AD-125 HRS	MULTIVOLTAGE	HRS - A - B - DD	MULTIPOWER	630 x 750 x 1.920
AD-125 SOFT HRS	MULTIVOLTAGE	A - B - DD - SOFT - HRS	MULTIPOWER	630 x 750 x 1.920
AD-125 ECO	230 V - 1N	A - B - DD	2,7	630 x 750 x 1.465

GAS WATER BOOSTER GWB-20

MODEL	GAS / FREQUENCY	DESCRIPTION	POWER (kW)	DIMENSIONS (mm)
GWB-20	LPG 50 Hz LPG 60 Hz GN 50 Hz GN 60 Hz	GAS WATER BOOSTER Forced draught burner and double safety valve. Electronic control of temperature and water levels. Automatic limescale removal. Automatic tank emptying.	20	432x548x770

FRONT LOADING | ADVANCE



Lower water consumption:
14 l tank
2,4 l/cycle

Lower electricity consumption:
7,2 kW max.



01. SELF-DRAIN

Every washing cycle, SELF-DRAIN takes care of removing dirty water from the tank just before starting to fall the rinsing clean water over the ware. Therefore, you will be able to keep the wash tank clean during much more time, optimizing your running costs thanks to energy savings.

02. SELF-CLEANING

It allows the user to avoid hand-cleaning, because the machine will make it for you with this function. It will wash the chamber with detergent, rinse it all and drain everything away, leaving the machine without water in the tank and boiler. This will prevent bad smell and increase your machine's lifetime.

03. IPX5 ZERO HUMIDITY

Designed to have a full protection IPX5 against water hose cleaning and external humidity.



MODEL	VOLTAGE	CHARACTERISTICS (#)	POWER (kW)	DIMENSIONS (mm)
AD-505	MULTIVOLTAGE	A - B - DD	MULTIPOWER	600x600x830
AD-505 SOFT	MULTIVOLTAGE	A - B - DD - SOFT	MULTIPOWER	600x632x830

(#) VERSIONS AND CHARACTERISTICS

VERSION	CHARACTERISTICS
SOFT	Built-in descaling unit and timer for regeneration cycle
HRS	Machine with heat recovery system - power 30 W Total high of the machine: 1.900 mm
DD	Built-in detergent doser
B	Built-in drain pump - power 70 W - drainage cycle
A	Built-in rinse booster pump - power 150 W

eVO
CONCEPT +

MAKE IT SIMPLE,
MAKE IT POSSIBLE.

E-VO CONCEPT+ range offers a highly efficient and effective washing and rinsing system (EFFI-WASH & EFFI-RINSE) becoming in the perfect solution for those locations with low pressure water network and though efficacy requirements.

E-VO CONCEPT+ has arrived, simply possible.



HOOD-TYPE | CONCEPT +



01. EFFI-RINSE
The EFFI-RINSE system guarantees a perfect, hygienic result with a complete, linear rinse cycle at 85°C thanks to the built-in rinsing pump and the Air Break system design. It also works with low input water pressure, making it the perfect system when the mains water of the installation does not reach the minimum recommended pressure of 2 bar. The green EFFI-RINSE light shows when the machine rinses at 85°C.

02. KITS PHILOSOPHY
Reduce stock and simplify your order by just selecting the basic versions and adding the kits when required: detergent dispenser and drain pump. No need to have many versions in your stock. Easy to install kits with easy accessibility to the components minimizing the installation risks.

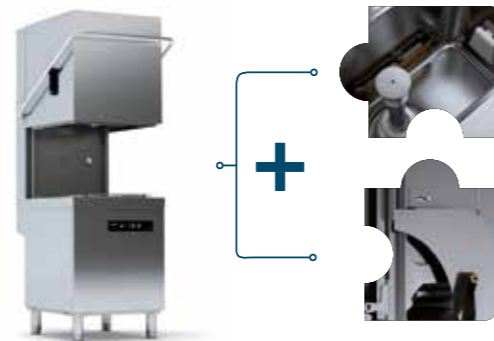

MODEL	VOLTAGE	CHARACTERISTICS (#)	POWER (kW)	DIMENSIONS (mm)
COP-144	MULTIVOLTAGE	A	9,6 / 14,10	630 x 750 x 1.465
COP-144 B	MULTIVOLTAGE	A - B	9,6 / 14,10	630 x 750 x 1.465
COP-144 DD	MULTIVOLTAGE	A - DD	9,6 / 14,10	630 x 750 x 1.465
COP-144 B DD	MULTIVOLTAGE	A - B - DD	9,6 / 14,10	630 x 750 x 1.465
COP-144 HRS	MULTIVOLTAGE	HRS - A - DD	9,63 / 14,13	630 x 750 x 1.920
COP-144 HRS B DD	MULTIVOLTAGE	HRS - A - B - DD	9,63 / 14,13	630 x 750 x 1.920

(#) VERSIONS AND CHARACTERISTICS

VERSION	CHARACTERISTICS
HRS	Machine with heat recovery system - power 30 W Total high of the machine: 1.900 mm
A	Rinse pump - 150 W
DD	Built-in detergent doser
B	Built-in drain pump - power 70 W - drainage cycle

FRONT LOADING | CONCEPT +



01. ECO FILL
The Thermostatic tank water filling system: allows to speed up drastically the start-up time of the machine, because the wash tank is filled in with hot water previously heat in the boiler.



02. STAMPED PHILOSOPHY
A fully new stainless steel body and structure made to resist and resist to the strongest usage of the market. An evolved generation with stamped new door design, stamped wash tank and basket guides... We bet for this philosophy because it reduces your running costs so that you will spend less time cleaning and increase machine's lifetime.



MODEL	VOLTAGE	CHARACTERISTICS (#)	POWER (kW)	DIMENSIONS (mm)
COP-504	MULTIVOLTAGE	A	MULTIPOWER	600x600x830
COP-504 B	MULTIVOLTAGE	A - B	MULTIPOWER	600x600x830
COP-504 DD	MULTIVOLTAGE	A - DD	MULTIPOWER	600x600x830
COP-504 B DD	MULTIVOLTAGE	A - B - DD	MULTIPOWER	600x600x830

(#) VERSIONS AND CHARACTERISTICS

VERSION	CHARACTERISTICS
A	Built-in rinse booster pump - power 150 W
DD	Built-in drain pump - power 30 W - drainage cycle
B	Built-in detergent doser



HIGH TECHNOLOGY AFFORDABLE FOR EVERYONE.

For those who believe that technology and simplicity can go hand in hand,
E-VO CONCEPT has landed.

A winner in its category that combines features and benefits that only high-end
ranges are offering, becoming in a product easy to use and efficient, with the most
effective and robust technology prepared for the strongest usage of the market.



HOOD-TYPE | CONCEPT

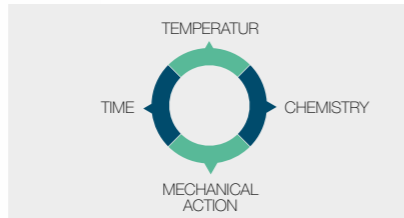

01. EFFI-WASH

This hydraulic system offers intense mechanical action combined with the perfectly clean water in the tank and the balanced power to maintain an optimum hygienic temperature for the entire lifespan of the machine - all whilst guaranteeing the productivity promised. An efficient system that ensures one of the most important factors of the Sinner circle: mechanical action. It also leads to savings in chemical products and reduces washing time.

02. MULTIPOWER

If you want maximum power to increase the productivity of the machine, it is possible to configure it easily. If you would prefer lower consumption, you have to simply make the right connection on the terminal strip. Several versions in the same machine.

03. STAMPED PHILOSOPHY

A body and structure made entirely of stainless steel to withstand the most intensive use. A generation that has evolved with a new hood design, new basket rails and an embedded wash tank. We support this philosophy because it makes it possible to reduce cleaning time and daily maintenance costs and, at the same time, increase the lifespan of the machine.



CO-142 MODELS	VOLTAGE	CHARACTERISTICS (#)	POWER (kW)	DIMENSIONS (mm)
CO-142 B	MULTIVOLTAGE	B	9,6 / 14,10	630 x 750 x 1.465
CO-142 DD	MULTIVOLTAGE	DD	9,6 / 14,10	630 x 750 x 1.465
CO-142 B DD	MULTIVOLTAGE	B - DD	9,6 / 14,10	630 x 750 x 1.465
CO-142 HRS	MULTIVOLTAGE	HRS	9,6 / 14,10	630 x 750 x 1.920
CO-142 HRS B DD	MULTIVOLTAGE	HRS B - DD	9,6 / 14,10	630 x 750 x 1.920
CO-110 MODELS				
CO-110 B	MULTIVOLTAGE	B	6,6 / 11,1	630 x 750 x 1.465
CO-110 DD	MULTIVOLTAGE	DD	6,6 / 11,1	630 x 750 x 1.465
CO-110 B DD	MULTIVOLTAGE	B-DD	6,6 / 11,1	630 x 750 x 1.465
CO-110 HRS	MULTIVOLTAGE	HRS	6,6 / 11,1	630 x 750 x 1.920
CO-110 HRS B DD	MULTIVOLTAGE	HRS B - DD	6,6 / 11,1	630 x 750 x 1.920

(#) VERSIONS AND CHARACTERISTICS

VERSION	CHARACTERISTICS
HRS	Machine with heat recovery system - power 30 W Total high of the machine: 1.900 mm
DD	Built-in detergent doser
B	Built-in drain pump - power 70 W - drainage cycle

FRONT LOADING | CONCEPT



01. GN-1/1

Using our special basket CB7-GN, E-VO CONCEPT, CONCEPT PLUS and ADVANCE undercounters and hood-type machines are able to wash perfectly GN 1/1 trays. A huge advantage for our customers, thanks to its 380 mm clearance for undercounters and 440 mm for hood-types.

02. DOUBLE WALL

E-VO Generation was built based on a unique idea: to create a single body which would contain common benefits for the three ranges. Thanks to this idea, even the most basic range has a body built with a double wall, and both the body and the structure are manufactured entirely in stainless steel.

03. ROCK COUNTERBALANCED DOOR

Double spring and stainless steel hinge system tested to resist the strongest usage of the market, with more than 360.000 openings. It also protects the user from burnings with steam thanks to the 3 compensated steps designed:

- (1) - remove steam.
- (2) - check basket.
- (3) - remove/ place basket.



CO-502 MODELS	VOLTAGE	CHARACTERISTICS (#)	POWER (kW)	DIMENSIONS (mm)
CO-502 B	MULTIVOLTAGE	B	MULTIPOWER	600x600x830
CO-502 DD	MULTIVOLTAGE	DD	MULTIPOWER	600x600x830
CO-502 B DD	MULTIVOLTAGE	B-DD	MULTIPOWER	600x600x830
CO-501 MODELS				
CO-501 B	MULTIVOLTAGE	B	MULTIPOWER	600x600x830
CO-501 DD	MULTIVOLTAGE	DD	MULTIPOWER	600x600x830
CO-501 B DD	MULTIVOLTAGE	B-DD	MULTIPOWER	600x600x830
CO-500 MODELS				
CO-500 B	230 V 1+N	B	3,4	600x600x830
CO-500 DD	230 V 1+N	DD	3,4	600x600x830
CO-500 B DD	230 V 1+N	B - DD	3,4	600x600x830

(#) VERSIONS AND CHARACTERISTICS

VERSION	CHARACTERISTICS
DD	Built-in detergent doser
B	Built-in drain pump - power 30 W - drainage cycle

GLASSWASHER | CONCEPT

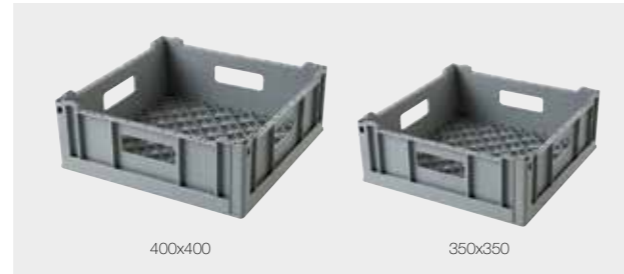
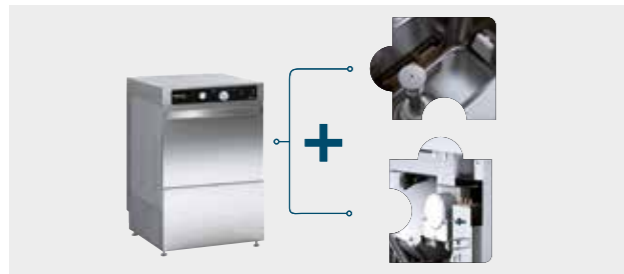

01. KITS PHILOSOPHY

Reduce stock and simplify your order by just selecting the basic versions and adding the kits when required: detergent dispenser and drain pump. No need to have many versions in your stock. Easy to install kits with easy accessibility to the components minimizing the installation risks.

02. VERSATILITY

The glasswasher models available make it possible to use smaller baskets compared to the front-opening dishwashers. With these models, 400x400 and 350x350 sized baskets can be used.



MODEL	Hz.	VOLTAGE	CHARACTERISTICS (#)	POWER (kW)	DIMENSIONS (mm)
CO-402 COLD	50/60	230 V / 1N	COLD	3,06	470x520x720
CO-402 COLD B	50/60	230 V / 1N	COLD - B	3,06	470x520x720
CO-402 COLD DD	50/60	230 V / 1N	COLD - DD	3,06	470x520x720
CO-402 COLD B DD	50/60	230 V / 1N	COLD - B - DD	3,06	470x520x720
CO-402 SOFT DD	50/60	230 V / 1N	SOFT - DD	3,06	470x520x720

(#) VERSIONS AND CHARACTERISTICS

VERSION	CHARACTERISTICS
COLD	Push button for an optional cold rinse at the end of the cycle
B	Built-in drain pump - power 30 W - Drainage cycle
DD	Built-in detergent doser
SOFT	Built-in descaling unit and timer for regeneration cycle



CO-400 MODELS	Hz.	VOLTAGE	CHARACTERISTICS (#)	POWER (kW)	DIMENSIONS (mm)
CO-400 COLD	50/60	230 V / 1N	COLD	3,06	470x520x720
CO-400 COLD B	50/60	230 V / 1N	COLD - B	3,06	470x520x720
CO-400 COLD DD	50/60	230 V / 1N	COLD - DD	3,06	470x520x720
CO-400 COLD B DD	50/60	230 V / 1N	COLD - B - DD	3,06	470x520x720
CO-400 SOFT DD	50/60	230 V / 1N	SOFT - DD	3,06	470x520x720

CO-350 MODELS	Hz.	VOLTAGE	CHARACTERISTICS (#)	POWER (kW)	DIMENSIONS (mm)
CO-350 B	50/60	230 V / 1N	B	2,66	430x480x660
CO-350 DD	50/60	230 V / 1N	DD	2,66	430x480x660
CO-350 B DD	50/60	230 V / 1N	B - DD	2,66	430x480x660
CO-350 COLD	50/60	230 V / 1N	COLD	2,66	430x480x660
CO-350 COLD B	50/60	230 V / 1N	COLD - B	2,66	430x480x660
CO-350 COLD DD	50/60	230 V / 1N	COLD - DD	2,66	430x480x660
CO-350 COLD B DD	50/60	230 V / 1N	COLD - B - DD	2,66	430x480x660





(#) VERSIONS AND CHARACTERISTICS

VERSION	CHARACTERISTICS
COLD	Push button for an optional cold rinse at the end of the cycle
B	Built-in drain pump - power 30 W - Drainage cycle
DD	Built-in detergent doser
SOFT	Built-in descaling unit and timer for regeneration cycle

ACCESSORIES | TABLES FOR HOOD TYPE DISHWASHERS











ENTRY / EXIT TABLES

MODEL	TO PLACE ON THE	EQUIPMENT (*)	DIMENSION (mm)
 MP-620-I	Left	P - E	620x740x880
 MP-620-D	Right	P - E	620x740x880
 MLP-1200-I E-VO	Left	P - E	1.200x740x880
 MLP-1200-D E-VO	Right	P - E	1.200x740x880

(*) **E:** Lower rack / **P:** Removable splashback

PREWASHING TABLES

MODEL	TO PLACE ON THE	EQUIPMENT (*)	DIMENSION (mm)
 MF-700-I E-VO	Left	P - E - F	700x740x880
 MF-700-D E-VO	Right	P - E - F	700x740x880
 MF-1200-I E-VO	Left	P - E - F	1.200x740x880
 MF-1200-D E-VO	Right	P - E - F	1.200x740x880
 MFD-1200-I E-VO	Left	P - E - F - O	1.200x740x880
 MFD-1200-D E-VO	Right	P - E - F - O	1.200x740x880
 MFD-1500-I E-VO	Left	P - E - F - O	1.500x740x880
 MFD-1500-D E-VO	Right	P - E - F - O	1.500x740x880

(*) **E:** Lower rack / **P:** Splashback / **F:** Bowl / **O:** Waste scraping hole.

UNION ELEMENT FOR HOOD DISHWASHERS

MODEL	DESCRIPTION	DIMENSION (mm)
 MP-140	Element for joining two hood dishwasher in series	140x740x350



STAND FOR FRONT LOADING DISHWASHERS AND GLASSWASHER



MODEL	VALID FOR MODELS	DESCRIPTION	DIMENSION (mm)
EVPL-60	FRONT-OPENING DISHWASHER	Capacity for 3 baskets 500x500	600x600x400
EVPL-47	CO-402 / CO-400	Capacity for 2 baskets 400x400	470x450x400
EVPL-43	CO-350	Capacity for 2 baskets 350x350	430x405x400

TRANSFORMATION KITS FOR E-VO DISHWASHERS

KIT TO TRANSFORM THE BASIC VERSIONS (EXCEPT FOR SOFT VERSIONS)

MODEL	VALID FOR	DESCRIPTION	POWER (kW)
DD 	HOOD DISHWASHERS FRONT-OPENING DISHWASHERS GLASSWASHERS	PERISTÁLTIC DETERGENT DOSER	-
B-70 	HOOD DISHWASHERS	KIT DRAIN PUMP - 50/60 Hz.	70
B-30 	FRONT-OPENING DISHWASHERS GLASSWASHERS	KIT DRAIN PUMP - 50/60 Hz.	30

KIT TRAYS-FILTER FOR WASH TANK

MODEL	DESCRIPTION
K-BF-500 	KIT 2 TRAYS-FILTER FOR WASH TANK
MODELO	DESCRIPCIÓN
REPLACEMENT KIT	Kit of elements to adapt the old tables to a 2019 hood dishwasher

FAGOR INDUSTRIAL S. COOP.
Santxolopetegi auzoa, 22
20560 Oñati, Gipuzkoa (Spain)
T. (+34) 943 71 80 30
F. (+34) 943 71 81 81
info@fagorindustrial.com

www.fagorindustrial.com



ISO 9001

