

# Evox 25



Touch panel



Ultra-rapid vacuum



Easy to use

## Excellent technology, compact design

Compact, ergonomic, versatile and equipped with vacuum sensor, Evox 25 represents a result of absolute excellence. Its surprisingly small dimensions, including a height of only 21 cm, make the Evox 25 the perfect vacuum packaging machine for use in any business or kitchen with small spaces.

## Evox 25 is ideal for:



Small restaurant



Bar



Small gastronomy



Butcher shops

## Packing methods



Sealing only



Vacuum



External vacuum



Ultra-resistant vacuum chamber



Containers base



Suction valve



Removable sealing bar without tools

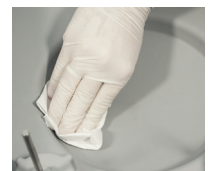





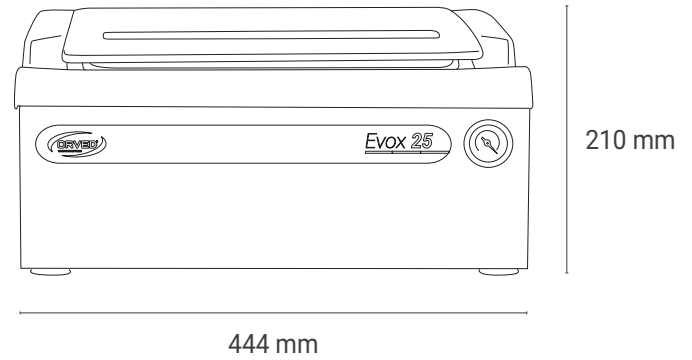

Always perfect chamber cleaning

## Technical data

- > Bodywork: stainless steel
- > Size: 444x481x210h mm
- > Chamber size: 303x293x110h mm
- > Chamber volume: 7,65 lt.
- > Weight: 24 kg
- > Power grid voltage: 220-240V 50/60Hz
- > Max power absorption: 297 W
- > Sealing bars: 260 mm
- > Vacuum pump: 4 mc/h
- > Final pressure: 2-4 mbar
- > Max bag size: 250x300 mm



## Standard equipment

-  Touch panel
-  Easy accessory included
-  Suction tube included
-  Vacuum sensor
-  H2out pump dehumidification program
-  Device to operate vacuum in container

## Matching accessories



Smooth vacuum bags



Channelled vacuum bags



Cooking vacuum bags



Carriage



Conserbox containers



Easy for external vacuum

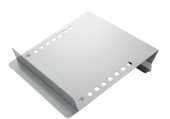

Inclined shelf for liquid products