

CANCAN®

• SINCE 1958 •

İşlerinizi Kolaylaştıran Mutfak Ekipmanları

Horeca Equipment For Professionals

www.cancan.com.tr

CANCAN®

• SINCE 1958 •

İşlerinizi Kolaylaştıran Mutfak Ekipmanları
Horeca Equipment For Professionals



Hakkımızda

CANCAN üretim merkezi Ankara'da olmak üzere 1958 yılında merhum Salih Özüoğurlu tarafından portakal sıkma makineleri, mutfak cihazları tamiri ve ardından da makine üretimiyle gıda sektörüne hizmet etmek üzere kurulmuştur.

1984 yılında 2. Kuşak temsilci olarak işletmenin başına geçen ve yönetimini halen sürdüren Tunç ÖZÜOĞURLU, endüstriyel mutfak sektörünün Türkiye'de giderek gelişeceğini gördü. 1994 yılında firmanın marka tescilini aldı.

Ankara'da İvedik Organize Sanayi Bölgesi'nde bulunan firma, 2000 yılı itibari ile Sakarya'da üretimine devam etmeye başladı. Bugün Sakarya'daki 3200 metrekaarelik üretim tesisinde manuel ve otomatik portakal, nar, grefurt, limon sıkma makineleri, yıkama ekipmanları, konserve açacakları ve soyma makineleri üretimi ile faaliyet gösteren, Cnc tornalar ve frezeler vasıtasıyla metali şekillendirerek üretim yapan CANCAN, boyama ve kaplama aşamaları hariç tüm ürünleri tek çatı altında imal etmektedir.

Firmanın üretim kapasitesi yıllık 50 bin adet civarındadır. İhracata büyük önem veren CANCAN üretiminin yüzde 35'ini ihraç etmektedir. Öncelikli hedefimiz dünyada kalitesi ile aranan bir marka haline gelmektir. 2016 yılından itibaren firmamız her yıl %20 ve %25 oranında artış göstermektedir. 5 kıta ve 30 ülkeye direkt ihracat yapan firma yeni pazar arayışlarını sürdürmeye devam etmektedir.

Araştırma ve geliştirmeye öncelik veren ve yıllık cirosunun önemli bir bölümünü Ar-Ge çalışmalarına ayıran CANCAN, ürettiği inovatif ekipmanlar ile dünya markaları ile rekabet etmektedir. Sektördeki gelişmeler ve talepler doğrultusunda endüstriyel mutfak ürünleri ve gıda makineleri üretiminin yanında Türkiye'de üretilmeyen veya üretimi az olan özel makineleri de imal etmektedir. Ar-Ge departmanında, alanında uzman, yaratıcı, yeniliklere ve gelişime açık, iç ve dış piyasalardaki müşterilerimizin ihtiyaçlarına hızlı çözüm üretebilme kabiliyetine sahip bir kadrosu vardır. Yeni ürünler konusunda Ar-Ge çalışmaları yaparken, kalite alt yapısını da güçlendirmektedir.

Misyonumuz

Müşteri memnuniyeti odaklı çalışarak, kaliteden ödün vermeden dün, bugün ve yarın daima müşterilerin ihtiyaçlarını en kısa sürede karşılamak, müşterilerimiz için değer yaratmak, beklentilerine kalite ve istikrarla karşılık vermek ilk önceliğimizdir. Ürünlerimize sahip çıkmak ve satış sonrasında da müşterilerimizin yanında olmak görevimizdir.

Vizyonumuz

Dünya'ya mal satma değil, dünya'da marka olmak ilkesiyle yoluna devam eden Cancan, uluslararası pazarda, alanında aranan ve tercih edilen bir firma olma yolunda ilerlemektedir.

About Us

CANCAN was founded in 1958 by the late Salih Özüüğürlu in its production center Ankara, in order to serve the food sector with repairing of orange squeezing machines, kitchen appliances and following with the production of these machinery.

As the second generation, Tunç ÖZÜÜĞÜRLU who took over the management in 1984 and continues to manage the company, saw that the foodservice industry would develop more and more in Turkey. In 1994, the company received the trademark registration.

The company located in Ankara, İvedik Organized Industrial Zone, started its production in Sakarya since the year 2000. Today the Company CANCAN, produces manual and automatic orange juicers, pomegranate-grapefruit-lemon juicer machines, washing equipments, can openers and peeler machines in its 3200 squaremeters production facility together with the help of Cnc machines and milling machines by shaping the metals, under one roof.

The company's production capacity is around 50 thousand units per year. CANCAN attaches great importance to exportation and exports 35 percent of its production. Our primary goal is to become a world sought-after brand. Since 2016, our company has increased by 20% and 25% every year. The company, which exports directly to 5 continents and 30 countries, continues to seek new markets.

CANCAN, who gives priority to research and development and allocates a significant part of its annual turnover to R & D activities, competes with global brands with its innovative equipments productions. Besides the productions of the industrial kitchen equipment in accordance with the sectoral developments and demands, the company is producing special machines that has not been produced yet or has been produced in very small quantities in Turkey. The Research and Development Department has a staff who is expert, creative, innovative and open for improvements, capable of producing rapid solutions to the needs of our customers in domestic and foreign markets. The R & D besides studying on new products are also strengthening the quality infrastructure.

Mission

Our first priority is working with a focus on customer satisfaction, without compromising quality, yesterday, today and tomorrow to meet the needs of customers as soon as possible, to create value for our customers, to respond the expectations with quality and stability. It is our duty to own our products and to stand by our customers after sales.

Vision

Cancan, Continuing its journey with the principle of 'not to sell goods to the world but to be a brand in the world' is on its way to becoming a preferred and most wanted company in the international market.

Politikalarımız

Our Policy

Kalite Politikası

Müşteri ve çalışan memnuniyeti odaklı, sıfır hata felsefesiyle, üretim ve hizmet anlayışı sağlamak, Hataları oluşmadan önleyerek ve yapılan hataların tekrarlanmaması için gerekli tedbirleri alarak, kalite yönetim sistemini sürekli iyileştirmek, Gelişen teknolojiyi yakından takip etmek ve bununla birlikte çalışanlarımıza sürekli eğitim vermek Müşterilerimize tam ve doğru hizmet vermek amacı ile tedarikçi firmalarla birlikte sürekli gelişmeyi hedeflemek ve bu vizyona sahip tedarikçi firmalarla çalışmak kalite politikamız olarak belirlenmiştir.

Our Quality Policy

To provide production and service manner by focusing to the customer and employee satisfaction, with zero error philosophy, To continuously improve the quality management system by taking necessary measures to prevent errors from occurring and to avoid duplication of errors, To follow the developing technology closely and to provide continuous training to our employees, In order to provide full and accurate service to our customers, we aim to achieve continuous development together with the suppliers and to work with the suppliers that have this vision is determined as our quality policy.

Kalite Belgelerimiz

Our Quality Certifications



Manuel Meyve Presleri ve Manuel Korseve Açacakları NSF Belgesi

Manual Fruit Juicers and Manual Can Openers NSF Certificate



EUIPO Sertifikası

European Union Intellectual Property Office



Marka Patenti

Trademark Patent



Otomatik Portakal, Nar&Greyfurt CE Belgesi

Automatic Orange, Pomegranate&Grapefruit CE Certificate

Çevre Politikası

Hammadde işleme ve üretim aşamalarında sürdürülebilir çevre, ilke ve hedeflerine ulaşabilmek için gerekli teknik gelişmeleri uygulayarak çevresel riskleri önleyecek bir kaynak ve atık yönetimi sistemi ile sürekli gelişmeyi hedeflemektedir.

Bu çerçevede;

Her bir üretim ve nakliye aşamasında oluşabilecek atık miktarlarını kaynak tüketimimizi izleyerek mali ve teknik destek ile kaynağında azaltmayı ve geri kazanma konusunda çalışmalar yapmayı, geri dönüşüm ve/veya bertaraf işlemlerini çevreye mümkün olan en az zarar verecek şekilde yerine getirmek,
Enerji kaynaklarını ve oluşabilecek kaçakları yönetmek,
Çevre ve atık yönetimi konusunda çalışanlarımızı bilinçlendirmek,
Çalışanlar ile çevre hassasiyetimizin devamı için sürekli iyileştirme çalışmaları yapmak,
Kalıcı çözümlerle çevre kirlenmesini önlemeye çalışmak,
Sürdürülebilir kaynakların kullanımına önem vererek ekosistemlerin korunmasını sağlamak,
Çeşitli sosyal sorumluluk projelerinde çevreye karşı duyarlılığımızı yaymak için gerekli altyapının oluşturulmasına önem vermek,
Çalışanlarımızın ve paydaşlarımızın çevre bilincini artırmak başlıca sorumluluğumuzdur.

Environmental Policy

In order to reach sustainable environment targets at the stages of raw material process and production, the required techniques are implemented to prevent environmental risks and aim to develop sustainable resource and waste management. In this context; To reduce the maximum quantity of waste at the process of manufacturing and transportation at its source by monitoring with financial and technical support and to minimize the effects of recycle, regain systems to environment, to work at recycling and waste management systems.
To manage energy sources and leakages that can occur,
To raise awareness of our employees on environment and waste management,
Continuous improvement works for the continuation of our environmental sensitivity with employees,
To try to prevent environmental pollution with permanent solutions,
To ensure the conservation of ecosystems by giving importance to the use of sustainable resources,
To give importance to the establishment of the necessary infrastructure to disseminate our sensitivity to the environment in various social responsibility projects,
Our primary responsibility is to increase the environmental awareness of our employees and stakeholders.

İş Sağlığı ve Güvenliği Politikası

Tüm çalışanlarımızın iş güvenliği konusunda eğitilmesini sağlamayı,
Faaliyetlerimizden kaynaklanabilecek iş kazaları, meslek hastalıkları ve çevre kirlenmesini önlemek için gerekli tedbirleri almayı,
İş sağlığı ve güvenliği performansını her alanda sürekli iyileştirmeyi ve bu kapsamda; iş sağlığı ve güvenliği hedefleri oluşturmayı, iş planlarında ve kişisel teşvik düzenlemelerinde eylem planlarına ve ölçülebilir iş sağlığı ve güvenliği hedeflerine yer vermeyi,
İlgili tüm yasal mevzuatlara uymada gereken hassasiyetleri göstermeyi,
Acil durumlara müdahale ve kriz yönetimi gerektiren durumlara yönelik yeterli planlama ve hazırlık yapmayı,
Sağlık ve güvenlik risklerinin önleyici faaliyetlerini kalite sistemi dokümantasyonlarının ve karar alma süreçlerinin parçası haline getirmeyi,
Sağlık ve güvenlik performansımızı sürekli iyileştirmeyi taahhüt ederiz.

Occupational Health and Safety Policy

To ensure that all of our employees are trained in occupational safety,
To take necessary measures to prevent occupational accidents, occupational diseases and environmental pollution that may arise from our activities,
To continuously improve occupational health and safety performance in all areas and in this context; to create occupational health and safety targets, to include action plans and measurable occupational health and safety targets in business plans and personal incentive regulations,
To demonstrate the sensitivity required to comply with all relevant legislation,
Adequate planning and preparation for situations requiring emergency response and crisis management,
Making preventive activities of health and safety risks part of quality system documentation and decision making processes,
We are committed to continuously improving our health and safety performance.

Ürünlerimiz

Our Products

Manuel Meyve Presleri

Manual Fruit Juicers

 Sayfa 11

Ev Tipi Domestic Type



Profesyonel Tip Professional Type



Nar Tipi Pomegranate Type



Otomatik Portakal Sıkma Makinaları

Automatic Orange Juicer Machines

 Sayfa 19

Otomatik Nar Sıkma Makineleri

Automatic Pomegranate Juicer Machines

 Sayfa 38

Bardaklı With Glass



Depolu Arabalı With Glass and Stand



Hidrolik Nar Sıkma Presi

Hydraulic Pomegranate Press

 Sayfa 42

Hidrolik Nar Presi Pomegranate Press



Manuel Konserve Açacakları

Manual Can Openers

 Sayfa 60

Profesyonel Model Professional Model



Diamond Model Diamond Model



Ön Yıkama Duşları

Pre-Rinse Faucets

 Sayfa 67

Tezgaha Monte Sink Mounted



Geri Toplamalı Yıkama Duşları

Retractable Pre-Rinse Faucets With Reel Hose

 Sayfa 72

2 Metre 2 Meters



6 Metre 6 Meters



10 - 15 Metre 10 - 15 Meters



28 - Cafe Tipi

Cafe Type



38 - Bardaklı

With Glass



38 - Fresh

Fresh Type



38 - Depolu

With Tank



38 - Soğutmalı

With Cooler



Ananas Soyma Makinesi

Pineapple Peeler Machine

 Sayfa 46

Ananas Soyma

Pineapple Peeler



Elektrikli Konserve Açacakları

Electrical Can Openers

 Sayfa 52

Dairesel & Kare

Circle & Square Cut



Dairesel

Circle Cut



Tezgaha Monte Ara Musluklu

Sink Mounted With Intermediate Tap



Duvara Monte

Wall Mounted



Duvara Monte Ara Musluklu

Wall Mounted With Intermediate Tap



Mini Boy Eviye

Mini Size Sink Type



Mini Boy Eviye Ara Musluklu

Mini Size Sink Type With Intermediate Tap



Kazan Yıkama Makinesi

Pot Washing Mashine

 Sayfa 76

Kazan Yıkama

Pot Washing Mashine



CANCAN®

• SINCE 1958 •

Hedef ve İlkelerimiz

Our Goals and Principles

Müşteri Memnuniyetini Sürdürülebilir Kılmak

Müşterilerimiz için değer yaratmak, kaliteli çözümler sunmak beklentilerine kalite ve sürdürülebilir bir anlayışla karşılık vermek ilk önceliğimizdir. Ürün ve hizmetlerimizin her daim arkasında durarak müşteri memnuniyetini sağlamayı hedeflerimiz arasında en başta tutmaktayız.

Kalitede, hizmette ve bayi ilişkilerimizde en iyi olmak ana hedefimizdir. Bu hedefe ulaşmak üzere faaliyet gösterilen alanlarda yönetimi üstlenmek ve piyasada lider olmak temel ilkemizdir.

Making Customer Satisfaction Sustainable

Our first priority is; to create value for our customers, to provide quality solutions, to respond to expectations of quality and sustainable understanding. We keep customer satisfaction first among all our goals by always standing behind our products and our services. Our main goal is to be the best in quality, service and our dealer relations. In order to achieve this goal, it is our basic principle to undertake management in the fields of activity and to be a leader in the market.

İş Ahlakı ve Dürüst Çalışma

Tüm ilişkilerimizde adilane, karşılıklı yarar sağlamak amacıyla, iyi niyet ve anlayışla davranmak, yasalara ve ahlak kurallarına daima uymak ilkemizdir. Bugünün insanına ve gelecek kuşaklara karşı sorumluluklarımızı yerine getirmek, öncüsü olduğumuz ve vazgeçemeyeceğimiz bir başka temel ilkemizdir. Türkiye ve Dünya için, çevre koruma bilinciyle davranmak ve bu bilinci yaymak görevimizdir.

Business Ethics and Honest Work

In all our relations, we are always committed to behave in good faith and understanding and to always comply with laws and codes of ethics in order to ensure mutual benefit. To fulfill our responsibilities to today's people and to future generations is our other principal that we are a pioneer and won't give up. Our mission is to act with environmental awareness and to spread this conscious for the benefits of Turkey and worldwide

Sürekli Gelişmek ve İnovatif Olmak

Hizmetlerin sürekliliğini sağlamak için yenilikçi düşünce vazgeçemeyeceğimiz bir olgudur. Tüm kaynakların akılcı kullanılarak gelişimin desteklenmesi sürdürülebilir başarının tek anahtarı olarak karşımıza çıkmaktadır.

Continuously Improving and Being Innovative

To ensure the continuity of services, innovative thinking is a fact that we can not give up. Supporting the development of all resources rationally is the only key to sustainable success.

Ülkemiz Ekonomisine Katkı Sağlamak,

Ülkemiz ekonomisine katkı sağlamak amacıyla elimizden gelen tüm gayreti göstermek, güçlü ekonominin güçlü demokrasi getireceği inancı doğrultusunda çalışmalarımızı sürdürmek ana prensiplerimiz arasındadır.

Contributing to the Economy of Our Country

Our main principles are to show all our efforts in order to contribute to the economy of our country and to continue our activities in line with the belief that strong economy will bring strong democracy.



CANCAN[®]
Manuel Meyve Presleri
Manual Fruit Juicers

Manuel Meyve Presleri Teknik Özellikleri

Manual Fruit Juicers Technical Specifications

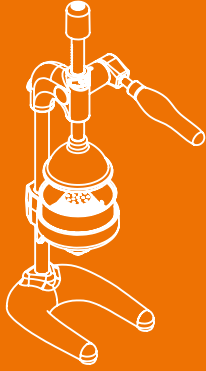

Ev Tipi
Domestic Type

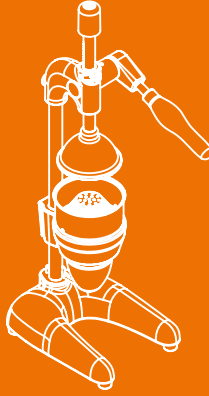

Profesyonel Tip
Professional Type

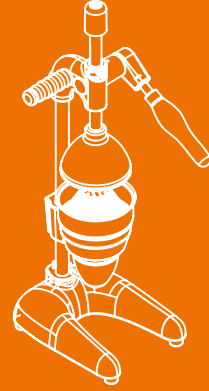

Profesyonel Nar Tipi
Professional Pomegranate Type

Ürün Kodu

Product Code

0101

0102

0103

Ağırlık / Weight

4 kg

5,5 kg

6 kg

Genişlik / Width

17 cm

19 cm

20 cm

Yükseklik / Height

48 cm

55 cm

55 cm

Derinlik / Depth

28 cm

29 cm

30 cm

Daha Çok İş... Daha Az Enerji

More Work... Less Energy



0102
Profesyonel Tip
Professional Type

0101
Ev Tipi
Domestic Type

0103
Nar Tipi
Pomegranate Type

Manuel Meyve Presleri
Manual Fruit Juicers

Manuel Meyve Presleri Genel Özellikleri

Manual Fruit Juicers
General Features



Manuel Meyve Presleri Ortak Özellikleri

Manual Fruit Juicers Common Features



Manuel meyve presleri portakal, nar, greyfurt, limon ve mandalina gibi narenciyelerin fazla güç gerektirmeden, zaman tasarrufu sağlayarak en verimli şekilde sıkılması için tasarlanmıştır. Ergonomik yapısıyla kullanıcıya avantaj sağlamaktadır. Kullanımı ve temizliği kolaydır.

Manual fruit juicers are designed to squeeze citrus fruits such as oranges, pomegranates, grapefruits, lemons and tangerines the most productive way to save time, without the need of extra power. The ergonomic structure provides advantage to the user. Usage and cleaning is easy.

NSF Ulusal Hijyen Sertifikası (NSF) National Sanitation Foundation (NSF)

Tamamen gıdaya uygun olan manuel meyve presleri; ürünün bütün parça ve hammaddelerinin insan sağlığına uygunluk belgesi olan NSF sertifikası ile belgelenmiştir.

Manual fruit juicers which are completely suitable for food, are certified by the NSF certificate, which is a certificate of conformity to human health, with all parts and raw materials of the product.

Ergonomik Çevirme Kolu Ergonomic Rotation Arm

Özel dizayn edilmiş çevirme kolu 2 tur dönerek fazla güç gerektirmeden sıkımı gerçekleştirir ve zaman tasarrufu sağlar.

Ergonomik tasarlanmış çevirme kolu ile birim alana 90 kg'lık sıkma kuvveti uygulanmaktadır.

The special designed rotation arm provides the user to squeeze the fruits without using extra power and time saving by turning it 2 rounds.

The ergonomically designed arm applies 90 kg of squeezing force to the unit area.



Genişletilmiş İç Hacim

Expanded Internal Volume

Süzgeci tam kavrayan ve tase tam oturan üst baskı sayesinde büyüklüğü mevsimine göre değişen meyvelere tam uyum sağlar. Bu sayede her sıklıkta muadillerine göre %30 kazanç elde edilir.

Thanks to the upper press that grips the strainer wholly and is settled completely on the bowl, it provides the optimum squeezing process. Thanks to the expanded volume of the bowl and the standard distance between the upper press and the strainer, it provides a comfortable and effective operation.



Kilitli Paslanmaz Süzgeç

Locking Stainless Strainer

Tasın iki tarafına yapılan tırnaklarla süzgeç tase kilitlenmektedir. Böylece sıkım esnasında süzgecin meyve kabuğuna yapışarak havaya kalkması önlenmiştir.

Paslanmaz çelik malzemeden üretilmiş süzgeç, kademeli ve açılı delik sistemi sayesinde yüksek sıkma performansı sağlar. Genişletilmiş dizaynı ile posa miktarını minimuma indirir. Bulaşık makinesinde rahatlıkla yıkanabilir.

The strainer is locked to the bowl with the help of connecting tabs made on both sides of the bowl. This prevents the strainer from rising up by sticking to the fruit pulp during the squeezing process.

The strainer made of stainless steel, provides high squeezing performance thanks to its gradual and angled hole system. The expanded design reduces the amount of pulp to a minimum level. It can be easily washed in the dishwasher.



Kilitli Paslanmaz Tas Locking Stainless Bowl

Tasın altında bulunan kilit, döküm çanağa kilitlenir ve sıkım esnasında tasın çanaktan ayrılmasını engeller.

The fixing add-on that is underneath the bowl is locked to the bowl pool and prevents the bowl separating from the bowl pool during squeezing process.



Damlalık Dropper

Damlalık sayesinde sıkım aralarında meyve suyunun dışarı akması önlenmiş olur.

Thanks to the dropper, it is prevented from dropping the juice between squeezing processes.



Plastik Tabanlıklar Plastic Bases

Kaymayı önleyici plastik tabanlıklar sayesinde, meyve presi zemine tam oturarak kolay bir sıkım pozisyonu sağlamış olur.

Thanks to the anti-slip plastic base, the juicer will be fully seated to the floor and this will provide an easy squeezing process.



Manuel Meyve Presleri Ayırıcı Özellikleri

Manual Fruit Juicers Specific Features



0101 - Ev Tipi Meyve Presi Domestic Type Manual Fruit Juicer

Kilitli sistemli Süzgeç'e sahiptir.
It has a strainer with a locking system.

Tas, Süzgeç ve üst baskı çapı 10 cm'dir.
The bowl, the strainer and the upper press's diameters are 10 cm.

Ev kullanıcıları için küçük boy tasarlanmıştır.
It is made for domestic users and smaller in size than the other models.



0102 - Profesyonel Tip Meyve Presi Professional Type Manuel Fruit Juicer

Kilitli sistemli Süzgeç ve Tas'a sahiptir.
It has a strainer and a bowl both with a locking system.

Tas, Süzgeç ve Üst baskı çapı 10 cm'dir.
The bowl, the strainer and the upper press's diameters are 10 cm.

Sıkım aralarında meyve suyunun dışarı akmasını önleyen damlalık mevcuttur.
It has a dropper that prevents dropping the juice between squeezing processes.

Cafe, büfe, restaurant gibi mekanlarda kullanılmak üzere tasarlanmıştır.
It is designed to be used at places such as Cafes, kiosks, restaurants.



0103 - Profesyonel Tip Nar Presi Professional Type Pomegranate Juicer

Kilitli sistemli Süzgeç ve Tas'a sahiptir.
It has a strainer and a bowl both with a locking system.

Büyük olan narların daha kolay sıkılabilmesi için Tas, Süzgeç ve Üst Baskı çapı 11,5 cm olarak tasarlanmıştır.
The bowl, strainer and upper press are designed as 11,5 cm diameter to squeeze the big sized pomegranates easier.

Sıkım aralarında meyve suyunun dışarı akmasını önleyen damlalık mevcuttur.
It has a dropper that prevents dropping the juice between squeezing processes.

Tutma kolu sıkım esnasında kullanıcıya kolaylık sağlamak amacıyla tasarlanmıştır.
The handle is designed to provide the user convenience during squeezing process.

Cafe, büfe, restaurant gibi mekanlarda kullanılmak üzere tasarlanmıştır.
It is designed to be used at places such as Cafes, kiosks, restaurants.



0101 - Ev tipi Süzgeç ve Tas
Domestic Type Strainer and Bowl



0102 - Profesyonel Tip Süzgeç ve Tas
Professional Type Strainer and Bowl



0103 - Profesyonel Nar Tipi Süzgeç ve Tas
Professional Type Pomegranate Strainer and Bowl



CANCAN[®]

Otomatik Portakal Sıkma Makineleri
Automatic Orange Juicer Machines

Otomatik Portakal Sıkma Makineleri Karşılaştırma Tablosu

Automatic Orange Juicer Machines Comparison Chart



0206

Cafe Tipi Cafe Type



0203

Bardaklı With Glass



0204 - 1101

Depolu Arabalı With Tank and Stand

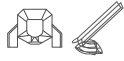

Meyve Depolama Haznesi Fruit Storage Basket

Standart olarak 15 kg ve opsiyonel olarak 28 kg kapasiteye sahip meyve depolama haznesi.
Standard capacity of 15 kg and optional capacity of 28 kg fruit storage basket.



Geniş Hacimli Posa Kovası Large Volume Trash Can

70 kg'a kadar posa depolama haznesi.
Fruit Peel Storage reservoir with up to 70 kg capacity.



Soğutucu Sistem Cooler System

Tabandan soğutma sistemi ile içeceği son damlasına kadar eşit olarak soğutan, 7 litre meyve suyu depolama kapasitesine sahip soğutuculu depo.

Cooler Tank with a bottom cooling system that cools the juice equally until the last drop and with a juice storage capacity of 7 liters.



Güvenlik Switch'li Ön Kapak Front Cover with a Safety Switch

Dayanıklı polikarbonattan yapılmış ön kapakta bulunan güvenlik switch'leri sayesinde kapak açıkken çalışmayı önleyen sistem.

System that prevents operating of the machine while the front cover is open thanks to the safety switch, located on the front cover made of durable polycarbonate.



Meyve Suyu Biriktirme Deposu Juice Gathering Tank

Gıda standartlarına uygun 5 lt kapasiteli depo.
5 lt capacity juice tank in accordance with food standards.



Self Servis Sistemi Self Service System

Tamamı 304 paslanmaz çelikten üretilmiş self servis sensörlü musluk ile musluğa basınca sıkma işlemi yapıp, bırakınca duran sistem

System that starts the squeezing process when tap is pressed and stops when tap is released with the self service sensor tap made of 304 stainless steel.



0205 - 1101
Fresh Arabalı
Fresh Model With Stand



0208
Soğutmalı
Cooler Model



0207 - 1107
Çift Posa Kovalı
Double Trash Can and Stand

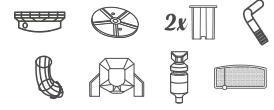
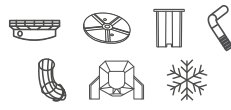
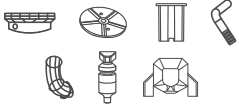

Çevirici Disk Rotating Disk

Portakalları döndürerek tek tek yolluğa düşmesini sağlayan sistem.

A system that makes the oranges falling into the feeding wire one by one by rotating the oranges.



Geniş Besleme Teli Large Feeding Wire

Çapı 10 cm genişliğine sahip yan besleme teli.

Diameter of 10 cm side feeding wire.



Tahliye Borusu Draining Pipe Tube

Biriken meyve suyunun makineye zarar vermemesi için tasarlanmış tahliye borusu.

The accumulated fruit juice is discharged from the machine by the draining pipe tube to prevent damage to the machine.



Çift Posa Kovası Double Trash Can

70 kg posa biriktirme kapasitesine sahip iki adet posa kovası.

Double Trash Can with a capacity of 70 kg of fruit peel.



Meyve Besleme Teli Fruit Feeding Wire

6 ile 8 adet portakal depolama imkanı.

6 to 8 oranges storage capacity in the feeding wire.

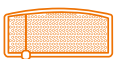

Kolay Temizlenen Paslanmaz Süzgeç Easily Cleanable Stainless Steel Strainer

Üstünde biriken posayı tek hamleyle sağa veya sola çekerek posa kovalarına atabileceğiniz tamamı paslanmaz süzgeç.

All stainless Steel strainer where you can clean the fruit pulp easily that is accumulated on the strainer by pulling it right or left with one single movement.

Cafe Tipi Genel Özellikleri 0206

Cafe Type General Features

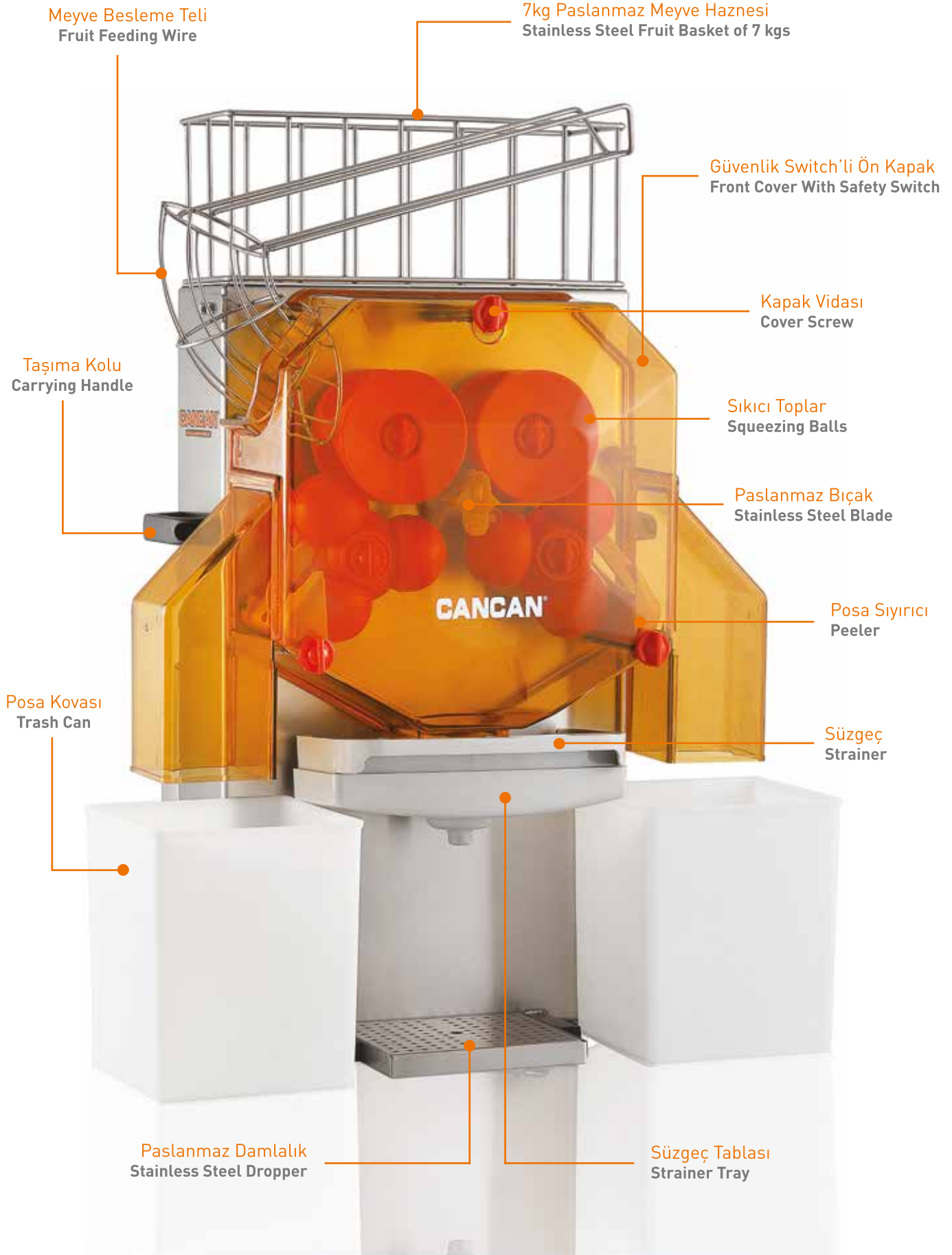

Cafe Tipi Ayırıcı Özellikleri

Cafe Type Specific Features

Cafe tipi otomatik portakal sıkma makinesi; restoran, cafe, büfe, okul gibi mekânlarda portakal, mandalina ve limon meyvelerinin suyunun sıkılması için tasarlanmıştır.

Verim ve yüksek randıman avantajlarının yanında, hijyen ve güvenlik gereksinimlerini de sağlar.

The Cafe Type Automatic Orange Juicer Machine is designed to squeeze citrus fruits like oranges, mandarins and lemons in public places such as restaurant, cafe, kiosk and school canteens.

Along with high production rate and efficiency it also provides hygiene and safety requirements.

Paslanmaz Meyve Haznesi

Stainless Steel Fruit Basket

Paslanmaz meyve haznesi 7 kg portakal depolama kapasitesine sahiptir.

Meyve besleme teli 6 ile 8 adet arasında portakal alır.

The stainless steel fruit basket has a 7 kg orange storage capacity. The fruit feeding wire can take 6 to 8 oranges.



Bardaklı - Depolu Genel Özellikleri 0203 - 0204

With Glass - With Tank General Features



Yan Besleme Teli
Side Feeding Wire

15kg Meyve Depolama Haznesi
Fruit Storage Basket of 15 kgs

Güvenlik Switch'li
Ön Kapak
Front Cover With a
Safety Switch

Kapak Vidası
Cover Screw

Sıkıcı Toplar
Squeezing Balls

Paslanmaz Bıçak
Stainless Steel Blade

Posa Sıyrıcı
Peeler

Posa Kovası
Trash Can

Süzgeç
Strainer

Paslanmaz Damlalık
Stainless Steel Dropper

Süzgeç Tablası
Strainer Tray



Bardaklı - Depolu Ayırıcı Özellikleri

With Glass - With Tank Specific Features

Bardaklı ve tercihe göre depolu otomatik portakal sıkma makinesi; restoran, otel, cafe, büfe, üretim tesisleri gibi mekânlarda portakal, mandalina ve limon meyvelerinin suyunun sıkılması için tasarlanmıştır.

Tamamen otomatik olan bu ürün besleme, kesme, sıkma, posayı suyundan ayırma ve meyve suyunu depolama işlemlerini yapar.

Dakikada 38 adet portakal, mandalina ve limon sıkma kapasitesine sahip olan bu ürün hızlı, temiz ve kolay kullanım sağlar.

The automatic orange juicer machine with glass and if preferred with stand; are designed to squeeze citrus fruits like oranges, tangerines and lemons in public places such as restaurant, hotel, cafe, kiosk and production facilities.

This fully automatic product; feeds, cuts and squeezes the oranges, removes the juice from the pulp and collects the juice.

This product, capable of squeezing 38 oranges, tangerines and lemons per minute, is fast and provides you clean and easy usage.



Meyve Suyu Deposu

Juice Tank

5 lt meyve suyu depolama kapasitesine sahip, gıda standartlarına uygun musluklu depo yoğun mekânlarda için oldukça avantaj sağlar.

Depolu model, mobil araba ile kullanılmaktadır. Mobil arabada 70 kg'lık posa biriktirme kapasitesine sahip posa kovası mevcuttur. Mobil arabadaki frenli tekerlekler sayesinde makineyi istediğiniz yere kolay bir şekilde taşıyabilirsiniz.

With its 5 lt juice storage capacity, the tank with the faucet according to the food standards, offers a great advantage for busy places.

The model with tank will be used together with the mobile stand. The mobile stand has a trash can with a capacity of up to 70 kg of fruit peels. Thanks to the brakes on the mobile stand, you can easily move the machine wherever you want.





Fresh Model Genel Özellikleri 0205

Fresh Model General Features

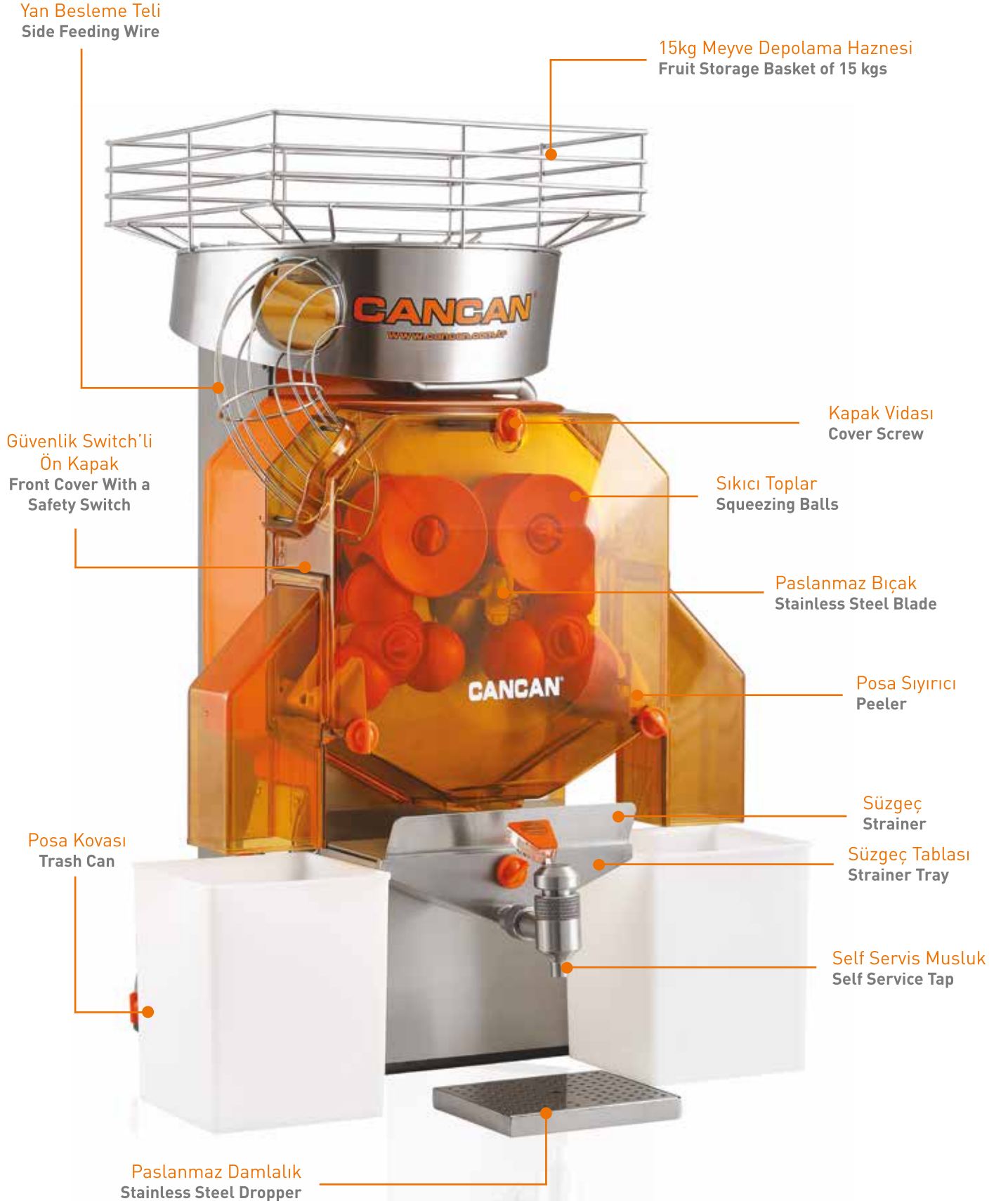

Fresh Model Ayırıcı Özellikleri

Fresh Model Specific Features

Fresh model otomatik portakal sıkma makinesi; market, alışveriş merkezi, hastane, öğrenci yurtları, cafe gibi mekânlarda portakal, mandalina ve limon meyvelerinin suyunun sıkılması için tasarlanmıştır.

The Fresh Model automatic orange juicer machine is designed to squeeze citrus fruits like oranges, tangerines and lemons in public places such as supermarket, shopping mall, hospital, dormitory and cafes.

Paslanmaz Süzgeç ve Süzgeç Tablası

Stainless Steel Strainer and Strainer Tray

Tamamen paslanmaz süzgeç ve paslanmaz süzgeç tablası ile daha uzun ömürlü kullanım sağlar.

It provides long-lasting usage with the all stainless steel strainer and the strainer tray.



Paslanmaz Self - Servis Musluk

Stainless Steel Self Service Tap

Self servis musluğu sayesinde anında taze sıkım yapabilirsiniz. Paslanmaz musluğa bastığınız anda sıkım işlemi yapıp bıraktığınız anda sıkımı durduran sisteme sahiptir.

Thanks to the self service tap you can instantly squeeze fresh juice. It has a system that starts the squeezing process when tap is pressed and stops when tap is released.





Soğutuculu Model Genel Özellikleri 0208

Cooler Model General Features



Soğutuculu Model Ayırıcı Özellikleri

Cooler Model Specific Features

Soğutuculu model; cafe, restoran, otel, market, okul, hastane gibi mekânlarda portakal, mandalina ve limon meyvelerinin suyunun sıkılması ve meyve suyunu soğutması için tasarlanmıştır.

The Cooler Model is designed to squeeze citrus fruits like oranges, tangerines and lemons and to cool the fruit juice in public places such as cafe, restaurant, hotel, supermarket, school canteen and hospitals.



Soğutma Sistemi

Cooler System

Tabandan soğutma sistemi ile içeceği son damlasına kadar eşit olarak soğutan, 7 litre meyve suyu depolama kapasitesine sahip soğutma sistemi mevcuttur.

Dijital termostat ile içeceğin anlık sıcaklığını gösterir.

It has a cooling system that cools the juice equilly until the last drop thanks to the bottom cooling system with a juice storage capacity of 7 liters.

The digital thermostat shows the instantaneous temperature of the beverage

Taşınabilir Mobil Araba

Portable Mobile stand

150 lt meyve posası biriktirme haznesine sahip mobil araba tamamen paslanmazdır.

Mobil arabadaki frenli tekerlekler sayesinde makineyi istediğiniz yere kolay bir şekilde taşıyabilirsiniz.

The mobile stand with a 150 lt of fruit peel storage capacity is completely stainless.

Thanks to its braked wheels it is possible to settle the mobile stand wherever you desire.

Çift Posa Kovalı Genel Özellikleri 0205 - 1107

Model With Double Trash Can General Features

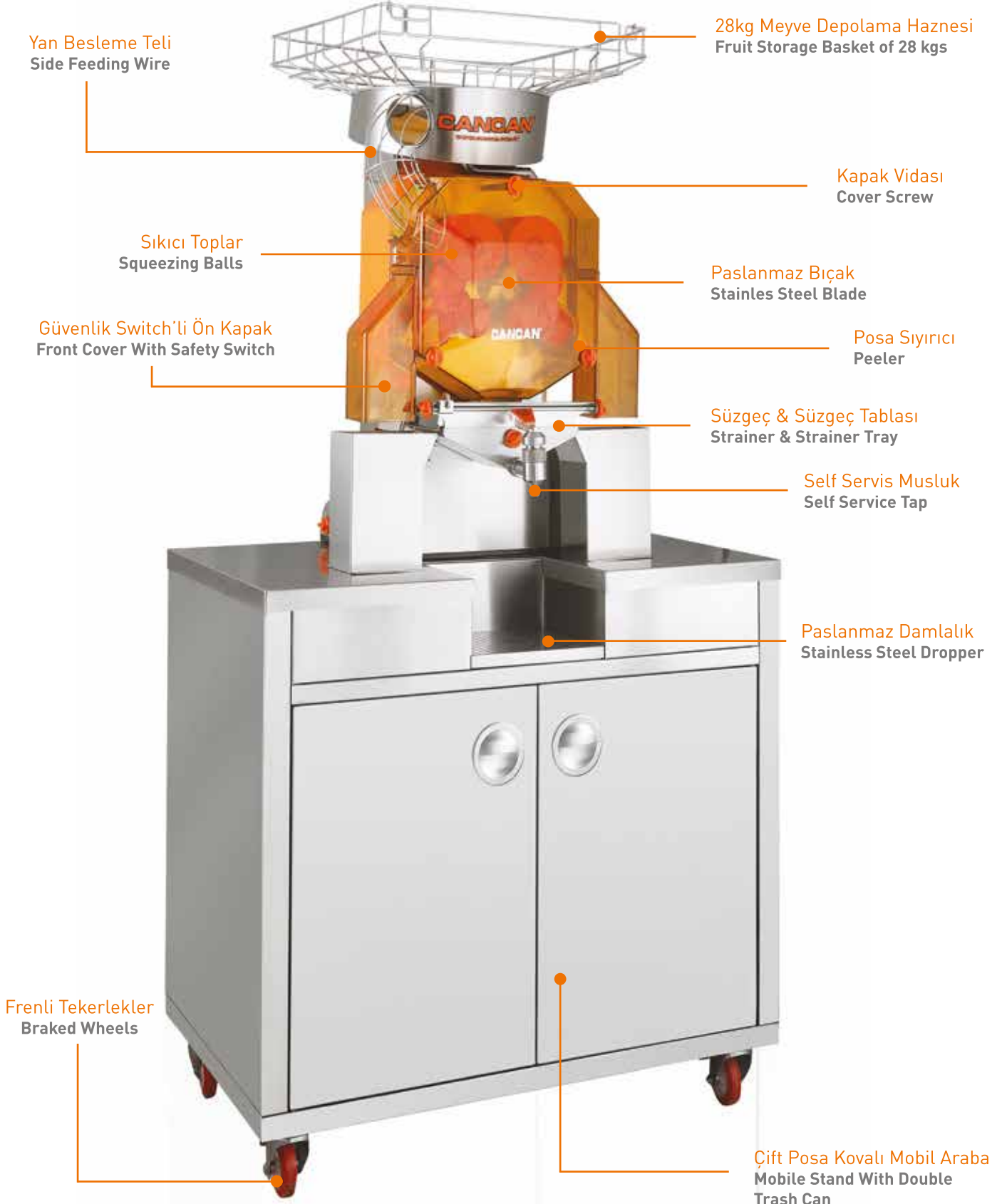

Çift Posa Kovalı Ayırıcı Özellikleri

Model With Double Trash Can Specific Features

Çift Çöp Kovalı Arabalı Fresh model otomatik portakal sıkma makinesi; market, alışveriş merkezi, hastane, öğrenci yurtları, gibi yoğun mekânlarda portakal, mandalina ve limon meyvelerinin suyunun sıkılması için tasarlanmıştır.

The Fresh Model Automatic Orange Juicer Machine with the Double Trash Can Mobile Stand is designed to squeeze citrus fruits like oranges, tangerines and lemons in public places such as supermarket, shopping mall, hospital and dormitories.

Self Servis Musluk

Self Service Tap

Self servis musluğu sayesinde anında taze sıkım yapabilirsiniz. Paslanmaz musluğa bastığınız anda sıkım işlemi yapıp bıraktığınız anda sıkımı durduran sisteme sahiptir.

Thanks to the self service tap you can instantly squeeze fresh juice. It has a system that starts the squeezing process when tap is pressed and stops when tap is released.



Kolay Temizlenen Paslanmaz Süzgeç

Easily Cleanable Stainless Steel Strainer

Üstünde biriken posayı tek hamleyle sağa veya sola çekerek posa kovalarına atabileceğiniz tamamen paslanmaz süzgece sahiptir.

It has an all stainless steel strainer where you can clean the fruit pulp easily that is accumulated on the strainer by pulling it right or left with one single movement.



Posa Depolama Alanı

Fruit Peel Storage Reservoir

70'er kg posa biriktirme kapasitesine sahip 2 adet posa kovası, toplamda 140 kg posa biriktirerek ekstra zaman tasarrufu sağlar.

The double Trash Can with a capacity of up to 70 kg each, totally 140 kg of fruit peel, will save you extra time.



Otomatik Portakal Sıkma Makineleri Ortak Özellikleri

Automatic Orange Juicer Machines Common Features

Meyve Depolama Haznesi

Fruit Storage Reservoir

Paslanmaz meyve depolama haznesi standart olarak 15 kg ve opsiyonel olarak 28 kg kapasiteye sahiptir.

It has a stainless steel fruit storage reservoir of a standard capacity of 15 kg and optional capacity of 28 kg.



Çevirici Disk

Rotating Disk

Meyve depolama haznesi içindeki çevirici disk meyveleri haznesinde döndürerek tek tek yolluğa düşmesini sağlar.

The rotating disk that is in the fruit storage reservoir makes the oranges falling into the feeding wire one by one by rotating the oranges.



Sıkıcı Toplar

Squeezing Balls

Gıdaya uygun malzemeden üretilmiş sıkıcı toplar meyveyi kavrayarak tam verimli sıkılmasını sağlar. Bulaşık makinesinde yıkanabilir.

The squeezing balls made of material that is suitable for food, grasp the fruit and ensure efficient squeezing of fruits. Dishwasher-Safe.



Sıyırıcılar

Peelers

Meyvelerin posalarını suyundan ayırarak posa kovalarına dökülmesini sağlar. Bulaşık makinesinde yıkanabilir.

Provides to separate the orange peel from the juice and make them fall into the trash cans. Dishwasher-Safe.



Paslanmaz Bıçak

Stainless Blade

Özel lazer kesim paslanmaz bıçak, 6 ile 8 cm çapındaki meyveleri ezmeden ikiye bölerek tam verimli sıkım sağlar. Bulaşık makinesinde yıkanabilir.

The special laser cut stainless blade, provides to squeeze the oranges efficiently of 6-8 cm diameters by cutting them in half without smashing. Dishwasher-Safe.



Süzgeç & Süzgeç Tablası

Strainer & Strainer Tray

Meyve posasını süzen, gıda standartlarına uygun süzgeç ve süzgeç tablası özel olarak tasarlanmıştır. Bulaşık makinesinde yıkanabilir.

Strainer and strainer tray according to the Food Standards, that filters the fruit pulp are specially designed. Dishwasher-Safe.



Güvenlik Switch'li Ön Kapak

Front Cover With Safety Switch

Dayanıklı polikarbonattan yapılmış kapak, meyve suyunun dışarı sıçramasını önler. Üründe bulunan güvenlik switch'leri sayesinde kapak açıkken makine çalışmaz ve herhangi bir iş kazasına neden olmadan güvenli bir şekilde sıkım yapar.

The front cover made of durable polycarbonate, prevents the splashing of the juice. Thanks to the safety switch on the cover, the machine won't operate if the cover isn't settled and provides a safe squeezing process without causing any work accidents.



Paslanmaz Damlalık

Stainless Steel Dropper

Paslanmaz damlalık bardak ve şişe ebatlarına göre yüksekliği ayarlanabilir şekilde tasarlanmıştır. Bulaşık makinesinde yıkanabilir.

The stainless dropper is designed adjustable to the heights of cup and bottle. Dishwasher-Safe.



Tahliye Borusu

Draining Pipe Tube

Çevirici disk'te yer alan meyvelerin bazıları yumuşak olmasından dolayı patlamakta ve suyu haznenin içinde birikmektedir. Biriken meyve suyunun makineye zarar vermemesi için tahliye borusu ile makineden dışarı atılır.

Some of the fruits in the rotating disc are exploding due to their softness and their juices accumulates inside the basket. The accumulated fruit juice is discharged from the machine by the draining pipe tube to prevent damage to the machine.



Posa Kovaları

Trash Cans

Tezgah üstü makinelerde bulunan iki adet beyaz posa kovaları 8'er kg posa depolama kapasitesine sahiptir.

The two White colour trash cans that will be given together with the counter top machines have a capacity of 8 kg each.



Kilitlenebilir Frenli Tekerlekler

Lockable Braked Wheels

Mobil arabadaki kilitlenebilir frenli tekerlekler sayesinde makineyi istediğiniz yere kolaylıkla taşıyabilir ve sabitleyebilirsiniz.

Thanks to the lockable braked wheels on the mobile stand, you can easily move and fix the machine wherever you desire.



Butonu Koruyucu Kılıf

Protective Button Cover

Koruyucu kılıf açma kapama butonunu sıvı temasından korumaktadır.

The protective cover protects the on-off button from liquid contact.







CANCAN®

Meyve Suyu Üretim Tesisi Fruit Juice Production Facility

Portakal suyu üretimi yapan profesyonel tesisler için tasarlanmış olan Yükleme Bunkerleri ile her makine günlük ortalama 2 - 2,5 ton portakal suyu sıkımı yapılabilmektedir. Bu sayede zaman kayıpları ve işçilik giderleri minimuma indirilir.

With the loading bunker designed for professional facilities producing orange juice, every machine can produce 2 - 2.5 tons of orange juice per day. Thus, time losses and labor costs are minimized.

Yükleme Bunkeri Genel Özellikleri 0401

The Loading Buncer General Features



Acil Durum Stop Butonu
Emergency Case Stop Button

Taşıyıcı
Conveyor Chain

Meyve Depolama Haznesi
Fruit Storage Reservoir

Frenli Tekerlekler
Braked Wheels

Yükleme Bunkeri Hakkında

About The Loading Buncer

40-50 kg portakal depolama kapasitesine sahip paslanmaz yükleme bunkeri, portakal sıkma makinesinin meyve haznesine devamlı portakal depolar.

Zaman kayıplarını ve işçilik giderlerini minimuma indirmekte olan yükleme bunkeri, portakal suyu üretimi yapan profesyonel tesisler için tasarlanmıştır.

Acil durumlar için makineyi durduran acil durum stop butonu mevcut olan bu ürün, kilitlenebilir frenli tekerleklere sahiptir.

The stainless loading buncer with a 40-50 kg orange storage capacity, continuously stores orange in the fruit storage reservoir of the orange squeezer.

The loading buncer, which minimizes time losses and labor costs, is designed for professional facilities producing orange juice.

This machine that has an emergency stop button, which stops the machine in cases of emergency, has also lockable braked wheels.



Şişelik Hakkında

About The Bottle Stand

Marketler, alışveriş merkezleri, oteller ve self servis için son derece uygun ve kullanışlı olan bu ürün; tüketiciye taze ve doğal meyve suyunu sıkıp-içme ve şişelere doldurup yanında götürme avantajı sunmaktadır.

Self servis sıkım yapan mekanlarda ihtiyaç duyulan şişelerin depolandığı paslanmaz şişeliktir.

Paslanmaz şişelik sayesinde, müşteri istediği boyuttaki şişeye taze meyve suyunu kendisi sıkabilir ve güvenle içebilir.

This product is extremely convenient for grocery stores, shopping centers, hotels and self service places.

It offers the consumer the advantage of squeezing and drinking or filling the fresh and natural fruit juice into the bottles and take it away. It is a stainless bottle stand required for places that provides self service to the customers.

Thanks to the stainless bottle stand, the customer can squeeze fresh juice into the bottle of any size and drink it safely.



Otomatik Portakal Sıkma Makineleri Teknik Özellikleri

Automatic Orange Juicer Machines Technical Specifications

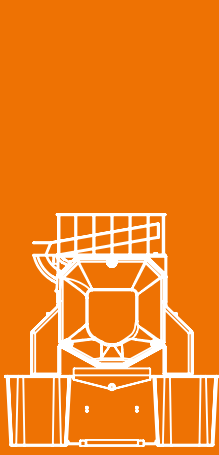

Cafe Tipi
Cafe Type

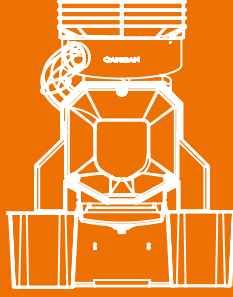

Bardaklı
With Glass

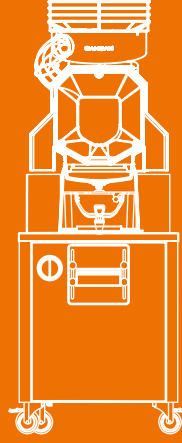

Depolu Arabalı
With Tank and Stand

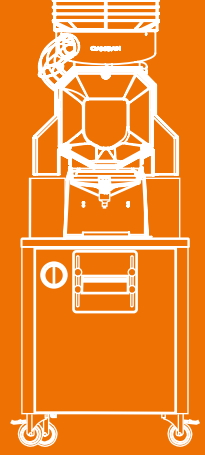

Fresh Arabalı
Fresh Model With Stand

Ürün Kodu
Product Code

0206

0203

0204 - 1101

0205 - 1101

Portakal Sıkma
Orange Squeezing

28 Adet / DK
28 Pcs / min.

38 Adet / DK
38 Pcs / min.

38 Adet / DK
38 Pcs / min.

38 Adet / DK
38 Pcs / min.

Portakal Çapı
Orange Diameter

Ø 6 - 8 cm.

Ø 6 - 8 cm.

Ø 6 - 8 cm.

Ø 6 - 8 cm.

Portakal Haznesi
Orange Basket

7 kg

15 kg

15 kg

15 kg

Motor
Motor

0,25 kw

0,37 kw

0,37 kw

0,37 kw

Tüketim
Consumption

2,5 A

2,5 A

2,5 A

2,5 A

Güç
Power

220 - 230 V

220 - 230 V

220 - 230 V

220 - 230 V

Frekans
Frequency

50 - 60 Hz

50 - 60 Hz

50 - 60 Hz

50 - 60 Hz

Ağırlık
Weight

55 kg

80 kg

115 kg

120 kg

Genişlik
Width

79 cm

79 cm

69 cm

69 cm

Derinlik
Depth

41 cm

58 cm

70 cm

70 cm

Yükseklik
Height

86 cm

98 cm

181 cm

181 cm

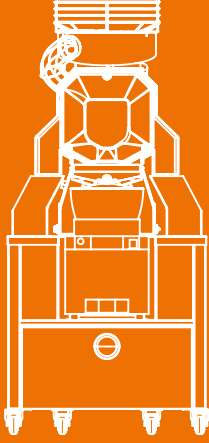

Soğutmalı
With Cooler

0208

38 Adet / DK
38 Pcs / min.

Ø 6 - 8 cm.

15 kg

0,37 kw

2,5 A

220 - 230 V

50 - 60 Hz

144 kg

82 cm

80 cm

181 cm

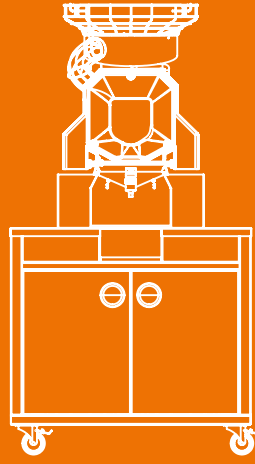

Çift Çöp Kovalı Arabalı Fresh
Fresh Model With Double Trash Can and Stand

0205 - 1107

38 Adet / DK
38 Pcs / min.

Ø 6 - 8 cm.

28 kg

0,37 kw

2,5 A

220 - 230 V

50 - 60 Hz

155 kg

106 cm

65 cm

199 cm

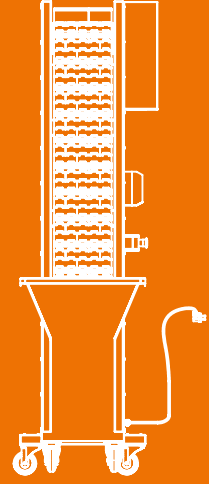

Yükleme Bunker
The Loading Buncer

0401

45 - 60 Adet / DK
45 - 60 Pcs / min.

Ø 6 - 8 cm.

40 - 60 kg

0,25 kw

2,5 A

220 - 230 V

50 - 60 Hz

95 kg

60 cm

94 cm

206 cm

Otomatik Nar&Greyfurt Sıkma Makinesi Genel Özellikleri 0601 - 0602

Automatic Pomegranate & Grapefruit Juicer Machine General Features

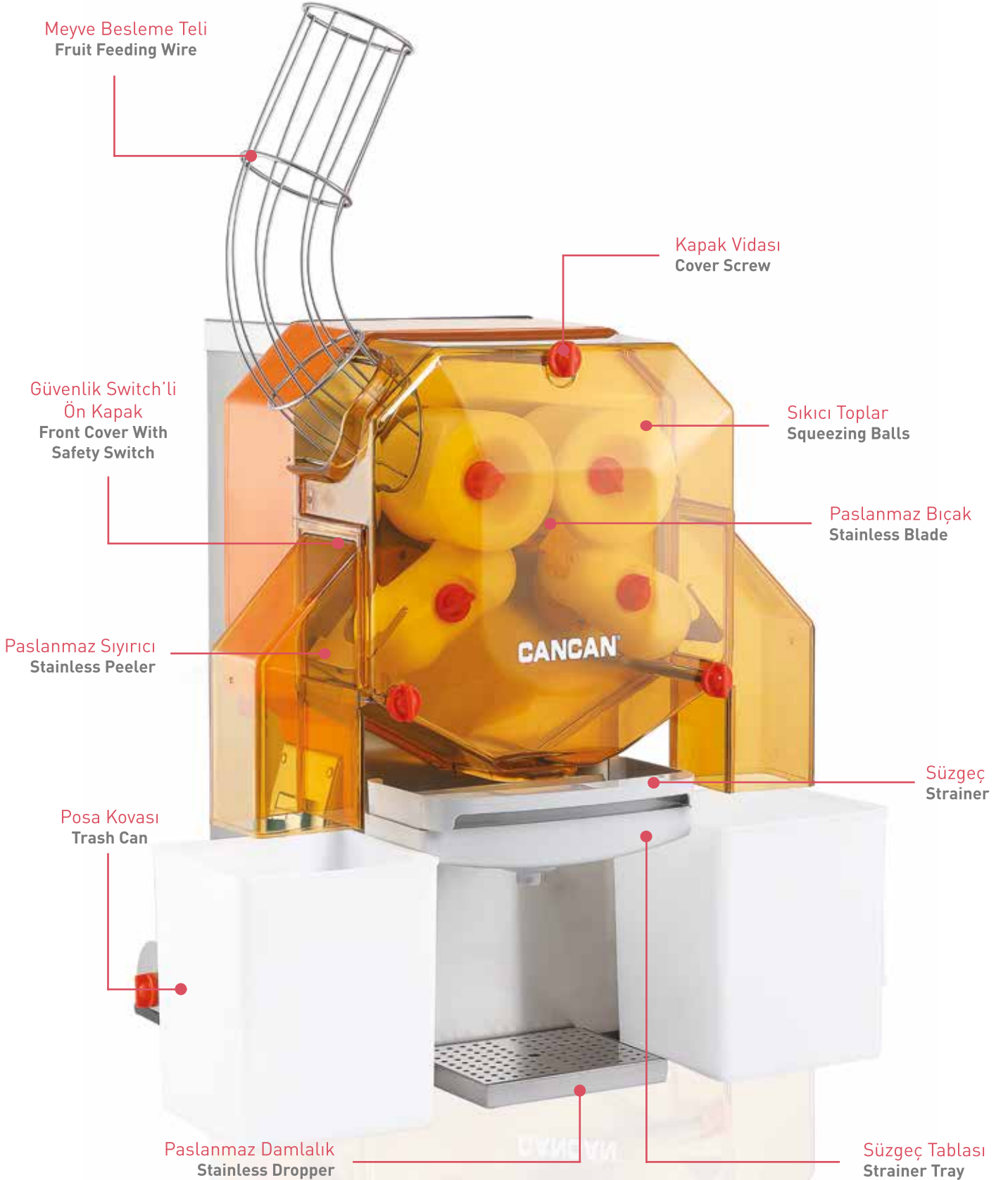

Otomatik Nar&Greyfurt Sıkma Makinesi Hakkında

About The Automatic Pomegranate & Grapefruit Juicer Machine

Otomatik Nar&Greyfurt sıkma makineleri; otel, restoran, okul, eğlence ve alışveriş merkezleri gibi mekânlarda nar ve greyfurt meyvelerinin sıkılması için tasarlanmıştır.

Tamamen otomatik olan ürün besleme, kesme, sıkma, posayı suyundan ayırma ve meyve suyunu depolama işlemlerini yapar. Dakikada 32 adet nar ve greyfurt sıkma kapasitesine sahip olan bu ürün hızlı, temiz ve kolay kullanım sağlar.

The Automatic Pomegranate & Grapefruit Juicer Machines are designed to squeeze pomegranate and grapefruits in places such as hotel, restaurant, school canteen, entertainment center and shopping malls.

This fully automatic machine; feeds, cuts and squeezes the pomegranates, removes the juice from the pulp and collects the juice. This product, capable of squeezing 32 pieces of pomegranates and grapefruits per minute, is fast and provides you clean and easy usage.

Yoğun Mekanlarda Üstün Depolama

Maximal Storage in Crowded Places

5 lt meyve suyu depolama kapasitesine sahip, gıda standartlarına uygun musluklu depo yoğun mekânlar için oldukça avantaj sağlar.

The juice tank with tap in accordance with food standards has a 5 liter capacity of juice and provides the user a big advantage for crowded places.

Paslanmaz Mobil Araba

Stainles Steel Mobile Stand

Depolu model mobil araba ile kullanılmaktadır. Mobil arabada 70 kg'lık posa biriktirme kapasitesine sahip posa kovası mevcuttur. Mobil arabadaki frenli tekerlekler sayesinde makineyi istediğiniz yere kolay bir şekilde taşıyabilirsiniz.

It is used together with the model that includes the juice tank. The Mobile stand includes a trash can with a 70 Kg capacity of fruit peels storage. With the braked wheels on the mobile stand, you can easily carry the machine anywhere you desire.



Otomatik Nar&Greyfurt Sıkma Detay Özellikleri

The Automatic Pomegranate Juicer Machine Detailed Features

Meyve Besleme Teli

Fruit Feeding Wire

Paslanmaz meyve besleme teli 6 ile 8 adet nar depolama imkanı sağlar.

The stainless fruit feeding wire provides to collect 6 to 8 pieces of pomegranates.



Sıkıcı Toplar

Squeezing Balls

Gıdaya uygun malzemeden üretilmiş sıkıcı toplar meyveyi kavrayarak tam verimli sıkılmasını sağlar. Bulaşık makinesinde yıkanabilir.

The squeezing balls made of material in accordance with the food standards, grasp the fruit and ensure efficient squeezing of the fruits. Dishwasher-Safe.



Paslanmaz Bıçak

Stainless Blade

Özel lazer kesim paslanmaz bıçak, 8 ile 10 cm çapındaki meyveleri ezmeden ikiye bölerek tam verimli sıkım sağlar. Bulaşık makinesinde yıkanabilir.

The special laser cut stainless blade, provides to squeeze the oranges efficiently of 8 to 10 cm diameters by cutting them in half without smashing. Dishwasher-Safe.



Paslanmaz Sıyırıcılar

Stainless Peelers

Paslanmaz çelik malzemeden üretilmiş sıyırıcılar, meyvelerin posalarını suyundan ayırarak posa kovalarına dökülmesini sağlar. Bulaşık makinesinde yıkanabilir.

The stainless steel peelers provide to separate the orange peel from the juice and make them fall into the trash cans. Dishwasher-Safe.



Süzgeç & Süzgeç Tablası

Strainer & Strainer Tray

Meyve posasını süzen, gıda standartlarına uygun süzgeç ve süzgeç tablasına sahiptir. Bulaşık makinesinde yıkanabilir.

It has a strainer and strainer tray in accordance with the food standards, that filters the fruit pulp. Dishwasher-Safe.



Otomatik Nar & Greyfurt Sıkma Makinesi Teknik Özellikleri

Automatic Pomegranate Juicer Machine Technical Specifications

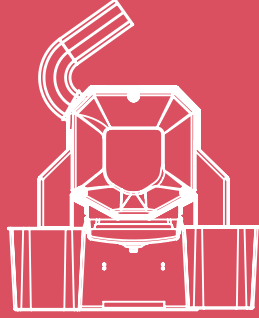

Bardaklı Model
With Glass Model

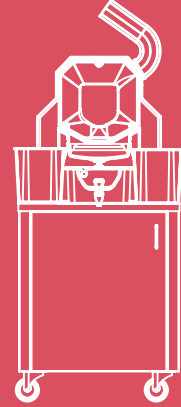

Depolu Arabalı Model
With Tank and Stand Model

Ürün Kodu
Product Code

0601

0602 - 1102

Meyve Sıkma
Fruit Squeezing

32 Adet / DK
32 Pcs / min.

32 Adet / DK
32 Pcs / min.

Meyve Çapı
Fruit Diameter

Ø 7 - 10 cm.

Ø 7 - 10 cm.

Meyve Haznesi
Fruit Reservoir

6 - 8 Adet
6-8 Pieces

6 - 8 Adet
6-8 Pieces

Motor
Motor

0,55 kw

0,55 kw

Tüketim
Consumption

2,5 A

2,5 A

Güç
Power

220 - 230 V

220 - 230 V

Frekans
Frequency

50 - 60 Hz

50 - 60 Hz

Ağırlık
Weight

60 kg

100 kg

Genişlik
Width

58 cm

78 cm

Derinlik
Depth

58 cm

72 cm

Yükseklik
Height

98 cm

198 cm

Hidrolik Nar Sıkma Presi Genel Özellikleri 0603



The Hydraulic Pomegranate Press General Features

Paslanmaz Meyve Haznesi
Stainless Fruit Reservoir

Uyarı Lambası
Warning Light

Başlatma Lambası
Start Light

Başlatma Butonu
Start Button

Pres Tablası
Press Tray

Süzgeç
Strainer

Güvenlik Switch'li Kapak
Cover With Safety Switch

Paslanmaz Damlalık
Stainless Dropper



2017 - 05054

Hidrolik Nar Sıkma Presi Üstün Özellikleri

The Hydraulic Pomegranate Press Superior Features

Hidrolik nar sıkma presi otel, restoran, ticari merkezler, eğlence ve alışveriş merkezleri, öğrenci yurtları, üniversiteler, meyve suyu büfeleri gibi mekânlar da kullanılabilir. Kompakt bir tasarıma sahip olan bu ürün dar çalışma alanlarında önemli avantaj sunar. Ek avantaj olarak geniş meyve çeşidini sadece tek bir makine ile sıkma imkânı sağlar.

Nar, portakal, greyfurt, limon, mandalina meyveleri hidrolik basınçlı sistem sayesinde çok rahatlıkla sıkar. Çift süzgeç sistemi sayesinde meyve posasını, meyve suyuna karıştırmaz. Komple paslanmaz gövdesi ve paslanmaz parçalarıyla temizliği çok pratik ve kolaydır.

The hydraulic pomegranate press is the smallest designed machine that can be used at places such as hotel, restaurant, commercial center, entertainment center, shopping mall, dormitory, university canteen and kiosks. With its compact design, this product offers significant advantages in narrow working areas. In addition it allows to squeeze a wide variety of fruits with just one machine.

Thanks to the hydraulic pressure system, the machine presses fruits such as pomegranate, orange, grapefruit, lemon, mandarin very easily. It is very practical and easy to clean with its stainless steel body and stainless parts.



8 Saniyede Sıkım

Squeezing in 8 Seconds

8 saniyede hızlı pres sistemi ile birçok narenciye meyvesini bir arada sıkmanın yanı sıra kolay ve seri sıkım gerçekleştirebilirsiniz.

Besides the convenience of squeezing many citrus fruits together with a fast press system as in 8 seconds it also provides the user an easy and fast squeezing process.



Karışık Sıkım

Mixed Squeezing

Geniş süzgeç tablası ile yeşil limon, nar, portakal, greyfurt, mandalina, limon gibi narenciye meyvelerini bir arada sıkabilir, kısa zaman içerisinde daha fazla meyve suyu elde edebilirsiniz.

You can squeeze the citrus fruits such as lime, pomegranate, orange, grapefruit, tangerine and lemon all together thanks to the large strainer table and you can get more juice in a short time.



Çift süzgeç ile daha az posa

Less Pulp With Double Strainer

Çift süzgeç özelliği ile daha az meyve posası geçirir, isteğe göre alt süzgeçini çıkartarak posalı meyve suyu elde edebilirsiniz. Ürün hidrolik sistemli olduğundan meyveyi firesiz sıkır ve çift süzgeç sayesinde posayı suya karıştırmaz. Sizin için tasarlanmış seçenekleriyle isteğe göre meyve suyunuzu ayarlayabilirsiniz.

Thanks to its double strainer feature it passes less fruit pulp and by removing the bottom strainer you can get pulpy fruit juice if wanted. Because of the hydraulic system of the product it presses the fruit without waste and thanks to its double strainer the pulp does not mix with the juice. You can arrange your own juice to your wish thanks to its options designed for you.

Güvenlik Switch'li Kapak

Cover With Safety Switch

Üründe bulunan güvenlik switch'leri sayesinde kapak açıkken makine çalışmaz ve herhangi bir iş kazasına neden olmadan güvenli bir şekilde sıkım yapar.

Thanks to the safety switches located on the product, the machine does not work when the cover is open and allows you to squeeze the fruit safely without causing any work accident.

Yedek Üst Süzgeç

Spare Upper Strainer

Ürün ile birlikte verilen yedek süzgecin sağladığı kolaylıkla, diğer süzgeci temizlemeyi beklemeden yedek süzgece meyveleri yerleştirip sıkıma hazır olarak bekletebilir ve daha hızlı sıkım sağlayabilirsiniz.

With the spare strainer provided with the product, you can easily place the fruits on the spare strainer without waiting for the other strainer to be cleaned and leave it ready for squeezing and provide faster squeezing process.

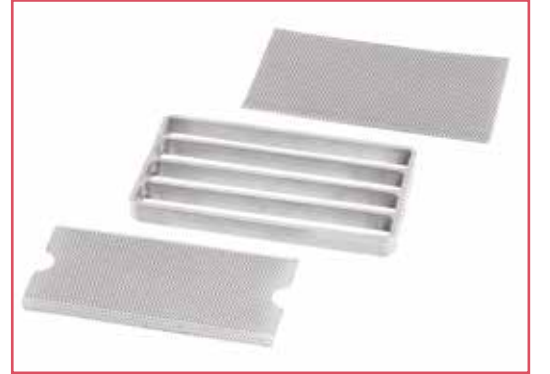

Hidrolik Nar Sıkma Makinesi Teknik Özellikleri

The Hydraulic Pomegranate Press Technical Specifications



Hidrolik Nar Sıkma Presi The Hydraulic Pomegranate Press

Ürün Kodu

Product Code

0603

Sıkma Tablası Ebatı

Pressing Plate Size

13 x 24 cm

Bardak Haznesi Yüksekliği

Cup Reservoir Height

17 cm

Meyve Sıkma

Fruit Squeezing

6 Adet / DK

6 Pcs / min.

Meyve Çapı

Fruit Diameter

Ø 13 cm.

Meyve Haznesi

Fruit Reservoir

7 kg

Motor

Motor

0,37 kw

Tüketim

Consumption

3,4 A

Güç

Power

220 V

Frekans

Frequency

50 - 60 Hz

Ağırlık

Weight

42 kg

Genişlik

Width

30 cm

Derinlik

Depth

42 cm

Yükseklik

Height

65 cm

0801

Ananas Soyma Makinesi Genel Özellikleri

Pineapple Peeler General Features

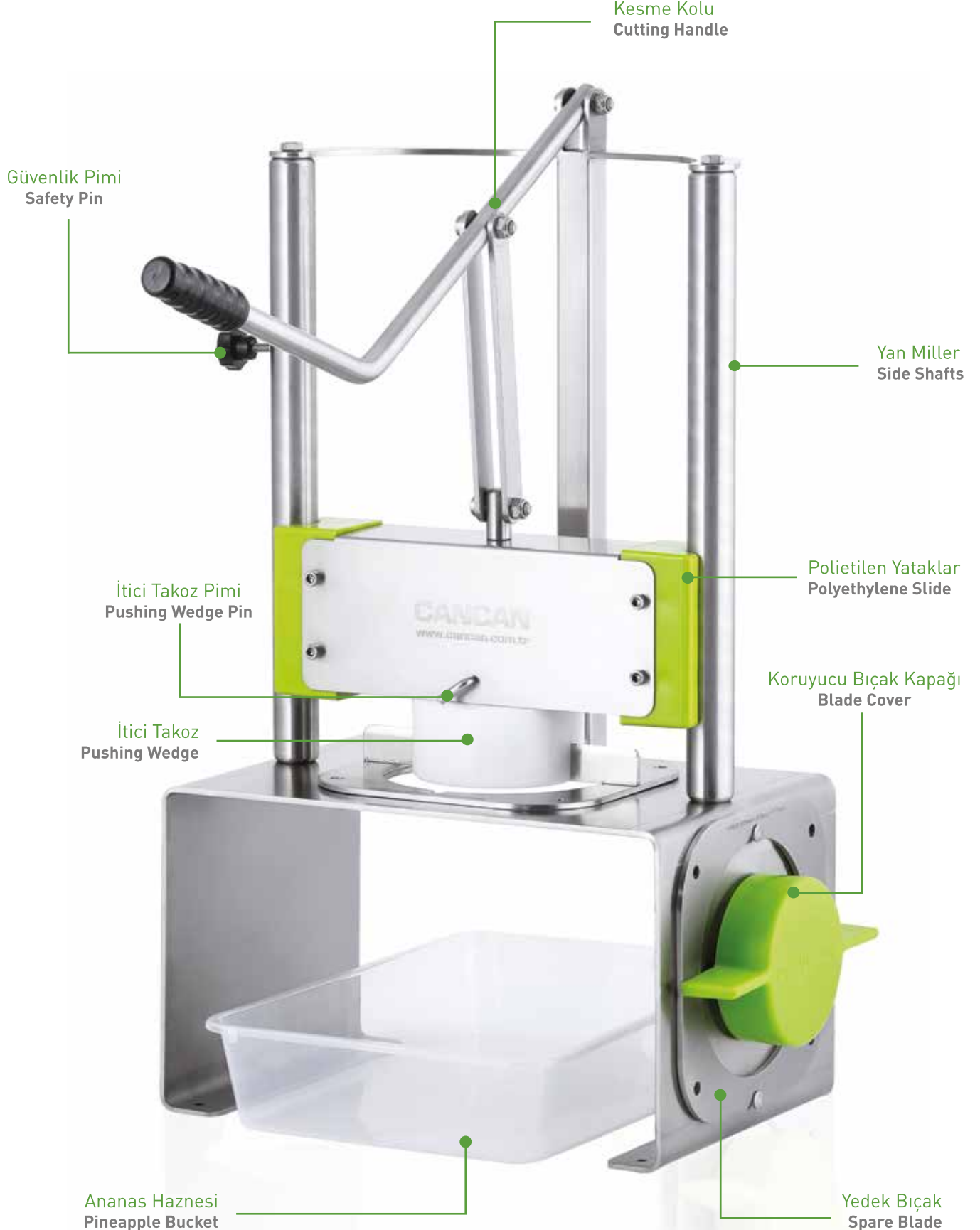

Ananas Soyma Makinesi Üstün Özellikleri

Pineapple Peeler Superior Features

Ananas soyma makineleri; otel, restoran, alışveriş merkezleri, market, manav reyonları gibi mekanlarda ananas meyvesinin fazla bir güç gerektirmeden tek bir hareketle kabuk ve çekirdeğini çıkarmak amacıyla dizayn edilmiştir.

Pineapple peeler is designed to remove shell and core from pineapple fruit with a single movement without requiring much power in places such as hotels, restaurants, shopping centers, supermarkets and grocery stores.



Polietilen Yataklar Polyethylene Slide

Polietilen malzemeden yapılmış olan yeşil kızakların özel tasarlanmış oval yapısı sayesinde ananas takılmadan, kolay bir şekilde kesilir.

Pineapple is easily cut with help of specially designed oval structure of polyethylene green slides.

Güvenlik Pimi Safety Pin

Ananas makinesinin sol kızağında bulunan güvenlik pimi ananas kesildikten sonra makinenin gövdesinin aşağıya düşmemesi için tasarlanmıştır. Kolay kullanıma sahip olan pim tek hamle ile ileri ittilererek gövdeyi yukarıda tutmaktadır.

Safety pin on the left side of the pineapple machine is designed to prevent the machine's body from falling down after peeling the pineapple. The easy-to-use pin keeps the body up by pushing forward with a single move.





İtici Takoz

Pushing Wedge

Ananas meyvesine üstten baskı yaparak ananasın kesilmesini sağlayan itici takoz, tamamen gıda standartlarına uygundur. Bıçakla uyumlu yapısı sayesinde ananasın fire vermeden kesilmesini sağlar. Kolay temizlenebilir.

The pushing wedge that cuts the pineapple by pressing the top of the pineapple fruit is totally suitable to food standards.

Thanks to the blade structure which is compatible with the knife, it ensures cutting without loss . It can be easily cleaned.

İtici Takoz Pimi

Pushing Wedge Pin

Beyaz itici takozun kolay bir şekilde makineden çıkartılıp temizlenmesi için tasarlanmış sistemdir.

It is a system designed to remove and clean the white pushing wedge easily from the machine.



Koruyucu Bıçak Kapağı

Blade Cover

Ananas soyma makinesinin üstünde bıçak asma aparatı mevcuttur. Böylece yedek bıçak yer kaplamaz.

Bıçaklarda güvenlik açısından kapak bulunmaktadır. Güvenlik kapakları oluşabilecek yaralanmaları engeller.

There is a blade hanging device on the pineapple peeling machine. Thus the spare blade does not occupy much space.

The blades have a cover for safety. Safety cover prevents possible injury.

Paslanmaz Bıçak

Stainless Steel Blade

Paslanmaz bıçak ananasların büyüklüğüne göre dört farklı çap'a sahiptir. Bu sayede bütün farklı boyutlardaki anaslara uyum sağlar. Gıdaya tamamen uygun olan bıçak, ortasında bulunan deliği sayesinde ananasın ortasındaki çekirdek kısmını da çıkarır.

Bıçak özel yapımıdır ve darbe haricinde körelme yapmaz. Üründe iki adet farklı boyutta bıçak mevcuttur.

The stainless blade has four different diameters depending on the size of the pineapples. Thus, it adapts to all different sizes of pineapples.

The blade is specially made and does not blunt except for impact. There are two different size blades in the body.



Yedek Bıçaklar

Spare Blades

Ananasın boyutlarına göre değişen 4 farklı bıçak boyutu mevcuttur.

Bıçaklarda güvenlik açısından kapak bulunmaktadır. Güvenlik kapakları oluşabilecek yaralanmaları engellemiş olur.

There are 4 different blade sizes depending on the size of the pineapple.

The blades have a cover for safety. The safety cover prevents possible injury.

Ananas Çaplarına Uygun Bıçak Seçenekleri

Blade Options According to Pineapple Diameters



Paslanmaz Stand Stainless Steel Stand

Raflı ve rafsız iki seçeneği bulunan paslanmaz stand, ananas meyvelerinin saklanması için tasarlanmıştır. Standın altında bulunan plastik tabanları sayesinde zeminde kayma yapmaz.

The stainless stand that has two options, with and without shelves, is designed for storage of the pineapples. It does not slip on the floor due to the plastic bases that is located under the stand.



Yumuşak Hatlar Soft Lines

Ananas makinesinin kenar kısımları herhangi bir darbeye yaranma olmaması amacıyla yumuşak geçişli yapılmıştır. Bu sayede iş kazaları minimuma indirilmiştir.

The edges of the pineapple machine are made with a smooth transition to avoid any injuries. In this way, work accidents are minimized.

Ananas Soyma Makinesi

Teknik Özellikleri & Bıçak Ölçüleri

Pineapple Peeler Machine Technical Specifications & Blade Sizes

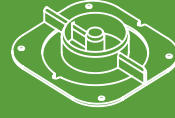
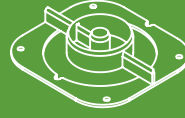

Ürün Kodu

Product Code

0800.01

0800.02

0800.03

0800.04

Bıçak Çapı / Blade Diameter

Ø 74 mm.

Ø 89 mm.

Ø 95 mm.

Ø 102 mm

Çekirdek Çapı / Core Diameter

Ø 25 mm

Ø 25 mm

Ø 25 mm

Ø 25 mm

Maksimum Ürün Çapı / Max Product Diameter

Ø 150 mm.

Ø 150 mm.

Ø 150 mm.

Ø 150 mm

Ananas Adet - Kutu / Pineapple Pieces-Box

10'lu

10 Pcs

8'li ve 9'lu

8-9 Pcs

7'li

7 Pcs

6' lı

6 Pcs

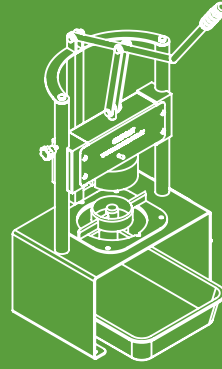

Ananas Soyma Makinesi

Pineapple Peeler Machine



Ananas Standı

Pineapple Peeler Stand

Ürün Kodu

Product Code

0801

1103

Ağırlık / Weight

12,75 kg

19 kg

Derinlik / Depth

55 cm

65 cm

Genişlik / Width

37 cm

41,5 cm

Yükseklik (Kol Düşük) / Height (Arm Down)

65 cm

82,5 cm

Yükseklik (Kol Yüksek) / Height (Arm Up)

115 cm

131,5 cm

0702 - 0703 Profesyonel Tip Elektrikli Konserve Açma Makinesi Genel Özellikleri

Professional Type Electrical Can Opener General Features

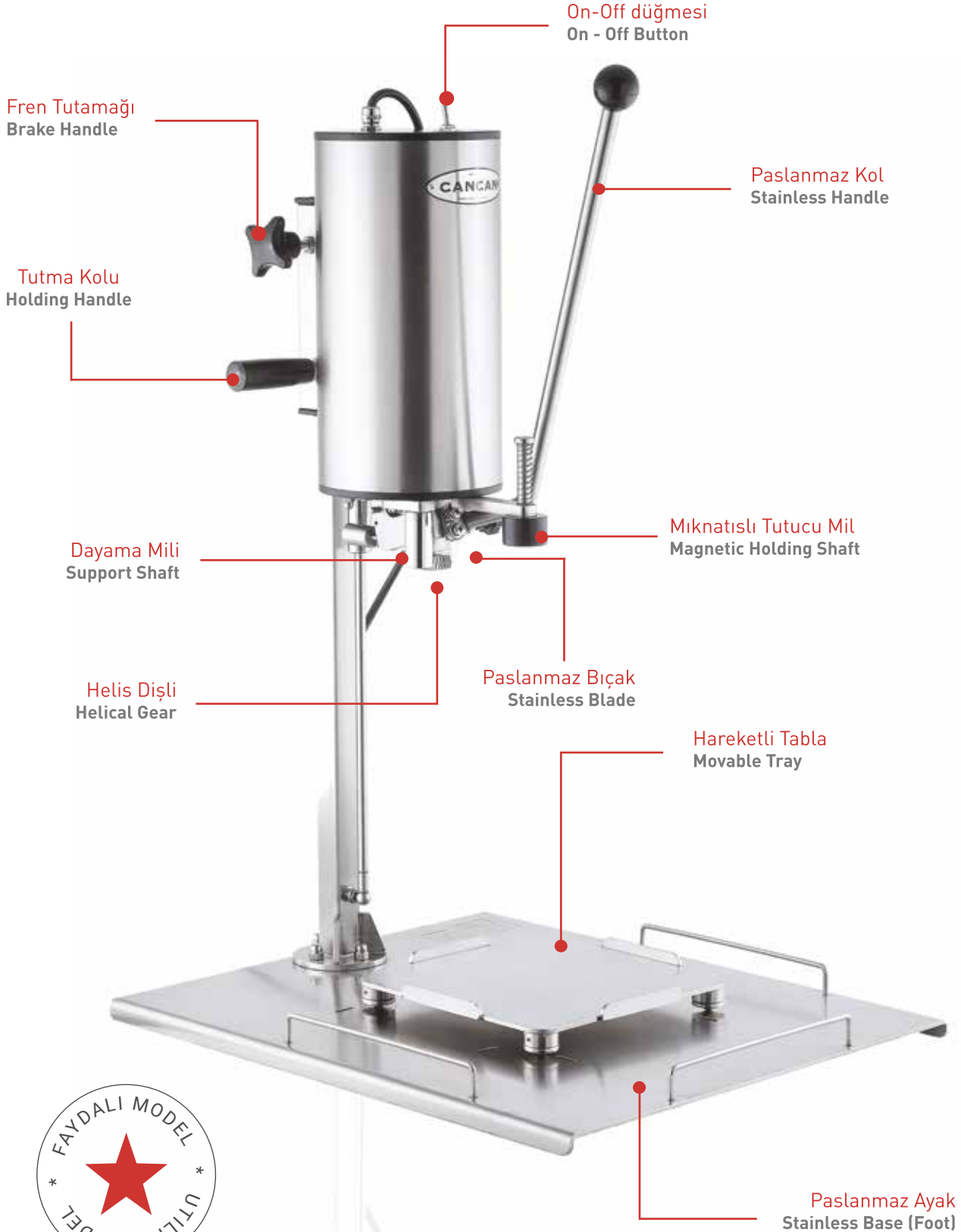

2012 - 04594

Profesyonel Tip Elektrikli Konserve Açma Makinesi Üstün Özellikleri

Professional Type Electrical Can Opener Superior Features

Tamamen paslanmaz profesyonel tip elektrikli konserve açma makinesi; sıyırma ve kaçırmaı önleyici dönen helis dişli ve özel tasarım paslanmaz bıçak yardımıyla endüstriyel mutfaklardaki peynir, zeytin, konserve boya gibi konserve tenekelerinin fazla güç gerektirmeden kısa sürede, hızlı bir şekilde açılması için tasarlanmıştır. Profesyonel tip elektrikli konserve açma makinesi; oluşabilecek iş kazalarının önüne geçerek firmaların iş güvenliği sağlamasına destek olmuştur.

The all stainless steel professional type electric can opener is designed to open tin cans such as cheese, olive, paint cans etc. in industrial kitchens without the need of extra power in a short time and in a quickly way with the help of the rotating helical gear that prevents gliding and slipping and the special design cutting blade. Professional type electric can opener prevents possible workplace accidents.



Tutma Kolu Holding Handle

Ürünü yukarıya ve aşağıya rahatlıkla hareket ettirebilmeniz için tasarlanmıştır.

It is designed to move the product up and down easily.

Fren Tutamağı Brake Handle

Ürün gövdesini istenilen yükseklikte sabitlemek için tasarlanmıştır.

Designed to secure the product body at the desired height.



Helis Dişli Helical Gear

Özel imalat sertleştirilmiş helis dişli sıyırma ve kaçırmaı önleyerek uzun ömürlü ve dayanıklı bir kullanım sağlar.

The special manufacturing stainless blade provides clean cutting by removing rough edges and metal chips. It is long lasting and durable.

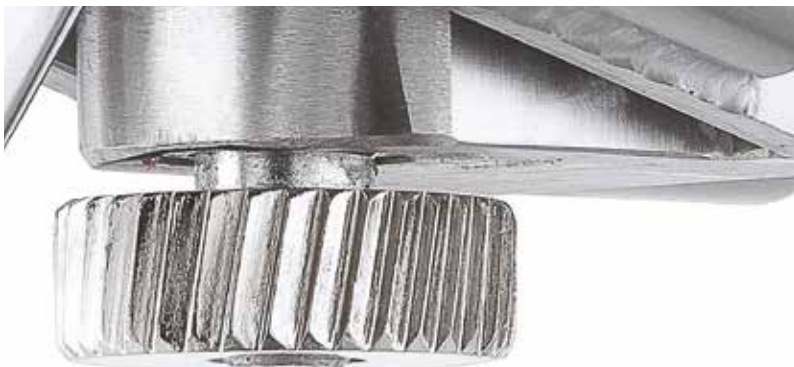



Paslanmaz Bıçak

Stainless Blade

Özel imalat paslanmaz bıçak pürüzlü kenarları ve metal talaşını gidererek temiz kesim sağlar. Uzun ömürlü ve dayanıklı olmakla birlikte körelme yapmaz.

Special manufacturing stainless knife provides clean cutting by removing rough edges and metal shavings. Besides the features of being long lasting and durable it doesn't blunt.



Paslanmaz Kol

Stainless Handle

Paslanmaz kolu aşağıya indirdiğinizde bıçak konserveye tam sabitlenir ve makineyi çalıştırdığınızda konserveyi açar.

When you lower the stainless handle, the blade is fully fixed to the can and it will open cans when you start the machine.



Paslanmaz Dayama Mili

Stainless Support Shaft

Konserve tenekesinin makineye tam oturmasını sağlamak için tasarlanmıştır.

It is designed to ensure that cans will fixed fully to the machine.

Paslanmaz Ayak

Stainless Base (Foot)

Hareketli ve döner tablanın üzerine konduğu paslanmaz ayak, hem görünüş hem güvenlik bakımından yumuşak hatlara sahiptir.

The Stainless Base (Foot) that has the turntable / moving table located on, has soft lines for both appearance and safety.





Kol Vidası Handle Screw

Paslanmaz kol ve bıçağın, rahat bir şekilde çıkarılıp kolaylıkla temizlenebilmesi amacıyla tasarlanmıştır.

Designed to remove and clean stainless handle and blade easily.

Mıknatıslı Tutucu Mil Magnetic Holding Shaft

Kuvvetli mıknatısa sahip tutucu mil kesim sonrası kapağı tutarak gıdanın içine düşmesini engeller.

The holding shaft with a strong magnet holds the cover and prevents the falling down of the cover into the food can, after the cutting.



Hareketli Tabla Moving Tray

Kare tenekeler için tasarlanmış paslanmaz tabladır. Tabla ayaklarının altında bulunan misket tekerlekler sayesinde kare tenekeler açım esnasında rahatlıkla hareket ettirilebilir.

The Stainless steel tray is designed for square cans. Square food cans can be easily moved during the opening process thanks to the wheel caster under the tray legs.



Döner Tabla Turntable Tray

Dairesel konserveleri açım sırasında 360 derece döndürerek rahat bir şekilde açılması için tasarlanmıştır.

It is designed to open the circular cans easily by rotating them 360 degrees.



0701 Elektrikli Konserve Açma Makinesi Genel Özellikleri

Electrical Can Opener General Features

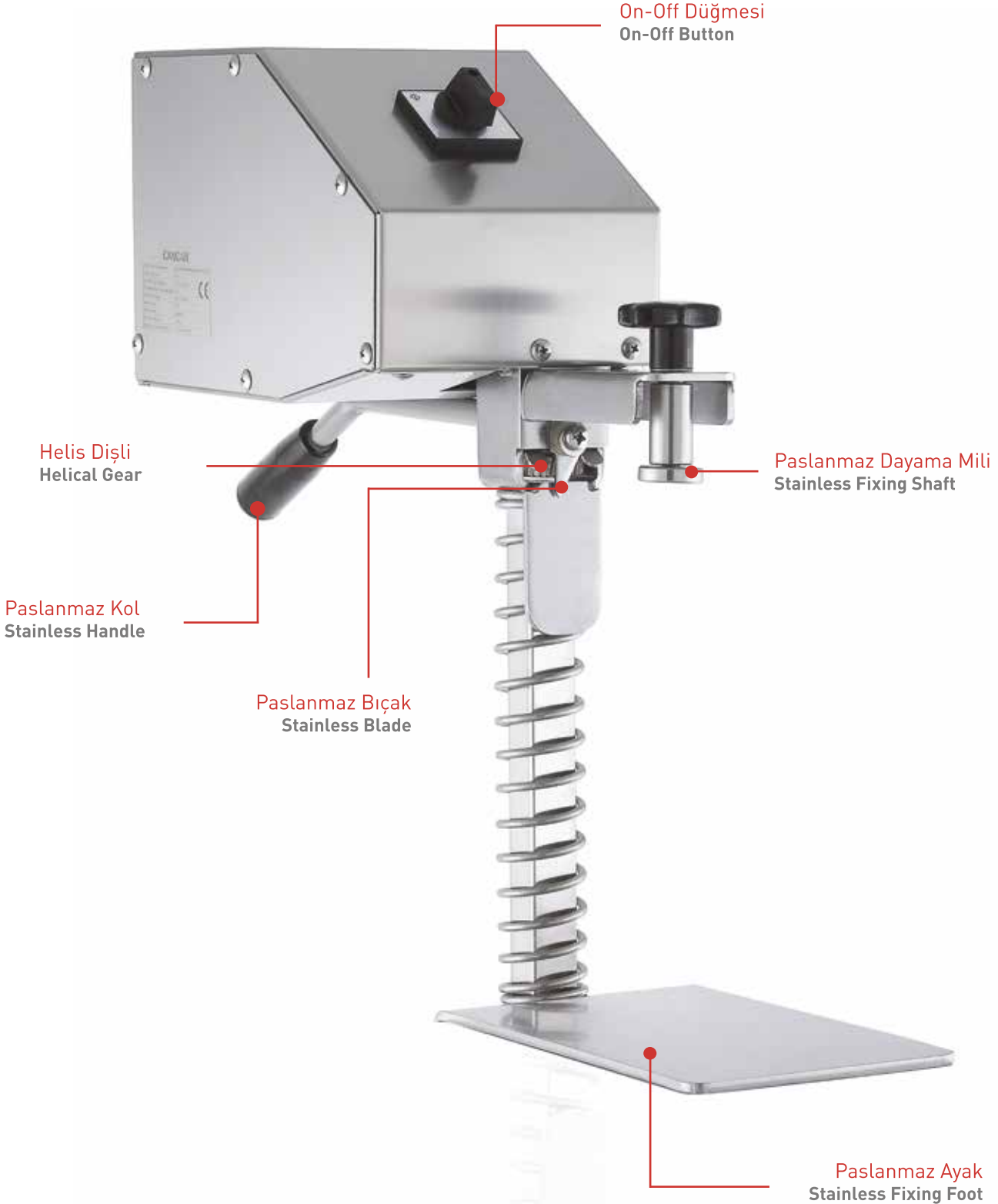

Elektrikli Konserve Açma Makinesi Üstün Özellikleri

Electrical Can Opener Superior Features

Tamamen paslanmaz elektrikli konserve açma makinesi; sıyırma ve kaçırmayı önleyici, redüktör tahrikli dönen helis dişli ve özel tasarım paslanmaz bıçak yardımıyla endüstriyel mutfaklarda 0,25 kg ile 5 kg arasındaki dairesel konserve tenekelerinin hızlı bir şekilde açılması için tasarlanmıştır.

Fully stainless electrical can opener is designed for quick opening of circle cans (0,25kgs-5kgs) in industrial kitchens with help of special design blade and rotating, reductor supported helical gear which prevents abrasion and slip.



Helis Dişli Helical Gear

Özel imalat sertleştirilmiş helis dişli sıyırma ve kaçırmayı önleyerek uzun ömürlü ve dayanıklı bir kullanım sağlar.

The special manufacturing stainless blade provides clean cutting by removing rough edges and metal chips. It is long lasting and durable.

Paslanmaz Bıçak Stainless Blade

Özel imalat paslanmaz bıçak pürüzlü kenarları ve metal talaşını gidererek temiz kesim sağlar. Uzun ömürlü ve dayanıklıdır.

Special manufacturing stainless knife provides clean cut by removing rough edges and metal shavings. Long lasting and durable.



Paslanmaz Sabitleme Mili Stainless Fixing Shaft

Konserve açacağı zemine oturduktan sonra sabitleme mili ile masaya kolaylıkla sabitlenir ve bu sayede konserveyi açarken ayak oynamaz.

After can opener is placed on the counter, the fixing table is easily mounted to the counter so that the fixing table does not move during opening process.



Paslanmaz Dayama Mili

Stainless Fixing Shaft

Konserve tenekesinin makineye tam oturmasını sağlamak için tasarlanmıştır.

It is designed to ensure that cans will fixed fully to the machine.

Paslanmaz Kol

Stainless Handle

Paslanmaz kolu aşağıya indirdiğinizde makine çalışmaya başlayarak konserveyi açar.

When you lower the stainless handle the machine will start to work and open the can.



Sabitlenme Ayağı

Stainless Fixing Foot

Ayarlanabilir paslanmaz sabitleme ayağı kolay monte edilebilir.

The adjustable stainless fixing foot can assembled easily.



Elektrikli Konserve Açma Makineleri Teknik Özellikleri

Electrical Can Openers Technical Specifications

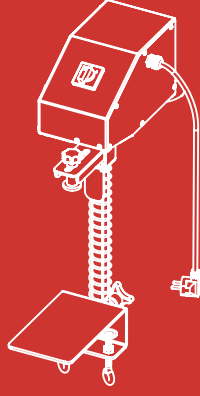

Elektrikli Model
Electrical Model

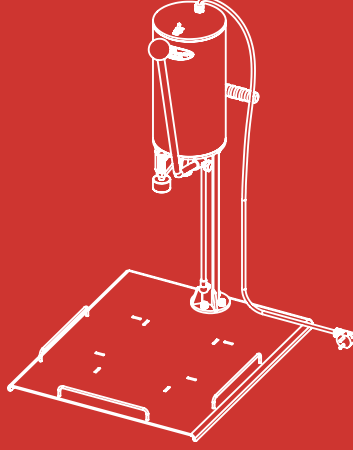

Dairesel Model
Circle Cut

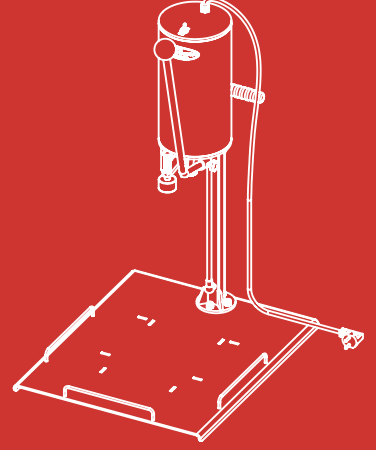

Dairesel - Kare Model
Circle - Square Cut

Ürün Kodu
Product Code

0701

0702

0703

Kesim Türü
Cutting Type

Dairesel
Circle

Dairesel
Circle

Dairesel - Kare
Circle - Square

Konserve

Kesim Kapasitesi
Can Opening Capacity

3-8 Adet Dakikada
3-8 Pieces Per Min

3-8 Adet Dakikada
3-8 Pieces Per Min

3-8 Adet Dakikada
3-8 Pieces Per Min

Konserve Ebatları
Can Size

50 - 300 mm
Yükseklik Arası Dairesel
Height Interval Circle

60 - 240 mm
Yükseklik Arası Dairesel
Height Interval Circle

120 - 345 mm
Yükseklik Arası Dairesel
Height Interval Circle

130 - 350 mm
Yükseklik Arası Kare
Height Interval Square

Güç - Frekans

Power - Frequency

220 / 230 Volt - 50 / 60 Hz

220 / 230 Volt - 50 / 60 Hz

220 / 230 Volt - 50 / 60 Hz

Motor / Engine

0,18 kW

0,18 kW

0,18 kW

Ağırlık / Weight

14 kg

30 kg

36 kg

Derinlik / Depth

50 cm

31 cm

59 cm

Genişlik / Width

15 cm

50 cm

49 cm

Yükseklik / Height

60 cm

80 cm

90 cm

Manuel Konserve Açacakları Teknik Özellikleri

Manuel Can Openers Technical Specifications



Profesyonel Model
Professional Type



Diamond Model
Diamond Type

Ürün Kodu
Product Code

0302

0303

Ağırlık / Weight

2 kg

3 kg

Profil Boyutu / Profile Height

63 cm

63 cm

Günlük Kapasite
Daily Capacity

40 - 65 konserve
40 - 65 cans

65 - 100 konserve
65 - 100 cans

Güvenli ve Hijyenik
Safety and Hygienic



0302
Profesyonel Model
Professional Type



0303
Diamond Model
Diamond Type

Manuel Konserve Açacakları
Manual Can Openers

Profesyonel Model Konserve Açma Makinesi Özellikleri

Professional Model Can Opener General Features



Bıçak Taşıyıcı Blade Carrier

Tek bir hamleyle sökülüp takılabilen alüminyum bıçak taşıyıcı kolay temizleme ve değiştirme avantajı sağlamaktadır.
Aluminum blade carrier can be removed and mounted with a single move, and provides advantage of easy cleaning and replacement.

Plastik Kol
Plastic Handle

Helis Dişli
Helical Gear

Paslanmaz Profil
Stainless Profile

Paslanmaz Ayak
Stainless Foot

Sabitleme Mili
Fixing Spindle



Çevirme Kolu Plastic Handle

Plastik çevirme kolu ergonomik yapısıyla konserve kutusunun minimum kuvvet harcayarak açılmasını sağlamaktadır.
With its ergonomic structure, the plastic handle ensures that cans are opened with minimum force.

Diamond Model Konserve Açma Makinesi Özellikleri

Diamond Model Can Opener General Features



Bıçak Taşıyıcı Blade Carrier

Tek bir hamleyle sökülüp takılabilen paslanmaz bıçak taşıyıcı kolay temizleme ve değiştirme avantajı sağlamaktadır.

Blade carrier can be removed and mounted with a single move, and provides advantage of easy cleaning and replacement.

Paslanmaz Køl
Stainless Handle

Helis Dişli
Helical Gear

Paslanmaz Profil
Stainless Profile

Paslanmaz Ayak
Stainless Foot

Sabitleme Mili
Fixing Spindle



Çevirme Kolu Stainless Handle

Paslanmaz çevirme kolu ergonomik yapıyla konserve kutusunun minimum kuvvet harcayarak açılmasını sağlamaktadır.

With its ergonomic structure, the stainless handle ensures that cans are opened with minimum force.

Manuel Konserve Açma Makineleri Ortak Özellikleri

Manual Can Openers Common Features

Manuel konserve açacakları; profesyonel catering, endüstriyel mutfaklar, hastaneler, bakım evleri, kantinler gibi mekanlarda güvenli ve hijyenik bir şekilde büyük veya küçük konserve ayırmaksızın kullanıcılara büyük kolaylık sağlamaktadır.

The manual can openers are providing big convenience to the users by opening either small or big cans in a safe and hygienic way in the Professional catering sector and places such as industrial kitchens, hospitals, nursing homes and school canteens.

Helis Dişli

Helical Gear

Özel imalat sertleştirilmiş helis dişli sıyrma ve kaçırma önleyerek uzun ömürlü ve dayanıklı bir kullanım sağlar.

Special manufacturing hardened helical gear prevents stripping and slipping and provides long lasting and durable use.



Paslanmaz Bıçak

Stainless Blade

Özel imalat paslanmaz bıçak pürüzlü kenarları ve metal talaşını gidererek temiz kesim sağlar. Uzun ömürlü ve dayanıklıdır.

The special manufacturing stainless blade provides clean cutting by removing rough edges and metal chips.

Paslanmaz Profil

Stainless Profile

Ayarlanabilir çalışma aralığı sağlayan paslanmaz profil 55 cm yüksekliğe kadar bütün konserveleri açabilir.

The stainless profile, which provides adjustable working range, can open all cans up to a height of 55 cm.



Paslanmaz Sabitleme Mili

Stainless Fixing Spindle

Konserve açacağı zemine oturduktan sonra sabitleme mili ile masaya kolaylıkla sabitlenir ve bu sayede konserveyi açarken ayak oynamaz.

After the can opener is seated on the table, it is easily fixed to the table with the fixing spindle so that the foot doesn't move during the opening process.



CANCAN[®]
Ön Yıkama Duşları
Pre - Rinse Faucets

Ön Yıkama Duşları

Pre-Rinse Faucets



Ön yıkama duşları, endüstriyel mutfaklarda, sanayi tipi bulaşık yıkama makinelerinde, sebze ve meyve yıkama ünitelerinde ön yıkama aşamasında kullanılmaktadır.

Pre-rinse faucets are used in industrial kitchens, industrial dishwashing machines, vegetable and fruit washing units in the pre-washing stage.



MT01
Tezgaha Monte
MT01 Sink Mounted

MT02
Tezgaha Monte Ara Musluklu
Sink Mounted With Intermediate Tap

MT03
Duvara Monte
Wall Mounted

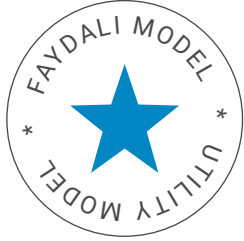

2014 - 06257



Hortum
Hose

Ara Batarya
Intermediate Tap



MT04

Duvara Monte Ara Musluklu
Wall Mounted With Intermediate Tap

MT05

Mini Boy Eviye Tipi
Mini Size Sink Type

MT06

Mini Boy Eviye Tipi Ara Musluklu
Mini Size Sink Type With Intermediate Tap

Ön Yıkama Duşları Ortak Özellikleri

Pre-Rinse Faucets Common Features

Hortum ve Koruyucu Spiral Yay

Hose and Protective Spiral Spring

EPDM kauçuk malzemeden yapılmış olan hortum, flexible paslanmaz örgülü ve üzeri PVC kaplamadır. Spiral örgülü hortum 100 derece sıcaklığa kadar dayanıklıdır.

Lak kaplamalı yay sistemi, hortumun kırılmasını ve bükülmesini önler. Yayın ucunda hortumu koruyucu plastikler mevcuttur.

The hose, made of EPDM rubber, is flexible stainless steel braided and PVC coated. The spiral braided hose is resistant to 100 degree temperature.

The lacquered coated spring system prevents the hose from breaking and twisting. There are hose protective plastics at the end of the spring.



Batarya

The Faucet

Eviye tipi ve duvar tipi olarak iki çeşit batarya mevcuttur. Batarya parçaları pirinç üzeri krom kaplamadır.

There are two types of faucets; sink type and wall type. The parts of the faucets are made of brass coated with chrome.



Elcik

Spray Pistol

Basınçlı su çıkışı sağlayan elcik, kendi etrafında 360 derece dönebilir ve bu sayede rahat kullanım sağlar. Su sarfiyatını önleyen özel tasarım su çıkış süzgecine sahiptir.

The spray pistol that provides pressurized water outlet can rotate 360 degrees around itself and thus provides comfortable use. It has a special design water outlet filter which prevents water consumption.



Geritoplamalı Ön Yıkama Duşları

Retractable Pre-Rinse Faucets With Reel Hose



Geritoplamalı ön yıkama duşları, endüstriyel mutfaklarda, gıda hazırlık ve toplu yemek üretim tesislerinde, sanayi tipi bulaşık yıkama makinelerinde, sebze ve meyve yıkama eviyelerinde 2 kademeli toplanabilir hortumu ile minimum 100m²'lik alanda ön yıkama duşu olarak kullanılmaktadır.

Retractable pre-rinse faucets with reel hoses are used in industrial kitchens, food preparation and mass food production facilities, industrial dishwashing machines, vegetable and fruit washing units, at the pre-washing stage in a minimum 100 squaremeters area with 2 stage collectible hose.



Gerçek Toplamalı Ön Yıkama Modelleri

Retractable Pre-Rinse Faucets With Reel Hose Models



0906

2 Metre Gerçek Toplamalı

2 Meters Retractable



0901

6 Metre Gerçek Toplamalı

6 Meters Retractable



0902 - 0904

10 - 15 Metre Gerçek Toplamalı

10 - 15 Meters Retractable

Genel Özellikleri

General Features

16 mm kalınlıkta, 2 m - 6 m - 10 m - 12 m - 15 m uzunlukta hortum sarma kapasitesi.

2 m uzunluğunda hortuma sahip fırın için kullanılmak üzere tasarlanmış fırın tipi gerçekt toplamalı ön yıkama duşu.

Duvara monte edilebilen 180°C dönebilen kasa.

Ayarlanabilir hortum çıkış özelliği.

Polyamid yataklı makara göbeği.

2 kademeli kilitleme özelliği.

%100 paslanmaz dış gövde ile hijyen standartlarına uygunluk.

30-50 bar çalışma basıncına dayanıklı özel üretim hortum.

Hose Spiral capacity of 16 mm thickness and 6m-10m-12m-15m length.

Oven type retractable pre-rinse faucet with reel hose designed to use for ovens with a 2 meters length hose.

180 degree rotatable, wall mountable case.

Adjustable hose output feature.

Polyamide-bearing Pulley Hub.

2-stage lockable feature.

Compliance with hygiene standards with 100% stainless body.

30-50 bar working pressure resistant special production hose.



Ön Yıkama Duşlar Teknik Özellikleri

Pre-Rinse Faucets Technical Specifications

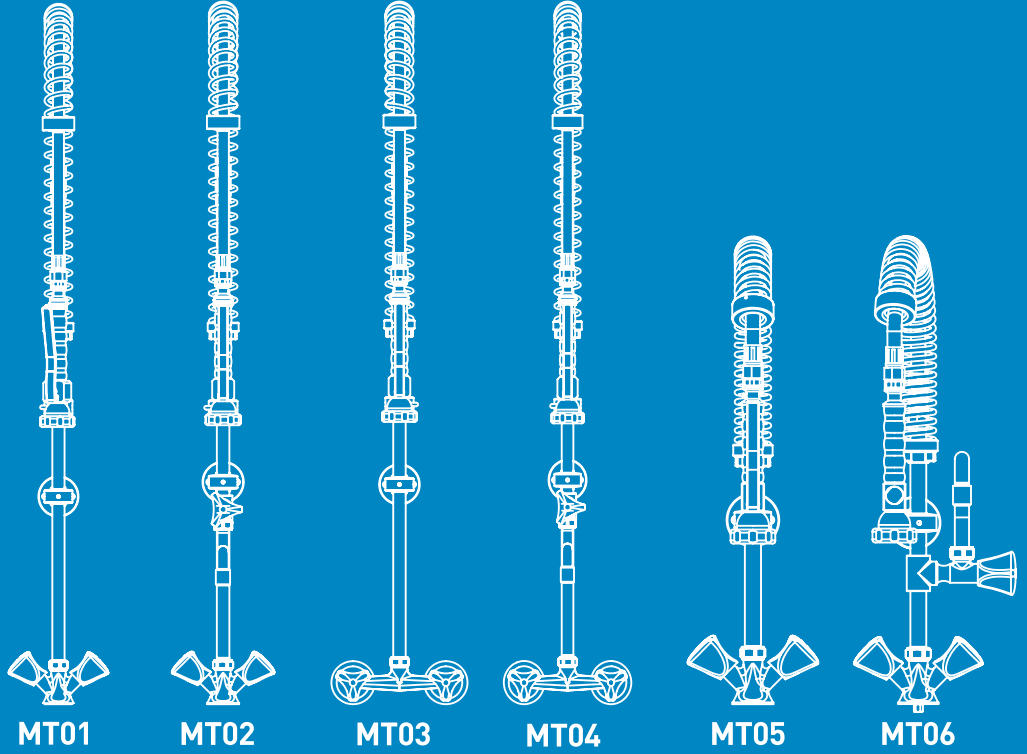

Ürün Kodu
Product Code

0501

0502

0503

0504

0505

0506

Ağırlık / Weight

3 kg

4,8 kg

3 kg

4,8 kg

3 kg

3,5 kg

Genişlik / Width

15 cm

15 cm

15 cm

15 cm

15 cm

20 cm

Derinlik / Depth

44 cm

44 cm

44 cm

44 cm

25 cm

25 cm

Yükseklik / Height

120 cm

120 cm

120 cm

120 cm

58 cm

58 cm

Gerçek Toplamalı Ön Yıkama Duşları Teknik Özellikleri

Retractable Pre-Rinse Faucets With Reel Hose Technical Specifications

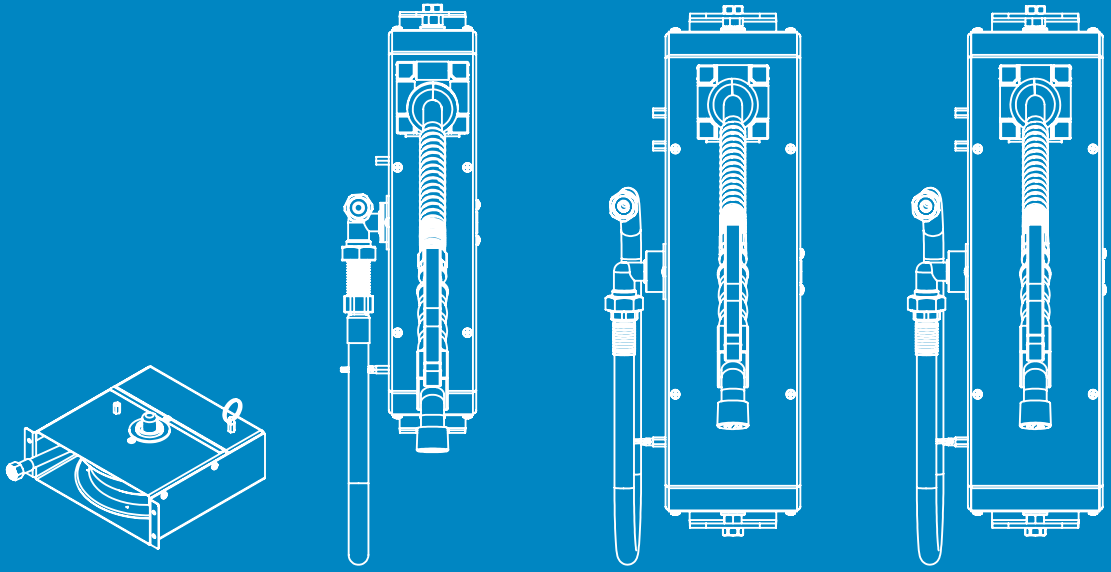

GT02

GT06

GT10

GT15

Ürün Kodu

Product Code

0906

0901

0902

0904

Ağırlık / Weight

3 kg

9 kg

13,5 kg

17,5 kg

Genişlik / Width

10 cm

8 cm

12 cm

12 cm

Derinlik / Depth

20 cm

42 cm

49 cm

49 cm

Yükseklik / Height

23 cm

38 cm

45 cm

45 cm



Endüstriyel Tip Kazan Yıkama Makinesi

Industrial Type Pot Washing Machine

Kazan yıkama makinesi, dönen bir fırça veya parlatma fırçası yoluyla endüstriyel mutfaklardaki tencere, tava ve kazanlara yapışan kirleri ve yağları fazla güç gerektirmeden kısa sürede, hızlı bir şekilde temizlenmesi için dizayn edilmiştir. Bu sistem kazan yıkama eviyelerinin üzerine monte edilerek kullanılabilceği gibi istenirse mutfak içinde hareket edebilen tekerlekli özel arabası ile mutfağın içinde her yerde mobil temizlik fırçası olarak da kullanılabilir. Sabit olarak kullanıldığında makine gövdesi yerden 1.15m yüksekliğe monte edilmelidir.

Kazan yıkama makinesinde 2 adet farklı fırça bulunmaktadır. Birincisi yıkama fırçası diğeri parlatma fırçasıdır. Yıkama fırçası ile kazan ve tencerelerdeki kirleri yüksek ısılı sıcak su ile el değmeden ve güç harcamadan kolayca temizleme imkânı sağlamaktadır. Diğer fırça ile tencerelerinizde meydana gelen kararma ve kazan diplerindeki taban yanıklarının kolayca parlatılma işlemi yapılmaktadır.

Kazan yıkama makinesinin motor kısmı yağ basıncı ile çalıştığından su içinde çalışan kullanıcıyı elektrik çarpması gibi tehlikelerden uzak tutar. Kazan yıkama makinesi endüstriyel mutfakların kaçınılmaz bir ihtiyacıdır.



The pot washing machine is designed to clean the dirt and grease sticking to pots, pans and boilers in a short time, without requiring extra power in industrial kitchens with the help of the rotating brush or the polishing brush. This system can be used by mounted on washing sinks or can be used as a mobile cleaning brush everywhere in the kitchen with a trolley (optional) that can move in the kitchen. While it is used immobile, the body of the machine should be mounted at the height of 1,15 m.

There are two different brushes with the pot washing machine. The washing (rotating) brush and the polishing brush. With the help of the washing brush it provides the user to clean the boiler and pots very easily with high-temperature water without touching hands and without using extra power. With the polishing brush you can remove all the dark spots and burnish at the cookware.

Since the engine part of the Pot Washing Machine works with oil pressure, it keeps the user who is working in water, away from danger such as electric shock. The Pot Washing Machine is an essential need for industrial kitchens.

Endüstriyel Tip Kazan Yıkama Makinesi

Teknik Özellikleri

Industrial Type Pot Washing Machine Technical Specifications

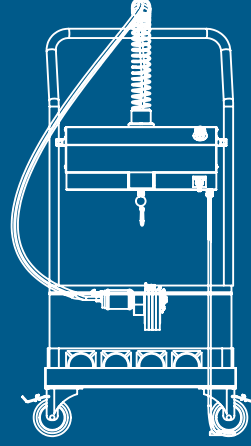

Ürün Kodu / Product Code

1001

Motor / Motor

0,37 kW

Motor Voltajı / Motor Voltage

220 - 230 V

Fırça Motoru Devri / Brush Engine Speed

360 dv. / dk

Fırça Motor Basıncı / Brush Engine Pressure

40 Bar

Duvara Montaj Yüksekliği / Mounting Height

1.15 m

Hortum Boyu / Hose Size

2 m veya 2.5 m

Ana Gövde
Main Body

Ağırlık / Weight

27 kg

Genişlik / Width

63 cm

Derinlik / Depth

30 cm

Yükseklik / Height

24 cm

Mobil Araç
Trolley

Ağırlık / Weight

9 kg

Genişlik / Width

55 cm

Derinlik / Depth

62 cm

Yükseklik / Height

80 cm

CANCAN®

• SINCE 1958 •

İşlerinizi Kolaylaştıran Mutfak Ekipmanları
Horeca Equipment For Professionals



CANCAN®

• SINCE 1958 •

CANCAN MEYVE PRESLERİ SAN. VE. TİC. LTD. ŞTİ.

Modern San. Sit. Yeşiltepe Mah. No: 15/1
Adapazarı / SAKARYA / TÜRKİYE

T: +90 (264) 291 49 44
F: +90 (264) 291 49 45
info@cancan.com.tr
www.cancan.com.tr

CANCAN INDUSTRIAL KITCHEN EQUIPMENTS INC

Turkish Trade Center Chicago 2800-2900
Lively Blvd. Elk Grove IL60007

T: +1 847 756 7268
F: +1 847 430 4803

 [cancanmeyvepresleri](#)

 [cancanmeyvepresleri](#)

 [cancanmeyvepresleri](#)