

**BASI REFRIGERATE
REFRIGERATED COUNTERS
KÜHLTISCHEN
TABLES REFRIGEREES
BASES CONGELAD
GEKOELTEN GRONDSLAGEN
ОСНОВЫ РЕФРИЖИРАТОРОВ**



**MANUALE D'USO E INSTALLAZIONE
USE AND INSTALLATION MANUAL
BEDIEN- UND INSTALLATIONSHANDBUCH
MANUEL D'UTILISATION ET D'INSTALLATION
MANUAL DE USO E INSTALACIÓN
GEBRUIKS- EN INSTALLATIEHANDLEIDING
РУКОВОДСТВО ПО ЭКСПЛУАТАЦИИ И УСТАНОВКЕ**

IT

Leggere attentamente le avvertenze contenute nel presente libretto in quanto forniscono importanti indicazioni riguardanti la sicurezza, d'uso e di manutenzione.

Conservare con cura questo libretto per ogni ulteriore consultazione dei vari operatori.

Il costruttore si riserva il diritto di apportare modifiche al presente manuale, senza preavviso e responsabilità alcuna.

GB

Carefully read the instructions contained in the handbook. You may find important safety instructions and recommendations for use and maintenance.

Please retain the handbook for future reference.

The Manufacturer is not liable for any changes to this handbook, which may be altered without prior notice.

DE

Lesen Sie bitte aufmerksam diese Gebrauchsanweisung durch, die wichtige Informationen bezüglich der Sicherheit, dem Gebrauch und der Instandhaltung enthält.

Heben Sie sorgfältig diese Gebrauchsanweisung auf, damit verschiedene Anwender sie zu Rat ziehen können.

Der Hersteller behält sich das Recht, Änderungen dieser Gebrauchsanweisung ohne Ankündigung und ohne Übernahme der Verantwortung vornehmen zu können.

FR

Lire avec attention les instructions contenues dans ce livret car elles fournissent d'importants renseignements pour ce qui concerne la sécurité, l'emploi et l'entretien.

Garder avec soin ce livret pour des consultations ultérieures de différents opérateurs.

Le constructeur se réserve le droit d'apporter des modifications à ce manuel, sans préavis ni responsabilité d'aucune sorte.

ES

Lea atentamente las advertencias contenidas en este manual pues dan importantes indicaciones concernientes la seguridad, la utilización y el mantenimiento del aparato.

Rogamos guarde el folleto de instalación y utilización, para eventuales futuros usuarios.

El constructor se reserva el derecho de hacer modificaciones al actual manual, sin dar algún preaviso y sin responsabilidad alguna.

NL

Nauwkeurig de waarschuwingen in dit boekje lezen, aangezien zij belangrijke aanwijzingen verschaffen wat betreft de veiligheid, het gebruik en het onderhoud.

Dit boekje goed bewaren.

De fabrikant behoudt zich het recht voor om veranderingen in deze handleiding aan te brengen, zonder voorafgaande waarschuwing en zonder enkele aansprakelijkheid.

RU

Внимательно читайте предупреждения, содержащиеся в настоящем руководстве, касающиеся надежности использования и обслуживания.

Конструктор сохраняет за собой право вносить изменения в настоящее руководство без предупреждения и любой ответственности.

INDICE

INFORMAZIONI SULLA SICUREZZA	2
PRESCRIZIONI DI SICUREZZA	2
DESCRIZIONE MACCHINA.....	4
ETICHETTA DI IDENTIFICAZIONE	4
MISURE D'INGOMBRO	5
MESSA IN OPERA ED INSTALLAZIONE	7
PULIZIA E MANUTENZIONE GENERALE	8
MANUTENZIONE APPARECCHI ACCIAIO INOSSIDABILE	8
MANUTENZIONE APPARECCHI VX-PET.....	10
SMALTIMENTO RIFIUTI E DISMISSIONE.....	10
NOTE GENERALI ALLA CONSEGNA	11
ACCESSORI	11
PRESCRIZIONI HACCP.....	11
CARATTERISTICHE TECNICHE.....	12
PANNELLI DI COMANDO	13
AVVIAMENTO E FUNZIONAMENTO	13
BLOCCO/SBLOCCO DELLA TASTIERA.....	13
SETPOINT DI LAVORO E PARAMETRI DI CONFIGURAZIONE	14
GESTIONE UMIDITA' (<i>solo sugli apparecchi Pastry & Bakery</i>).....	21
ALLARMI E SEGNALAZIONI	21
SBRINAMENTO	24
CARICAMENTO PRODOTTO.....	24
ARRESTO.....	24
IRREGOLARITA' DI FUNZIONAMENTO	25
INTERRUZIONI D'USO	25
PROBLEMI DI FUNZIONAMENTO	25
SCHEDA TECNICA DEL REFRIGERANTE.....	26
TARGA SCHEMA ELETTRICO	26

INFORMAZIONI SULLA SICUREZZA

AVVERTENZA: Questo armadio contiene idrocarburi refrigeranti (R290).

PERICOLO: Rischio di incendio o di esplosione. Viene usato un refrigerante infiammabile. Non usare dispositivi meccanici per sbrinare il refrigeratore. Non forare i tubi del refrigerante.

PERICOLO: Rischio di incendio o di esplosione. Viene usato un refrigerante infiammabile. Affidare le riparazioni solamente a personale qualificato. Non forare i tubi del refrigerante.

ATTENZIONE: Rischio di incendio o di esplosione. Viene usato un refrigerante infiammabile. Consultare il manuale operativo/delle riparazioni prima di tentare di intervenire su questo prodotto. Osservare tutte le precauzioni di sicurezza.

ATTENZIONE: Rischio di incendio o di esplosione. Smaltire opportunamente in conformità alla normativa vigente. Viene usato un refrigerante infiammabile.

ATTENZIONE: Rischio di incendio o di esplosione a seguito della puntura dei tubi di refrigerante; attenersi con cura alle istruzioni per la movimentazione. Viene usato un refrigerante infiammabile.

ATTENZIONE: Non conservare all'interno dell'apparecchio sostanze esplosive quali contenitori sotto pressione con propellente infiammabile.

ATTENZIONE: Mantenere prive di ostruzioni tutte le aperture di ventilazione dell'apparecchio del dispositivo o della struttura in cui tale armadio andrà incorporato.



Segnale di pericolo di infiammabilità causa presenza di fluido frigorifero infiammabile (R290)

Le istruzioni sono reperibili sul website www.sagispa.it.

PRESCRIZIONI DI SICUREZZA

Gli apparecchi sono dotati di cavo di alimentazione con spina.

ATTENZIONE: prima di qualsiasi operazione di manutenzione o pulizia bisogna isolare l'apparecchiatura dall'energia elettrica:

– portare l'interruttore generale nella posizione OFF.

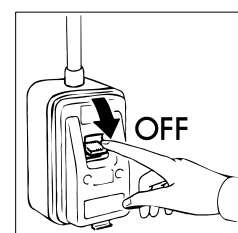

– togliere la spina. La rimozione della spina deve essere tale che l'operatore possa verificare da ogni punto di lavoro la sua disinserizione.

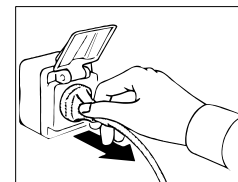

ATTENZIONE: non impiegare prese o spine non provviste di messa a terra.

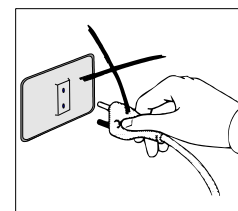

La presa di rete deve essere provvista di MESSA A TERRA.

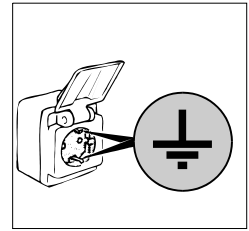

ATTENZIONE: non usare per il collegamento alla rete adattatori o prolunghe.

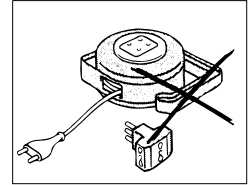

ATTENZIONE: nel caso in cui il cavo di alimentazione sia danneggiato, deve essere sostituito utilizzando un ricambio originale, da un servizio di assistenza o da personale qualificato.

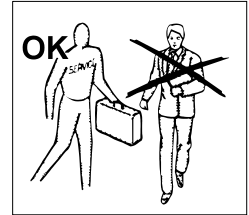

La pulizia e la manutenzione dell'impianto refrigerante e della zona compressori richiede l'intervento di un tecnico specializzato e autorizzato, per questo motivo non può essere effettuata da personale non idoneo.

Per interventi di manutenzione o in caso di anomalie disinserire completamente l'apparecchiatura; richiedere l'intervento del SERVIZIO ASSISTENZA ad un centro autorizzato e l'impiego di ricambi originali. L'inadempienza di quanto sopra può compromettere lo stato di sicurezza degli apparecchi.

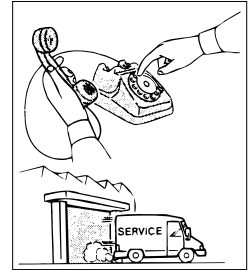

ATTENZIONE: dopo la sua messa in funzione attendere un tempo necessario al raggiungimento della temperatura impostata prima di inserire il cibo da conservare.

Coprire sempre gli alimenti con le apposite pellicole prima di inserirli negli apparecchi.

ATTENZIONE: non introdurre negli apparecchi bevande o cibi caldi.

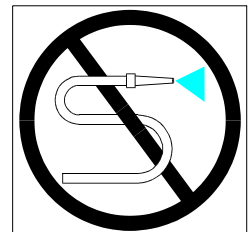

ATTENZIONE: non effettuare le pulizie delle zone circostanti gli apparecchi quando la porta è aperta.

Non lavare l'apparecchio con getti di acqua diretti e ad alta pressione.

ATTENZIONE: non usare sostanze a base di cloro (candeggina, acido muriatico, ecc) o comunque tossiche per la pulizia o in vicinanza degli apparecchi.

ATTENZIONE: non utilizzare dispositivi meccanici ne altri mezzi per accelerare il processo di sbrinamento diversi da quelli raccomandati dal costruttore.

ATTENZIONE: non utilizzare degli apparecchi elettrici all'interno degli scomparti.



L'apparecchiatura è progettata per un livello di pressione sonora inferiore a 70db(A)

MISURE D'INGOMBRO

Consultate le misure del Vostro apparecchio.

- *Modelli prof.600*

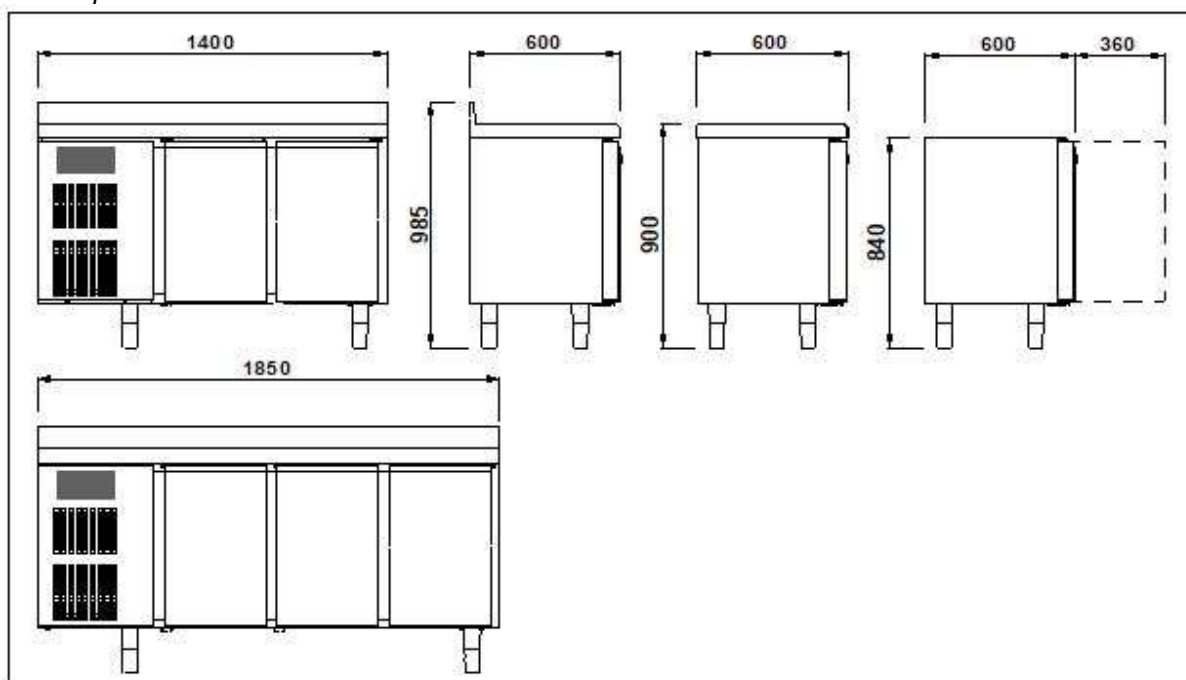

- *Modelli prof.700*

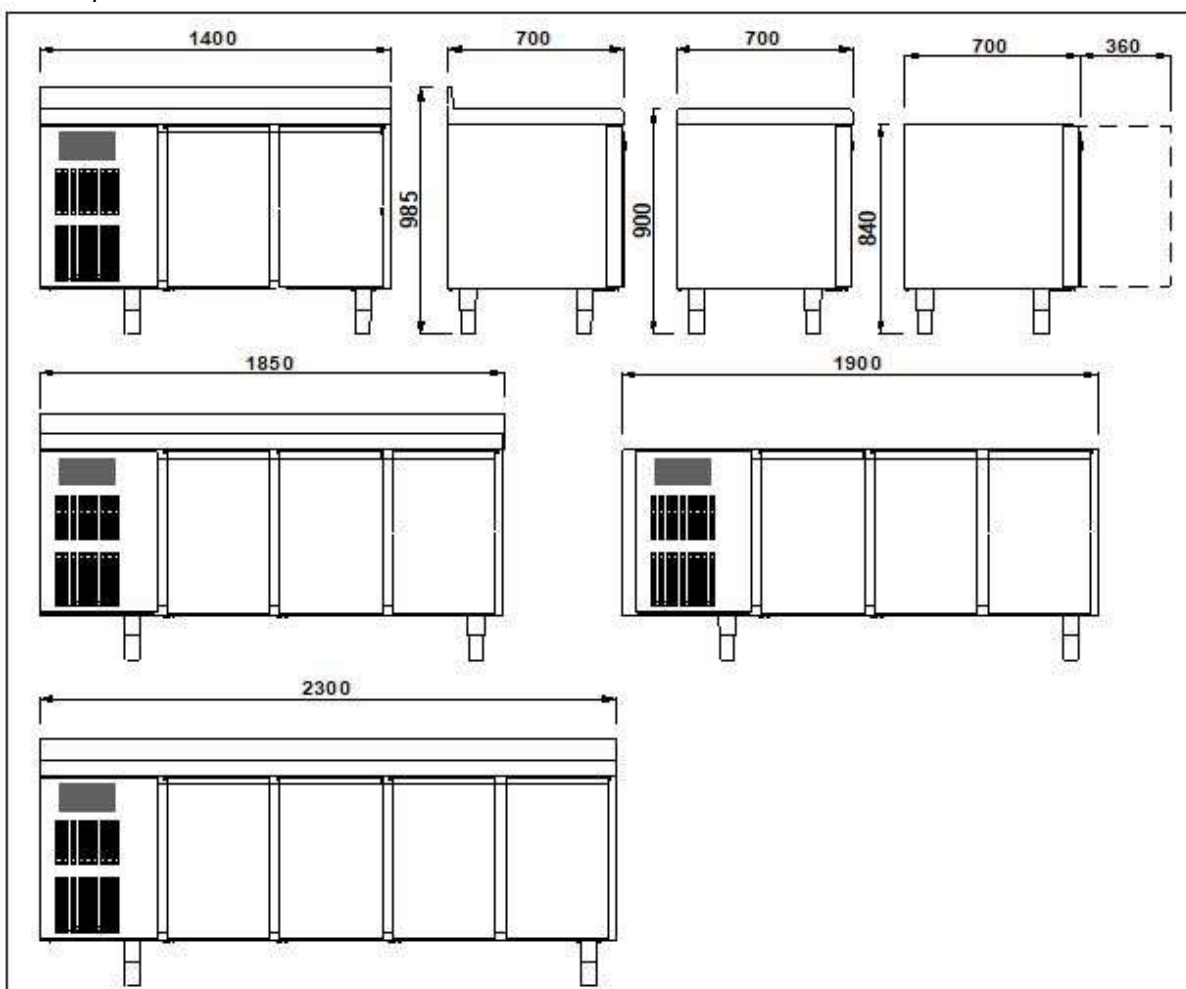

- *Modelli snack*

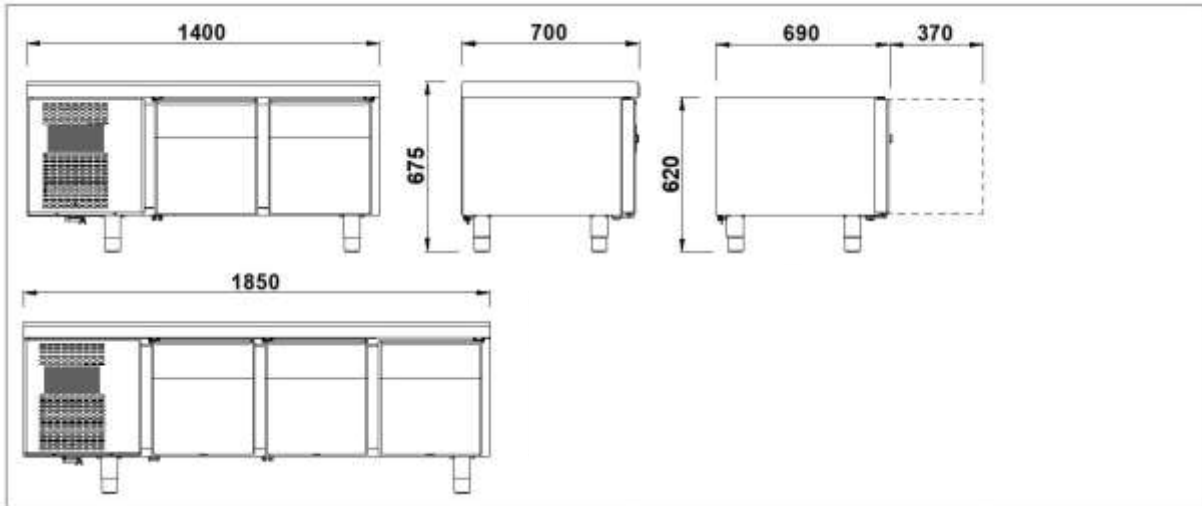

- *Modelli pastry & bakery*

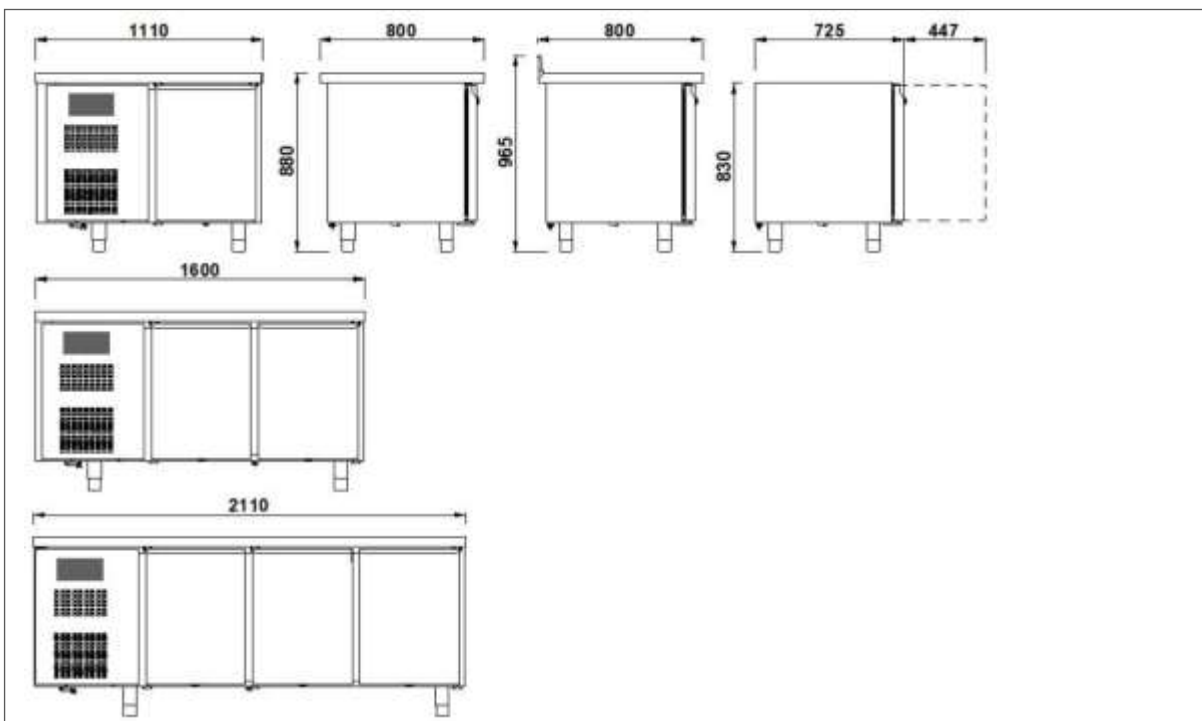

- *Modelli pizza*

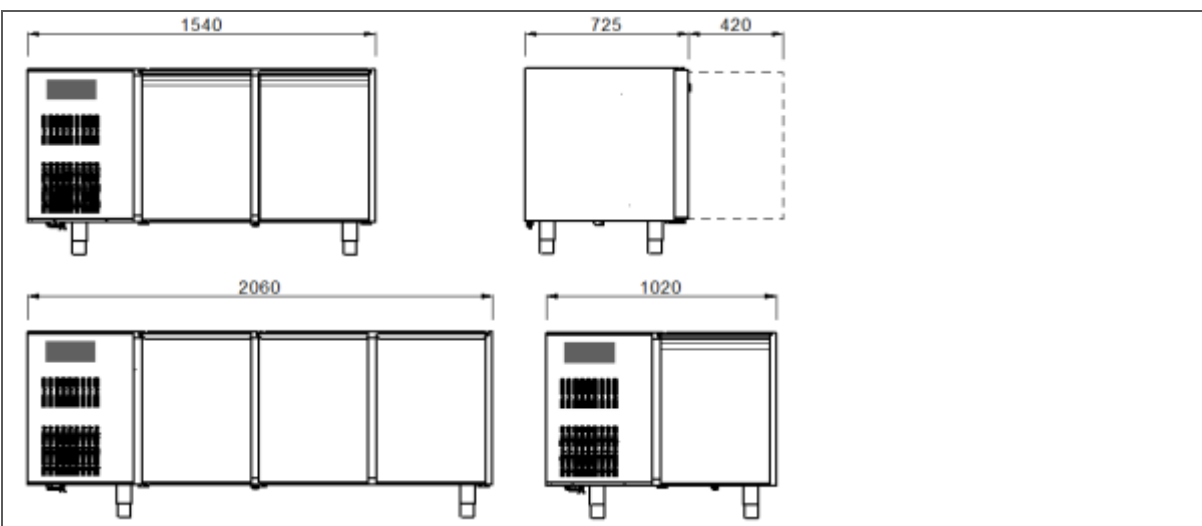

MESSA IN OPERA ED INSTALLAZIONE

Gli apparecchi vengono sempre spediti su pallet e con imballo in cartone di protezione.

Al ricevimento e dopo aver effettuato lo sballaggio in caso di danni o parti mancanti comportarsi come descritto al capitolo "NOTE GENERALI ALLA CONSEGNA".

Le operazioni di messa in opera e di installazione devono essere effettuate da personale specializzato.



Rimuovere la scatola imballo facendo attenzione a non ammaccare le superfici dell'apparecchiatura.

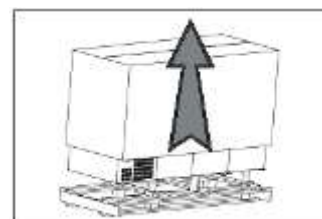

ATTENZIONE: gli elementi dell'imballaggio (sacchetti in plastica, polistirolo espanso, chiodi, ecc...) non devono essere lasciati alla portata dei bambini in quanto potenziali fonti di pericolo

Con un carrello a forche sollevare l'apparecchio e portarlo sul luogo di installazione facendo attenzione che il carico non sia sbilanciato.

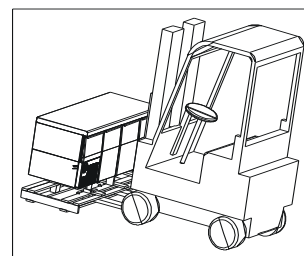

ATTENZIONE: sia per il posizionamento sul posto di installazione come per gli spostamenti futuri non spingere o trascinare l'apparecchio, per evitare che si ribalti o creare danni ad alcune parti dello stesso.

ATTENZIONE: non posizionare l'apparecchio vicino a fonti di calore o in ambienti con temperatura elevate; questo potrebbe causare minor rendimento dello stesso e una eccessiva sollecitazione dell'impianto di refrigerazione.



Collocare l'apparecchio nella sua posizione definitiva.

Accertarsi che il locale sia adeguatamente ventilato. Non allocare l'apparecchiatura in ambienti con temperatura superiore alla classe climatica dichiarata.

Togliere la pellicola protettiva dal prodotto.

Questa operazione può provocare scosse fastidiose, anche se non pericolose (elettricità statica). L'inconveniente si riduce o si elimina mantenendo una mano sempre a contatto con l'apparecchio o collegando a terra l'involucro esterno.

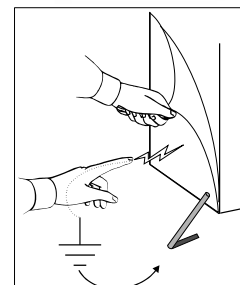

A questo punto è possibile regolare i piedi dell'apparecchio per livellarlo.

Livellare l'apparecchio tenendolo leggermente inclinato sul retro per facilitare la chiusura ottimale delle porte.

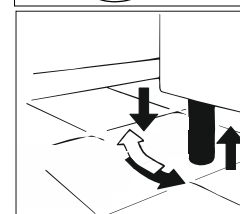

Pulire con acqua tiepida e sapone neutro (come descritto al capitolo "PULIZIA") e montare gli eventuali accessori.

Verificare che la tensione di rete corrisponda a quella riportata sulla targhetta delle caratteristiche tecniche dell'apparecchio.

ATTENZIONE: verificare che la presa di rete sia predisposta di messa a terra; in caso contrario provvedere.

Inserire quindi la spina nell'apposita presa di rete.

L'apparecchiatura deve essere inoltre inclusa in un sistema equipotenziale la cui efficienza deve essere verificato secondo le norme in vigore. Il collegamento viene effettuato mediante una vite contrassegnata dalla sigla "Equipotenziale" posta nella zona compressori.

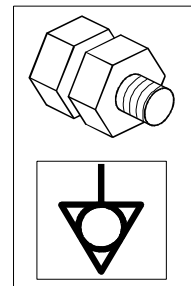

A questo punto le operazioni di messa in opera sono terminate.

PULIZIA E MANUTENZIONE GENERALE

Per un costante rendimento dell'apparecchio è bene compiere le operazioni di pulizia e manutenzioni generali.

Prima di iniziare con le operazioni procedere come segue:

- portare l'interruttore generale nella posizione OFF
- togliere la spina dalla presa e attendere che sia avvenuto il completo sbrinamento dell'armadio.

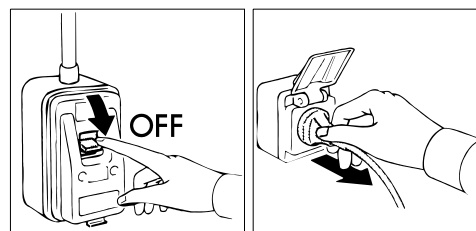

Con un'aspirapolvere, un pennello o una spazzola non metallica pulire con cura il gruppo refrigerante ed in particolar modo la batteria alettata.

ATTENZIONE: La pulizia e la manutenzione dell'impianto refrigerante e della zona compressori richiede l'intervento di un tecnico specializzato e autorizzato, per questo motivo non può essere effettuato da personale non idoneo.

Pulire le superfici interne con acqua e sapone o detergente neutro; un poco di aceto aggiunto all'acqua eliminerà eventuali cattivi odori.

Risciacquare abbondantemente con acqua pura e asciugare con cura.

A questo punto le operazioni di manutenzione e pulizia generali sono terminate.

MANUTENZIONE APPARECCHI ACCIAIO INOSSIDABILE

PULIZIA GIORNALIERA

Per garantire una perfetta igiene e conservazione dell'apparecchio è bene effettuare ordinariamente e/o giornalmente le operazioni di pulizia come di seguito indicato:

1. Pulire accuratamente le superfici dell'apparecchio passandole con una spugna morbida immersa in acqua e detersivo neutro, e strizzata, unicamente nel senso della satinatura.
2. Il detersivo non deve contenere cloro e non deve essere abrasivo.
 - 2.a I detersivi consigliati sono quelli del tipo:
 - Detergente disinfettante ad azione combinata; (contenente tensioattivi non ionici, benzalconio cloruro, sostanze chelanti e pH tampone)
 - Detergente per laboratorio, neutro, per lavaggio manuale;

- (contenente tensioattivi anionici e no ionici)
- Sgrassante per ambienti alimentari;
(contenente tensioattivi anionici ed EDTA)

3. Prima dell'uso diluire eventualmente i detersivi secondo le istruzioni riportate in etichetta.
4. Lasciare agire i detersivi per almeno 5 minuti.
5. Risciacquare accuratamente le pareti dell'apparecchio con una spugna passata più volte in acqua corrente.
6. Asciugare con cura utilizzando una spugna pulita.

ATTENZIONE: non usare nel modo più assoluto utensili o corpi che possono produrre incisioni con la conseguente formazione di ruggine.

MACCHIE DI CIBO E RESIDUI INDURITI

In caso di presenza nell'apparecchio di macchie da cibo o residui lavare con acqua ed asportarli prima che questi possano indurire.

Se i residui sono già induriti procedere come segue:

1. Usare una spugna morbida immersa in acqua tiepida e detersivo neutro (si possono usare quelli previsti per la pulizia giornaliera, alla concentrazione più alta tra quelle previste in etichetta).
2. Inumidire il residuo indurito in modo da mantenerlo umido per almeno 30 minuti ripassando ogni circa 5 minuti la spugna immersa in acqua e detersivo sullo sporco indurito.
3. Alla fine dell'ammollo asportare il residuo con la spugna immersa in acqua e detersivo neutro.
4. Se occorre, ricorrere ad una spatola di legno o a paglietta fine di acciaio inox, avendo cura di non danneggiare la superficie dell'apparecchio.
5. Al termine del procedimento si consiglia un ciclo di pulizia giornaliera di tutte le superfici interne dell'apparecchio.
6. A pulizia ultimata risciacquare accuratamente con una spugna passata più volte in acqua corrente.
7. Asciugare con cura utilizzando una spugna pulita.

Anche le zone sottostanti e adiacenti devono essere pulite e mantenute in perfetta igiene.
Pulire con acqua e sapone o detersivo neutro.

Proteggere le lamiere con cera ai siliconi.

CONSIGLI UTILI PER LA MANUTENZIONE DELL'ACCIAIO INOSSIDABILE

Per la pulizia e manutenzione delle parti costruite in acciaio inossidabile, attenersi a quanto di seguito specificato, tenendo presente che la prima e fondamentale regola è di garantire la non tossicità e la massima igiene dei prodotti trattati.

L'acciaio inossidabile ha un sottile strato di ossido che impedisce la formazione di ruggine.

Ci sono sostanze o detersivi che però possono distruggere o intaccare questo strato e dare così origine a corrosioni.

Prima di usare qualsiasi prodotto detersivo informatevi sempre presso il vostro fornitore di fiducia quale è il tipo più adatto di detersivo neutro che non provoca corrosioni sull'acciaio.

In caso di graffi sulle superfici è necessario levigarle con lana di ACCIAIO INOX finissima o spugnette abrasive di materiale sintetico fibroso strofinando nel senso della satinatura.

ATTENZIONE: Per la pulizia dell'ACCIAIO INOX non usare mai pagliette di ferro e non lasciarle appoggiate sopra alle superfici in quanto i depositi ferrosi molto piccoli potrebbero rimanere sulle superfici e provocare formazione di ruggine per contaminazione e compromettere lo stato d'igiene.

MANUTENZIONE APPARECCHI VX-PET

Per garantire una perfetta igiene e conservazione dell'apparecchio è bene effettuare ordinariamente e/o giornalmente le operazioni di pulizia.

In caso di presenza di macchie da cibo o residui sulla superficie esterna, lavare con acqua ed asportarli prima che questi possano indurire.

Se i residui sono già induriti usare una spugna morbida immersa in acqua acida o alcool denaturato.

In caso di presenza di macchie da cibo o residui sulla superficie interna, usare aceto bianco bollente o alcool denaturato utilizzando un panno morbido per la pulizia.

Pulire nel verso della satinatura.

Si consiglia un ciclo di pulizia giornaliera di tutte le superfici interne dell'apparecchio.

Evitare di utilizzare creme abrasive o pagliette in acciaio inox, acetone, trielina e ammoniacca.

A pulizia ultimata risciacquare accuratamente con una spugna passata più volte in acqua corrente.

Asciugare con cura utilizzando una spugna pulita.

Anche le zone sottostanti e adiacenti devono essere pulite e mantenute in perfetta igiene.

Pulire con acqua e sapone o detergente neutro.

SMALTIMENTO RIFIUTI E DISMISSIONE

STOCCAGGIO RIFIUTI

Alla fine del ciclo di vita del prodotto, non disperdere nell'ambiente l'apparecchiatura. Le porte dovranno essere smontate prima dello smaltimento dell'apparecchiatura.

E' ammesso uno stoccaggio provvisorio di rifiuti speciali in vista di uno smaltimento mediante trattamento e/o stoccaggio definitivo. Vanno comunque osservate le leggi vigenti nel paese dell'utilizzatore in materia di tutela dell'ambiente.

PROCEDURA SMONTAGGIO APPARECCHIATURA

Nei vari Paesi sono in vigore legislazioni differenti, pertanto si devono osservare le prescrizioni imposte dalle leggi e dagli enti preposti dai Paesi dove avviene la demolizione.

In generale è necessario riconsegnare l'apparecchio ai centri specializzati per la raccolta e demolizione. Smontare l'apparecchio raggruppando i componenti secondo la loro natura chimica, ricordando che nel compressore vi è olio lubrificante e fluido refrigerante, che possono essere recuperati e riutilizzati e che i componenti dell'apparecchio sono rifiuti speciali assimilabili agli urbani.

Rendere inutilizzabile l'apparecchiatura per lo smaltimento rimuovendo il cavo di alimentazione e qualsiasi dispositivo di chiusura vani per evitare che qualcuno possa rimanere chiuso al suo interno.

LE OPERAZIONI DI SMONTAGGIO DEVONO ESSERE ESEGUITE DA PERSONALE QUALIFICATO.

SICUREZZA PER LO SMALTIMENTO DI RIFIUTI DI APPARECCHIATURE ELETTRICHE ED ELETTRONICHE (DIRETTIVA RAEE 2002/96)

Non disperdere materiale inquinante nell'ambiente. Effettuare lo smaltimento nel rispetto delle leggi vigenti in materia.

In riferimento alla direttiva RAEE 2002/96 (Rifiuti di Apparecchiature Elettriche ed Elettroniche), l'utilizzatore, in fase di dismissione, deve smaltire le apparecchiature negli appositi centri di raccolta autorizzati, oppure riconsegnarli ancora installati al venditore all'atto di un nuovo acquisto.

Tutte le apparecchiature, che devono essere smaltite secondo la direttiva RAEE 2002/96, sono contrassegnate da un apposito simbolo .

Lo smaltimento abusivo dei Rifiuti di Apparecchiature Elettriche ed Elettroniche è punito con sanzioni regolate dalle leggi vigenti nel territorio in cui viene accertata l'infrazione.

I Rifiuti di Apparecchiature Elettriche ed Elettroniche possono contenere sostanze pericolose con effetti potenzialmente nocivi sull'ambiente e sulla salute delle persone. Si raccomanda di effettuare lo smaltimento in modo corretto.

NOTE GENERALI ALLA CONSEGNA

Alla consegna verificare che l'imballo sia integro e che durante il trasporto non abbia subito danni.

Dopo aver sballato l'apparecchio verificare che vi siano tutte le parti o componenti e che le caratteristiche e lo stato corrispondano alle specifiche dell'ordine da voi richieste.
Se così non fosse mettersi immediatamente in contatto con il rivenditore.

Nel complimentarci per la scelta ci auguriamo che possiate utilizzare al meglio le nostre basi refrigerate seguendo le indicazioni e le precauzioni necessarie contenute in questo manuale.

Ma ricordate che è vietata qualsiasi riproduzione del presente manuale e che per una costante ricerca di innovazione e qualità tecnologica le caratteristiche qui riportate potrebbero cambiare senza preavviso.

ACCESSORI

A richiesta l'apparecchiatura può essere corredata dei seguenti accessori (*vedi "catalogo generale"*).

PRESCRIZIONI HACCP

ATTENZIONE: Verdure crude, uova e pollame **NON** possono essere conservati negli stessi ambienti refrigerati. Il pollame va conservato in apposito ambiente refrigerato.

ATTENZIONE: Evitare di conservare alimenti che abbiano una temperatura compresa tra 10°C e 60°C. Utilizzare idonee apparecchiature (abbattitori di temperatura) per ridurre la temperatura al cuore dell'alimento.

ATTENZIONE: Nel prelevare alimenti dall'apparecchio si deve controllare la data di scadenza impressa sulle confezioni, e prendere quelli con la scadenza più vicina. Se si nota un'alimento scaduto, lo si toglie dall'apparecchio e lo si elimina segnalando l'accaduto al responsabile dell'Azienda in cui lavorate.

ATTENZIONE: I prodotti facilmente deperibili devono essere tolti dall'ambiente refrigerato il più tardi possibile al fine di restare esposti alla temperatura ambiente il tempo indispensabile.

ATTENZIONE: Non ricongelare alimenti precedentemente scongelati.

ATTENZIONE: Numerare le attrezzature e controllare due volte al giorno la temperatura rilevata registrando i valori su apposito foglio da conservare per 24 mesi.

ATTENZIONE: Eventuali interruzioni di corrente all'apparecchio possono essere effettuate controllando il tempo di fermo tramite un orologio elettrico al fine di eliminare gli alimenti che potrebbero danneggiarsi.

Temperature massime ammesse per le merci

Alimento	Temperatura normale di stoccaggio (°C)	Temperatura massima di trasporto (°C)
Latte fresco pastorizzato	0÷+4	9
Panna fresca	0÷+4	9
Yoghurt, ricotta e formaggi freschi	0÷+2	9
Prodotti della pesca sotto ghiaccio	0÷+2	0÷+4
Carni bovine e suine	0÷+3	10
Pollame	0÷+4	8
Coniglio	0÷+2	8
Selvaggina piccola	0÷+2	8
Selvaggina grande	0÷+2	8
Frattaglie	0÷+3	8
Surgelati	-23÷-24	-18
Gelati confezionati	-18÷-20	-18
Frutta e verdura	0÷+4	ambiente

CARATTERISTICHE TECNICHE

I dati tecnici sono riportati nell'ultima pagina del libretto.

PANNELLI DI COMANDO

Tutti gli apparecchi sono dotati di un interruttore generale e di un termoregolatore:

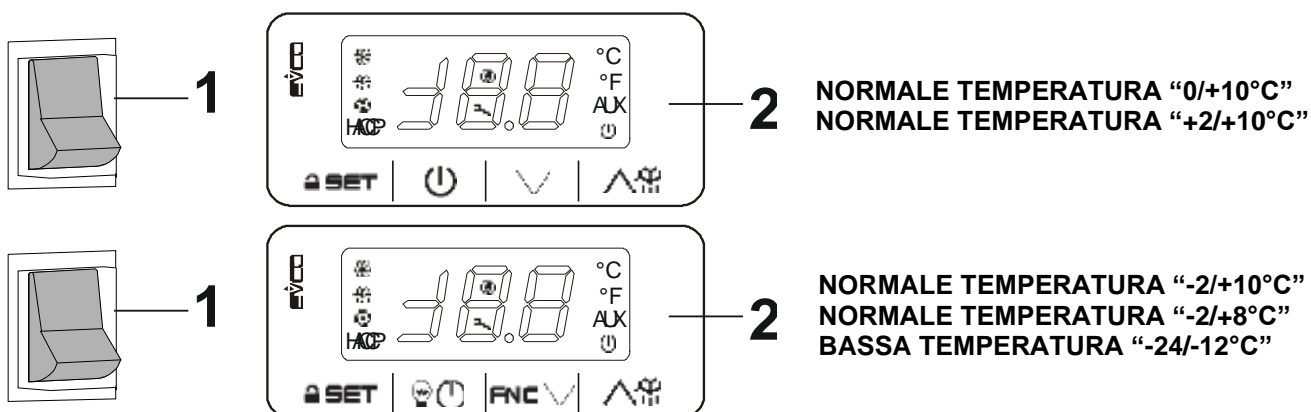

AVVIAMENTO E FUNZIONAMENTO

Per avviare l'apparecchio eseguire le seguenti operazioni:

- inserire la spina nell'apposita presa di rete;
- portare l'interruttore di linea in posizione ON;
- premere l'interruttore generale (1);
a questo punto è possibile impostare la temperatura di funzionamento tramite una adeguata impostazione del termoregolatore (2).

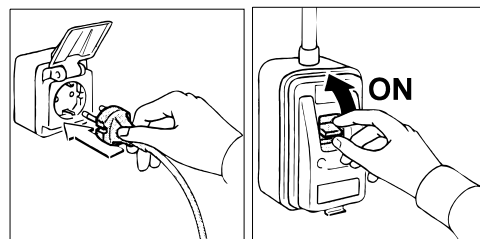

Verificare sul display del termoregolatore (2), dopo un tempo necessario, che la temperatura interna degli apparecchi corrisponda alla temperatura impostata.

BLOCCO/SBLOCCO DELLA TASTIERA

Per bloccare la tastiera:

- assicurarsi che non sia in corso alcuna procedura
- non operare per 30 s: il display visualizzerà "Loc" per 1 s e la tastiera si bloccherà automaticamente.

Se la tastiera è bloccata, non sarà consentito:

- accendere/spengere il dispositivo
- visualizzare la temperatura rilevata dalle sonde
- attivare lo sbrinamento in modo manuale
- modificare il setpoint di lavoro

Queste operazioni provocano la visualizzazione della label "Loc" per 1 s.





Per sbloccare la tastiera:

- premere un tasto per 1 s: il display visualizzerà "UnL" per 1 s.

SETPOINT DI LAVORO E PARAMETRI DI CONFIGURAZIONE

NORMALE TEMPERATURA "0/+10°C" "+2/+10°C"

Impostazione del setpoint di lavoro

- assicurarsi che la tastiera non sia bloccata e che non sia in corso alcuna procedura
- premere **SET** il LED  lampeggerà
- agendo su  o  entro 15 s; si vedano anche i parametri r1 e r2
- dopo la modifica premere **SET** per confermare o, in alternativa, non operare per 15 s, il LED  si spegnerà, dopodiché il dispositivo uscirà dalla procedura.

Per uscire anzitempo dalla procedura:

- toccare il tasto  (eventuali modifiche non saranno salvate)



È inoltre possibile impostare il setpoint di lavoro attraverso il parametro **SP**.

Setpoint di lavoro



LABEL	MIN.	MAS.	U.M.	SETPOINT DI LAVORO
r1		r2	°C/°F (1)	setpoint di lavoro; si vedano anche r0 e r12

Impostazione dei parametri di configurazione

Per accedere alla procedura:

- assicurarsi che non sia in corso alcuna procedura
- toccare il tasto **SET** per 4 s: il display visualizzerà "PA"
- toccare il tasto **SET**
- toccare il tasto  o il tasto  impostare il valore stabilito con il parametro "PAS" (per impostazione di fabbrica il parametro è impostato a -19°)
- toccare il tasto **SET** o non operare per 15 s: il display visualizzerà "SP"

Per selezionare un parametro:

- toccare il tasto  o il tasto 

Per modificare il valore di un parametro:

- toccare il tasto **SET**
- toccare il tasto  o il tasto  entro 15 s
- toccare il tasto **SET** o non operare per 15 s

Per uscire dalla procedura:

- toccare il tasto **SET** per 4 sec o non operare per 60 sec (eventuali modifiche saranno salvate)

Parametri di configurazione

LABEL	MIN.	MAS.	U.M.	SETPOINT DI LAVORO
SP	r1	r2	°C/°F (1)	setpoint di lavoro; si vedano anche r0 e r12

LABEL	MIN.	MAS.	U.M.	INGRESSI ANALOGICI
CA1	-25	25	°C/°F (1)	offset sonda ambiente
CA2	-25	25	°C/°F (1)	se P4=1, offset sonda evaporatore se P4=2, offset sonda condensatore
P0	0	1	-	tipo di sonda 0=PTC; 1=NTC
P1	0	1	-	punto decimale grado Celsius (per la grandezza visualizzata durante il normale funzionamento) (1=S)
P2	0	1	-	unità di misura temperatura (2) 0 = °C (grado Celsius; la risoluzione dipende dal parametro P1) 1 = °F (grado Fahrenheit; la risoluzione è di 1 °F)
P4	0	2	-	funzione del secondo ingresso 0 = ingresso digitale (micro porta o multifunzione) 1 = ingresso analogico (sonda evaporatore) 2 = ingresso analogico (sonda condensatore)
P5	0	2	-	grandezza visualizzata durante il normale funzionamento 0 = temperatura ambiente 1 = setpoint di lavoro 2 = se P4=0 " - - -" se P4=1, temperatura dell'evaporatore se P4=1, temperatura del condensatore
P8	0	250	0,1s	ritardo visualizzazione variazione di temperature rilevate dalle sonde

LABEL	MIN.	MAS.	U.M.	REGOLATORE PRINCIPALE
r0	0.1	15	°C/°F (1)	differenziale del setpoint di lavoro; si veda anche r12
r1	-99	r2	°C/°F (1)	minimo setpoint di lavoro
r2	r1	99	°C/°F (1)	massimo setpoint di lavoro
r4	0	99	°C/°F (1)	incremento del setpoint di lavoro durante la funzione "energy saving"; si vedano anche i0, i10 e HE2
r5	0	1	-	funzionamento per freddo o caldo 0= per freddo 1= per caldo
r12	0	1	-	Tipo di differenziale del setpoint di lavoro

				0 = asimmetrico 1 = simmetrico
--	--	--	--	-----------------------------------

LABEL	MIN.	MAS.	U.M.	PROTEZIONE COMPRESSORE
C0	0	240	min	ritardo compressore dall'accensione dello strumento
C2	0	240	min	durata minima dello spegnimento del compressore
C3	0	240	s	durata minima dell'accensione del compressore
C4	0	240	min	durata dello spegnimento del compressore durante l'errore sonda cella (codice Pr1); si veda anche C5
C5	0	240	min	durata dell'accensione del compressore durante l'errore sonda cella (codice Pr1); si veda anche C4
C6	0	199	°C/°F (1)	temperatura del condensatore al di sopra della quale viene attivato l'allarme condensatore surriscaldato (codice COH) (6)
C7	0	199	°C/°F (1)	temperatura del condensatore al di sopra della quale viene attivato l'allarme compressore bloccato (codice CSd)
C8	0	15	min	ritardo allarme compressore bloccato (codice CSd) (7)

LABEL	MIN.	MAS.	U.M.	SBRINAMENTO
d0	0	99	h	se d8 = 0, 1 o 2 intervallo di sbrinamento 0 = lo sbrinamento a intervalli non verrà mai attivato se d8 = 3, massimo intervallo di sbrinamento
d2	-99	99	°C/°F (1)	temperatura dell'evaporatore di fine sbrinamento; si veda anche d2
d3	0	99	min	durata dello sbrinamento se P4 = 0 o 2; durata massima dello sbrinamento se P4 = 1 0 = lo sbrinamento non verrà mai attivato
d4	0	1	-	sbrinamento all'accensione dello strumento (4) (1 = SI)
d5	0	99	min	se d4 = 0, tempo minimo tra l'accensione del dispositivo e l'attivazione dello sbrinamento (4) se d4 = 1 ritardo sbrinamento dall'accensione dello strumento (4)
d6	0	2	-	temperatura visualizzata durante lo sbrinamento (solo se P5 = 0) 0=temperatura ambiente 1=se all'attivazione dello sbrinamento la temperatura ambiente è al di sotto di "setpoint di lavoro + Δt", al massimo "setpoint di lavoro + Δt"; se all'attivazione dello sbrinamento la temperatura ambiente è al di sopra di "setpoint di lavoro + Δt", al massimo la temperatura della cella all'attivazione dello sbrinamento (8)(9) 2 = label "dEF"
d7	0	15	min	durata del gocciolamento (durante il gocciolamento il compressore rimarrà spento)
d8	0	3	-	tipo di intervallo di sbrinamento 0 = A INTERVALLI – PER TEMPO – lo sbrinamento verrà attivato quando lo strumento sarà rimasto acceso per il tempo d0 1 = A INTERVALLI – PER ACCENSIONE DEL COMPRESSORE – lo sbrinamento verrà attivato quando il compressore sarà rimasto acceso per il tempo d0 2 = A INTERVALLI – PER TEMPERATURA DELL'EVAPORATORE – lo sbrinamento verrà attivato quando la temperatura dell'evaporatore sarà rimasta al di sotto della temperatura d9 per il tempo d0 (10) 3 = ADATTATIVO - lo sbrinamento verrà attivato ad intervalli la cui durata sarà ogni volta in funzione della durata delle accensioni del compressore, della temperatura dell'evaporatore e dell'attivazione dell'ingresso micro porta; si vedano anche d18, d19, d20, d22 i13 e i14 (10)
d9	-99	99	°C/°F (1)	temperatura dell'evaporatore al di sopra della quale il conteggio dell'intervallo di sbrinamento viene sospeso (solo se d8 = 2)
d11	0	1	-	abilitazione dell'allarme sbrinamento concluso per durata massima (codice dFd); solo se P4=1 e in assenza di errore sonda evaporatore (codice Pr2) 1 = SI
d16	0	999	min	durata del pregocciolamento (durante il pregocciolamento il compressore rimarrà spento, l'uscita di sbrinamento verrà attivata e il ventilatore dell'evaporatore rimarrà spento)
d18	0	999	min	intervallo di sbrinamento (lo sbrinamento verrà attivato quando il compressore sarà rimasto acceso complessivamente, con la temperatura dell'evaporatore al di sotto della temperatura d22, per il tempo d18; solo se d8=3) 0 = lo sbrinamento non verrà mai attivato per effetto di questa condizione
d19	0	40	°C/°F (1)	temperatura dell'evaporatore al di sotto della quale viene attivato lo sbrinamento (relativa alla media delle temperature dell'evaporatore, ovvero "media delle temperature dell'evaporatore - d19") (solo se d8=3)
d20	0	999	min	durata minima consecutiva dell'accensione del compressore tale da provocare l'attivazione dello sbrinamento 0 = lo sbrinamento non verrà mai attivato per effetto di questa condizione
d22	0	19,9	°C/°F (1)	temperatura dell'evaporatore al di sopra della quale il conteggio dell'intervallo di sbrinamento viene sospeso (relativa alla media delle temperature dell'evaporatore, ovvero "media delle temperature dell'evaporatore + d22") (solo se d8=3); si veda anche d18

LABEL	MIN.	MAS.	U.M.	ALLARMI DI TEMPERATURA (11) (12)
A1	0	99	°C/°F (1)	temperatura al di sotto della quale viene attivato l'allarme di temperatura di minima (codice AL); relativo al setpoint di lavoro ovvero "setpoint di lavoro" - A1); si veda anche A11 0=allarme assente
A4	0	99	°C/°F (1)	temperatura al di sopra della quale viene attivato l'allarme di temperatura di massima (codice AH); relativo al setpoint di lavoro ovvero "setpoint di lavoro" + A4); si veda anche A11 0=allarme assente
A6	0	99	10 min	ritardo allarme di temperatura di massima (codice AH) dall'accensione dello strumento
A7	0	199	min	ritardo allarme di temperatura di minima (codice AL) e di massima (codice AH)
A11	0,1	15	°C/°F (1)	differenziale dei parametri A1 e A4

LABEL	MIN.	MAS.	U.M.	INGRESSI DIGITALI
i0	0	4	-	effetto provocato dall'attivazione dell'ingresso digitale 0 = nessun effetto 1 = MICRO PORTA – ATTIVAZIONE DELL'ALLARME INGRESSO MICRO PORTA (codice id) – il compressore verrà spento (al massimo per il tempo i3 o fino a quando l'ingresso verrà disattivato); si veda anche i2 (13) 2 = MULTIFUNZIONE – ATTIVAZIONE DELLA FUNZIONE "ENERGY SAVING" – verrà attivata la funzione "energy saving" (con effetto solo sul compressore, fino a quando l'ingresso verrà disattivato); si veda anche r4 3 = MULTIFUNZIONE – ATTIVAZIONE DELL'ALLARME INGRESSO MULTIFUNZIONE (codice iA) –

				il dispositivo continuerà a funzionare regolarmente; si veda anche i2 4 = MULTIFUNZIONE – ATTIVAZIONE DELL'ALLARME DPRESSOSTATO (codice iA) – il compressore verrà spento (fino a quando l'ingresso verrà disattivato); si veda anche i2
i1	0	1	-	tipo di contatto dell'ingresso digitale 0 = normalmente aperto (ingresso attivo con contatto chiuso) 1 = normalmente chiuso (ingresso attivo con contatto aperto)
i2	-1	120	min	se i0 = 1, ritardo segnalazione allarme ingresso micro porta (codice id) -1 = l'allarme non verrà segnalato se i0 = 3, ritardo segnalazione allarme ingresso multifunzione (codice iA) -1 = l'allarme non verrà segnalato Se i0 = 4, ritardo accensione compressore dalla disattivazione dell'allarme pressostato (codice iA) -1 = riservato
i3	-1	120	min	durata massima dell'effetto provocato dall'attivazione dell'ingresso micro porta sul compressore -1 = l'effetto durerà fino a quando l'ingresso verrà disattivato
i10	0	999	min	tempo che deve trascorrere in assenza di attivazioni dell'ingresso micro porta (dopo che la temperatura ambiente ha raggiunto il setpoint di lavoro) affinché la funzione "energy saving" venga attivata; si veda anche r4 e HE2) 0 = la funzione non verrà mai attivata per effetto di questa condizione
i13	0	240	-	numero di attivazioni dell'ingresso micro porta tale da provocare l'attivazione dello sbrinamento 0 = lo sbrinamento non verrà mai attivato per effetto di questa condizione
i14	0	240	min	durata minima dell'attivazione dell'ingresso micro porta tale da provocare l'attivazione dello sbrinamento 0 = lo sbrinamento non verrà mai attivato per effetto di questa condizione







LABEL	MIN.	MAS.	U.M.	ENERGY SAVING
HE2	0	99	min	durata massima della funzione "energy saving" attivata per effetto dell'assenza di attivazioni dell'ingresso micro porta; si vedano anche r4 e i10 0 = la funzione durerà fino a quando l'ingresso verrà attivato
HE3	0	240	min	tempo che deve trascorrere in assenza di operazioni con i tasti affinché la modalità "basso consumo" venga attivata 0 = la modalità non verrà mai attivata

LABEL	MIN.	MAS.	U.M.	VARIE
POF	0	1	-	attivazione del tasto  1 = SI
PAS	-99	999	-	Password di accesso ai parametri di configurazione 0 = la password non dovrà essere impostata

- (1) l'unità di misura dipende dal parametro P2
(2) impostare opportunamente i parametri relativi ai regolatori dopo la modifica del parametro P2
(3) se il parametro r5 è impostato a 1, la funzione "energy saving" e la gestione dello sbrinamento non sarà abilitata
(4) il parametro ha effetto anche dopo un'interruzione dell'alimentazione che si manifesta quando il dispositivo è acceso
(5) il tempo stabilito con il parametro viene conteggiato anche quando il dispositivo è spento
(6) il differenziale del parametro è di 2°C/4°F
(7) se l'accensione del dispositivo la temperatura del condensatore è già al di sopra di quella stabilita con il parametro C7, il parametro C8 non avrà effetto
(8) il valore di Δt dipende dal parametro r12 (r0 se r12 = 0, r0/2 se r12 = 1)
(9) il display ripristina il normale funzionamento quando, concluso lo sbrinamento, la temperatura della cella scende al di sotto di quella che ha bloccato il display (o se si manifesta un allarme di temperatura)
(10) se il parametro P4 è impostato a 0 o 2, il dispositivo funzionerà come se il parametro d8 fosse impostato a 0
(11) durante lo sbrinamento gli allarmi di temperatura sono assenti, a condizione che questi si siano manifestati dopo l'attivazione dello sbrinamento
(12) durante l'attivazione dell'ingresso micro porta l'allarme di temperatura di massima è assente, a condizione che questi si sia manifestato dopo l'attivazione dell'ingresso
(13) il compressore viene spento trascorsi 10 s dall'attivazione dell'ingresso.

NORMALE TEMPERATURA “-2/+10°C” “-2/+8°C” - BASSA TEMPERATURA “-24/-12°C”

Impostazione del setpoint di lavoro

- assicurarsi che la tastiera non sia bloccata e che non sia in corso alcuna procedura
- premere  il LED  lampeggerà
- agendo su  o  entro 15 s; si vedano anche i parametri r1 e r2
- dopo la modifica premere  per confermare o, in alternativa, non operare per 15 s, il LED  si spegnerà, dopodiché il dispositivo uscirà dalla procedura.

Per uscire anzitempo dalla procedura:

- toccare il tasto  (eventuali modifiche non saranno salvate)





È inoltre possibile impostare il setpoint di lavoro attraverso il parametro **SP**.

Setpoint di lavoro

LABEL	MIN.	MAS.	U.M.	SETPOINT DI LAVORO
r1	r2		°C/°F	setpoint di lavoro; si vedano anche r0 e r12

Impostazione dei parametri di configurazione

Per accedere alla procedura:

- assicurarsi che non sia in corso alcuna procedura
- toccare il tasto  per 4 s: il display visualizzerà "PA"
- toccare il tasto 
- toccare il tasto  o il tasto  impostare il valore stabilito con il parametro "PAS" (per impostazione di fabbrica il parametro è impostato a -19°)

- toccare il tasto **SET** o non operare per 15 s: il display visualizzerà "SP"

Per selezionare un parametro:

- toccare il tasto **▲** o il tasto **FNC**

Per modificare il valore di un parametro:

- toccare il tasto **SET**
- toccare il tasto **▲** o il tasto **FNC** entro 15 s
- toccare il tasto **SET** o non operare per 15 s

Per uscire dalla procedura:

- toccare il tasto **SET** per 4 sec o non operare per 60 sec (eventuali modifiche saranno salvate)

Parametri di configurazione

LABEL	MIN.	MAS.	U.M.	SETPOINT DI LAVORO
SP	r1	r2	°C/°F	setpoint di lavoro; si vedano anche r0 e r12

LABEL	MIN.	MAS.	U.M.	INGRESSI ANALOGICI
CA1	-25	25	°C/°F	offset sonda cella se P4 = 3, offset sonda aria
CA2	-25	25	°C/°F	offset sonda evaporatore
CA3	-25	25	°C/°F	offset sonda ausiliaria
P0	0	1	-	tipo di sonda 0=PTC 1=NTC
P1	0	1	-	abilita punto decimale °C 0 = no 1 = sì
P2	0	1	-	unità di misura temperatura (2) 0=°C (grado Celsius; la risoluzione dipende dal parametro P1) 1=°F (grado Fahrenheit; la risoluzione è di 1 °F)
P3	0	2	-	funzione della sonda evaporatore 0 = disabilitata 1 = sbrinamento + ventole 2 = ventole
P4	0	3	-	funzione ingresso configurabile 0 = ingresso digitale 1 = sonda condensatore 2 = sonda temperatura critica 3 = sonda aria in uscita se P4 = 3, temperatura regolazione = temperatura prodotto (CPT)
P5	0	4	-	grandezza a display 0 = temperatura regolazione 1 = setpoint 2 = temperatura evaporatore 3 = temperatura ausiliaria 4 = temperatura aria in ingresso
P7	0	100	%	peso aria in ingresso per calcolo temperatura prodotto (CPT) CPT = (((P7 x (aria in ingresso)) + [(100 - P7) x (aria in uscita)]; 100)
P8	0	250	0,1 s	tempo rinfresco display

LABEL	MIN.	MAS.	U.M.	REGOLAZIONE
r0	0.1	15	°C/°F	differenziale setpoint
r1	-99	r2	°C/°F	setpoint minimo
r2	r1	99	°C/°F	setpoint massimo
r4	0	99	°C/°F	offset setpoint in energy saving
r5	0	1	-	regolazione per caldo o per freddo 0=per freddo 1=per caldo
r6	0	99	°C/°F	offset setpoint in overcooling/overheating
r7	0	240	min	durata overcooling/overheating
r8	0	2	-	funzione supplementare tastoDOWN 0 = disabilitato 1 = overcooling/overheating 2 = energy saving
r12	0	1	-	posizione differenziale r0 0=asimmetrico 1=simmetrico

LABEL	MIN.	MAS.	U.M.	COMPRESSORE
C0	0	240	min	ritardo compressore on da power-on
C2	0	240	min	tempo minimo compressore off
C3	0	240	s	tempo minimo compressore on
C4	0	240	min	tempo compressore off in allarme sonda cella
C5	0	240	min	tempo compressore on in allarme sonda cella
C6	0	200	°C/°F	soglia segnalazione alta conden sazione
C7	0	200	°C/°F	soglia allarme alta condensazione
C8	0	15	min	ritardo allarme alta condensazione
C10	0	9999	h	ore compressore per manutenzione 0 = disabilitato
C11	0	240	s	ritardo accensione compressore 2
C12	0	10	-	numero spunti per rotazione compressori 0 = disabilitato

LABEL	MIN.	MAS.	U.M.	SBRINAMENTO
d00	0	1	-	abilita parametri tipo b 0 = no 1 = si
d01	r1	r2	°C/°F	soglia setpoint per abilitazione parametri tipo b se SP > d01
d0	0	99	h	intervallo sbrinamento automatico 0 = solo manuale se d8 = 3, intervallo massimo
d0b	0	99	h	intervallo sbrinamento automatico 0 = solo manuale se d8 = 3, intervallo massimo
d1	0	2	-	tipo di sbrinamento 0 = elettrico 1 = a gas caldo 2 = per fermata compressore
d1b	0	2	-	tipo di sbrinamento 0 = elettrico 1 = a gas caldo 2 = per fermata compressore
d2	-99	99	°C/°F	soglia fine sbrinamento
d2b	-99	99	°C/°F	soglia fine sbrinamento
d3	0	99	min	durata sbrinamento se P3 = 1, durata massima
d3b	0	99	min	durata sbrinamento se P3 = 1, durata massima
d4	0	1	-	abilita sbrinamento al power-on 0 = no 1 = si
d5	0	99	min	ritardo sbrinamento da power-on
d6	0	2	-	grandezza a display in sbrinamento 0 = temperatura regolazione 1 = display bloccato 2 = label dEF
d7	0	15	min	tempo gocciolamento
d7b	0	15	min	tempo gocciolamento
d8	0	3	-	modalità conteggio intervallo sbrinamento 0 = ore dispositivo on 1 = ore compressore on 2 = ore temperatura evaporatore < d9 3 = adattativo 4 = in tempo reale
d9	-99	99	°C/°F	soglia evaporazione per conteggio intervallo sbrinamento automatico
d11	0	1	-	abilita allarme timeout sbrinamento 0 = no 1 = si se d1 = 0 o 1, abilitato con SP < 0, se d1 = 2, disabilitato
d15	0	99	min	tempo consecutivo compressore on per sbrinamento a gas caldo
d16	0	99	min	tempo pre-gocciolamento per sbrinamento a gas caldo
d18	0	999	min	intervallo sbrinamento adattativo se compressore on + temperatura evaporatore < d22 0 = solo manuale
d19	0	40	°C/°F	soglia per sbrinamento adattativo (relativa a temperatura ottimale evaporazione) temperatura ottimale evaporazione - d19
d20	0	999	min	tempo consecutivo compressore on per sbrinamento 0 = disabilitato
d21	0	500	min	tempo consecutivo compressore on per sbrinamento da power-on e da overcooling se (temperatura regolazione - setpoint) > 10°C/20 °F 0 = disabilitato
d22	0	10	°C/°F	soglia evaporazione per conteggio intervallo sbrinamento adattativo (relativa a temperatura ottimale evaporazione) temperatura ottimale evapo razione + d22

LABEL	MIN.	MAS.	U.M.	ALLARMI
AA	0	2	-	selezione grandezza per allarmi alta/bassa temperatura 0 = temperatura regolazione 1 = temperatura evaporatore 2 = temperatura ausiliaria
A1	0	99	°C/°F	soglia allarme bassa temperatura
A2	0	2	-	tipo di allarme bassa temperatura 0 = disabilitato 1 = relativo a setpoint 2 = assoluto
A4	0	99	°C/°F	soglia allarme alta temperatura
A5	0	2	-	tipo di allarme alta temperatura 0 = disabilitato 1 = relativo a setpoint 2 = assoluto
A6	0	99	10 min	ritardo allarme alta temperatura da power-on
A7	0	240	min	ritardo allarmi alta/bassa temperatura
A8	0	240	min	ritardo allarme alta temperatura post sbrinamento
A9	0	240	min	ritardo allarme alta temperatura da chiusura porta
A10	0	240	min	durata power failure per memorizzazione allarme
A11	0,1	15	°C/°F	differenziale ripristino allarmi alta/bassa temperatura

LABEL	MIN.	MAS.	U.M.	VENTOLE
F0	0	4	-	modalità ventole evaporatore in normale funzionamento

				0 = off 1 = on 2 = funzione di F15 e F16 se compressore off, on se compressore on 3 = termoregolate (con F1 e F1A) 4 = termoregolate (con F1 e F1A) se compressore on
F0b	0	4	-	modalità ventole evaporatore in normale funzionamento 0 = off 1 = on 2 = funzione di F15 e F16 se compressore off, on se compressore on 3 = termoregolate (con F1 e F1A) 4 = termoregolate (con F1 e F1A) se compressore on
F1	-99	99	°C/°F	soglia ventole evaporatore off
F1A	-99	99	°C/°F	soglia ventole evaporatore on se F1A > F1, differenziale F1 = 2 °C/4 °F
F2	0	2	-	modalità ventole evaporatore in sbrinamento e gocciolamento 0 = off 1 = on 2 = funzione di F0
F2b	0	2	-	modalità ventole evaporatore in sbrinamento e gocciolamento 0 = off 1 = on 2 = funzione di F0
F3	0	15	min	tempo massimo fermo ventole evaporatore
F3b	0	15	min	tempo massimo fermo ventole evaporatore
F4	0	240	10 s	tempo ventole evaporatore off in energy saving
F5	0	240	10 s	tempo ventole evaporatore on in energy saving
F7	-99	99	°C/°F	soglia ventole evaporatore on da gocciolamento (relativa a setpoint)
F9	0	240	s	ritardo ventole evaporatore off da compressore off
F10	0	99	°C/°F	differenza "temperature cella - temperature evaporatore" per ventole evaporatore on
F11	0	99	°C/°F	soglia ventole condensatore on
F12	0	240	s	ritardo ventole condensatore off da compressore off
F13	0	15	°C/°F	differenziale F11
F15	0	240	s	tempo ventole evaporatore off con compressore off se F0 = 2
F16	0	240	s	tempo ventole evaporatore on con compressore off se F0 = 2

LABEL	MIN.	MAS.	U.M.	INGRESSI DIGITALI
i0	0	5	-	funzione ingresso micro porta 0 = disabilitato 1 = compressore + ventole evaporatore off 2 = ventole evaporatore off 3 = luce cella on 4 = compressore + ventole evaporatore off, luce cella on 5 = ventole evaporatore off, luce cella on
i1	0	1	-	attivazione ingresso micro porta 0 = con contatto chiuso 1 = con contatto aperto
i2	-1	120	min	ritardo allarme porta aperta -1 = disabilitato
i3	-1	120	min	tempo massimo inibizione regolazione con porta aperta -1 = fino alla chiusura
i5	0	7	-	funzione ingresso micro porta/multifunzione 0 = disabilitato 1 = energy saving 2 = allarme iA 3 = carico da tasto on 4 = accende/spegne dispositivo 5 = allarme Cth 6 = allarme th 7 = compressore + ventole evaporatore off, luce cella on 8 = ventole evaporatore off, luce cella on
i6	0	1	-	attivazione ingresso micro porta/ multifunzione 0 = con contatto chiuso 1 = con contatto aperto
i7	0	120	min	ritardo allarme ingresso multifunzione -1 = disabilitato se i5 = 5 o 6, ritardo compressore on da ripristino allarme
i10	0	999	min	tempo consecutivo porta chiusa per energy saving dopo che temperatura regolazione < SP 0 = disabilitato
i13	0	240	-	numero aperture porta per sbrinamento 0 = disabilitato
i14	0	240	min	tempo consecutivo porta aperta per sbrinamento 0 = disabilitato

LABEL	MIN.	MAS.	U.M.	USCITE DIGITALI
uc1	0	12	-	configurazione relè K1 0 = compressore 1 = sbrinamento 2 = ventole evaporatore 3 = luce cella 4 = antiappannamento 5 = carico da tasto 6 = allarme 7 = resistenze porta 8 = resistenze per zona neutra 9 = ventole condensatore

				10= on/stand-by 11= compressore 2 12= disabilitato
uc2	0	12	-	configurazione relè K2 (come uc1)
uc3	0	12	-	configurazione relè K3 (come uc2)
uc4	0	12	-	configurazione relè K4 (come uc3)
u2	0	1	-	abilita luce cella e carico da tasto in stand-by 0 = no 1 = sì in modo manuale
u4	0	1	-	abilita tacitazione uscita allarme 0 = no 1 = sì
u5	-99	99	°C/°F	soglia resistenze porta on differenziale = 2 °C/4 °F
u6	0	120	min	durata antiappannamento on 0 = solo manuale
u7	-99	99	°C/°F	soglia zona neutra per riscaldamento (relativa a setpoint) setpoint + u7
u8	1	15	°C/°F	differenziale di u7

LABEL	MIN.	MAS.	U.M.	ENERGY SAVING (se r5 = 0)
HE2	0	999	min	durata massima energy saving -1 = fino all'apertura porta

LABEL	MIN.	MAS.	U.M.	ENERGY SAVING IN TEMPO REALE (se r5 = 0)
H01	0	23	h	orario energy saving giornaliero
H02	0	24		durata massima energy saving giornaliero

LABEL	MIN.	MAS.	U.M.	SBRINAMENTO IN TEMPO REALE (se d8 = 4)
Hd1	-	-	-	orario 1° sbrinamento giornaliero h- = disabilitato
Hd2	-	-	-	orario 2° sbrinamento giornaliero h- = disabilitato
Hd3	-	-	-	orario 3° sbrinamento giornaliero h- = disabilitato
Hd4	-	-	-	orario 4° sbrinamento giornaliero h- = disabilitato
Hd5	-	-	-	orario 5° sbrinamento giornaliero h- = disabilitato
Hd6	-	-	-	orario 6° sbrinamento giornaliero h- = disabilitato

LABEL	MIN.	MAS.	U.M.	SICUREZZE
Pbu	0	2	-	selezione evento per attivazione buzzer 0 = disabilitato 1 = allarmi 2 = tasti e allarmi
POF	0	1	-	abilita tasto ON/STAND-BY 0 = no 1 = sì
PAS	-99	999	-	password
PA1	-99	999	-	password 1° livello
PA2	-99	999	-	password 2° livello





LABEL	MIN.	MAS.	U.M.	OROLOGIO
POF	0	1	-	abilita orologio 0 = no 1 = sì

LABEL	MIN.	MAS.	U.M.	DATA-LOGGING EVLINK
bLE	0	99	-	configurazione porta seriale perconnettività 0 = libera 1 = forzata per EVconnect o EPoCA 2... 99 = indirizzo rete locale EPoCA
rE0	0	240	min	intervallo campionamento data-logger
rE1	0	5	-	selezione temperatura per data-logger 0 = nessuna 1 = cella 2 = evaporatore 3 = ausiliaria 4 = cella ed evaporatore 5 = tutte

LABEL	MIN.	MAS.	U.M.	MODBUS
LA	1	247	-	indirizzo MODBUS
Lb	0	3	-	baud rate MODBUS 0 = 2.400 baud 1 = 4.800 baud 2 = 9.600 baud 3 = 19.200 baud parità even

GESTIONE UMIDITA' (solo sugli apparecchi Pastry & Bakery)





È possibile decidere il valore di umidità desiderato a seconda del tipo di alimenti che si vuole conservare:

- assicurarsi che la tastiera non sia bloccata e che non sia in corso alcuna procedura
- premere il tasto **FNC**  per 2 s: il display visualizzerà la label relativa alla impostazione dell'umidità (rH⁺ = alta umidità oppure rH⁻ = bassa umidità)
- premere il tasto **SET**  per 2 s per modificare l'impostazione
- dopo la modifica premere il tasto   per confermare ed uscire dalla procedura.

ALLARMI E SEGNALAZIONI

NORMALE TEMPERATURA "0/+10°C" "+2/+10°C"

Segnalazioni

LED	SIGNIFICATO
	LED compressore se è acceso, il compressore è acceso se lampeggia: • sarà in corso l'impostazione del setpoint di lavoro • sarà in corso una protezione del compressore
	LED sbrinamento se è acceso, sarà in corso lo sbrinamento se lampeggia, sarà in corso il gocciolamento
	LED energy saving se è acceso e il display è acceso, sarà in corso la funzione "energy saving" se è acceso e il display è spento, sarà in corso la modalità "basso consumo"; toccare un tasto per ripristinare la normale visualizzazione
°C	LED grado Celsius se è acceso, l'unità di misura delle temperature è il grado Celsius
°F	LED grado Fahrenheit se è acceso, l'unità di misura delle temperature è il grado Fahrenheit
	LED on/stand-by se è acceso, il dispositivo sarà spento (stato "stand-by")

Indicazioni

CODICE	SIGNIFICATO
Loc	la tastiera è bloccata
- - -	il funzionamento richiesto non è disponibile
dEF	è in corso lo sbrinamento

Allarmi

CODICE	SIGNIFICATO
AL	Allarme di bassa temperatura nel vano Rimedi: - verificare la temperatura; si veda il parametro A1 Principali conseguenze: - il dispositivo continuerà a funzionare regolarmente
AH	Allarme di alta temperatura nel vano Rimedi: - verificare la temperatura; si veda il parametro A4 Principali conseguenze: - il dispositivo continuerà a funzionare regolarmente
id	Allarme ingresso micro porta Rimedi: - verificare le cause che hanno provocato l'attivazione dell'ingresso; si vedano i parametri i0e i1 Principali conseguenze: - l'effetto stabilito con il parametro i0
dFd	Allarme sbrinamento concluso per durata massima Rimedi:

	<ul style="list-style-type: none"> - verificare l'integrità della sonda evaporatore; si vedano i parametri d2, d3 e d11 - toccare un tasto per ripristinare la normale visualizzazione Principali conseguenze: <ul style="list-style-type: none"> - il dispositivo continuerà a funzionare regolarmente
--	--

Quando la causa che ha provocato l'allarme scompare, lo strumento ripristina il normale funzionamento, salvo per i seguenti allarmi:

- l'allarme compressore bloccato (codice "Csd") che necessita dello spegnimento del dispositivo o dell'interruzione dell'alimentazione
- l'allarme sbrinamento concluso per durata massima (codice "dFd") che necessita della pressione di un tasto.







Errori

CODICE	SIGNIFICATO
Pr1	Errore sonda vano Rimedi: <ul style="list-style-type: none"> - verificare che la sonda sia di tipo PTC o NTC; si veda il parametro P0 - verificare il collegamento dispositivo-sonda - verificare la temperatura ambiente Principali conseguenze: <ul style="list-style-type: none"> - l'attività del compressore dipenderà dai parametri C4 e C5 - lo sbrinamento non verrà mai attivato
Pr2	Errore sonda evaporatore/defrost Rimedi: <ul style="list-style-type: none"> - gli stessi del caso precedente ma relativamente alla sonda evaporatore o alla sonda condensatore Principali conseguenze: <ul style="list-style-type: none"> - se il parametro P4 è impostato a 1, lo sbrinamento durerà il tempo stabilito con il parametro d3 - se il parametro P4 è impostato a 1 e il parametro d8 è impostato a 2 o 3, il dispositivo funzionerà come se il parametro d8 fosse impostato a0 - se il parametro P4 è impostato a 2, l'allarme condensatore surriscaldato (codice "COH") non verrà mai attivato - se il parametro P4 è impostato a 2, l'allarme compressore bloccato (codice "Csd") non verrà mai attivato

Quando la causa che ha provocato l'errore scompare, il dispositivo ripristina il normale funzionamento.

NORMALE TEMPERATURA "-2/+10°C" "-2/+8°C" - BASSA TEMPERATURA "-24/-12°C"

Segnalazioni

LED	SIGNIFICATO
	LED compressore se è acceso, il compressore è acceso se lampeggia: <ul style="list-style-type: none"> • sarà in corso l'impostazione del setpoint di lavoro • sarà in corso una protezione del compressore
	LED sbrinamento se è acceso: <ul style="list-style-type: none"> - sarà in corso lo sbrinamento - sarà in corso il peggioramento se lampeggia: <ul style="list-style-type: none"> - sarà richiesto lo sbrinamento ma sarà in corso una protezione del compressore - sarà in corso il gocciolamento - sarà richiesto lo sbrinamento ma sarà in corso un'accensione minima del compressore
	LED ventilatore dell'evaporatore se è acceso, il ventilatore dell'evaporatore sarà acceso se lampeggia, sarà in corso il fermo ventilatore dell'evaporatore
HACCP	LED allarme HACCP in memoria EVlink
AUX	LED ausiliario se è acceso: <ul style="list-style-type: none"> - le resistenze della porta saranno accese
	LED energy saving se è acceso e il display è acceso, sarà in corso la funzione "energy saving" se è acceso e il display è spento, sarà in corso la modalità "basso consumo"; toccare un tasto per ripristinare la normale visualizzazione
	LED manutenzione se è acceso, sarà richiesta la manutenzione del compressore
°C	LED grado Celsius se è acceso, l'unità di misura delle temperature è il grado Celsius se lampeggia, sarà in corso la funzione "raffreddamento rapido" o la funzione "riscaldamento rapido"
°F	LED grado Fahrenheit se è acceso, l'unità di misura delle temperature è il grado Fahrenheit se lampeggia, sarà in corso la funzione "raffreddamento rapido" o la funzione "riscaldamento rapido"
	LED on/stand-by se è acceso, il dispositivo sarà spento (stato "stand-by")

Indicazioni

CODICE	SIGNIFICATO
Loc	la tastiera è bloccata
- - -	il funzionamento richiesto non è disponibile

Allarmi

CODICE	SIGNIFICATO
rtc	Allarme orologio Rimedi: impostare la data, l'ora e il giorno della settimana
AL	Allarme di bassa temperatura nel vano Rimedi: - verificare la temperatura ambiente o la temperatura CPT; si veda il parametro A1 Principali conseguenze: - l'uscita di allarme verrà attivata
AH	Allarme di alta temperatura nel vano Rimedi: - verificare la temperatura ambiente o la temperatura CPT; si veda il parametro A4 Principali conseguenze: - l'uscita di allarme verrà attivata
id	Allarme ingresso micro porta Rimedi: - verificare le cause che hanno provocato l'attivazione dell'ingresso; si vedano i parametri i0 e i1 Principali conseguenze: - l'effetto stabilito con il parametro i0 - l'uscita di allarme verrà attivata
PF	Allarme power failure Rimedi: - toccare un tasto - verificare il collegamento elettrico
dFd	Allarme sbrinamento concluso per durata massima Rimedi: - verificare l'integrità della sonda evaporatore; si vedano i parametri d2, d3 e d11 - toccare un tasto per ripristinare la normale visualizzazione Principali conseguenze: - il dispositivo continuerà a funzionare regolarmente

Quando la causa che ha provocato l'allarme scompare, lo strumento ripristina il normale funzionamento, salvo per i seguenti allarmi:
 - l'allarme compressore bloccato (codice "CSd") e l'allarme protezione termica globale (codice "th") che necessitano dello spegnimento del dispositivo o dell'interruzione dell'alimentazione
 - l'allarme sbrinamento concluso per durata massima (codice "dFd") che necessita della pressione di un tasto.

Errori

CODICE	SIGNIFICATO
Pr1	Errore sonda vano Rimedi: - verificare che la sonda sia di tipo PTC o NTC; si veda il parametro P0 - verificare il collegamento dispositivo-sonda - verificare la temperatura ambiente/la temperatura CPT Principali conseguenze: - l'attività del compressore dipenderà dai parametri C4 e C5 - se il parametro P4 è impostato a 3, la temperatura associata alla regolazione e agli allarmi di temperatura sarà la temperatura aria in uscita - lo sbrinamento non verrà mai attivato - l'uscita di allarme verrà attivata - le resistenze della porta verranno spente - le resistenze per il funzionamento a zona neutra verranno spente
Pr2	Errore sonda evaporatore/defrost Rimedi: - gli stessi del caso precedente ma relativamente alla sonda evaporatore Principali conseguenze: - se il parametro P3 è impostato a 1, lo sbrinamento durerà il tempo stabilito con il parametro d3 - se il parametro P3 è impostato a 1 e il parametro d8 è impostato a 2 o 3, il dispositivo funzionerà come se il parametro d8 fosse impostato a 0 - se il parametro P3 è impostato a 1 o 2 e il parametro F0 è impostato a 3 o 4, il dispositivo funzionerà come se il parametro fosse impostato a 2 - l'uscita di allarme verrà attivata

Quando la causa che ha provocato l'errore scompare, il dispositivo ripristina il normale funzionamento.

SBRINAMENTO

Lo sbrinamento degli apparecchi è completamente automatico.

Lo sbrinamento degli impianti a "NORMALE TEMPERATURA 0/+10°C ÷ +2/10°C" è ad aria e avviene automaticamente ogni 6 ore. Lo sbrinamento ha una durata di 20 minuti.

Lo sbrinamento degli impianti a "NORMALE TEMPERATURA -2/+10°C ÷ -2/+8°C" è a resistenza e avviene automaticamente ogni 6 ore. La durata del ciclo di sbrinamento viene autoregolata dall'apparecchio.

Lo sbrinamento degli impianti a "BASSA TEMPERATURA -24/-12°C" è a gas caldo e avviene automaticamente ogni 6 ore di funzionamento del compressore. La durata del ciclo di sbrinamento viene autoregolata dall'apparecchio.

È possibile attivare in qualsiasi momento, un ciclo di sbrinamento, premendo per 5 secondi il pulsante "▲❄"; lo sbrinamento automatico successivo avverrà a partire da questo momento dopo 6 ore per gli impianti a "NORMALE TEMPERATURA" e dopo 6 ore di funzionamento del compressore per gli impianti a "BASSA TEMPERATURA".

CARICAMENTO PRODOTTO

- Distribuire il prodotto all'interno dei vani refrigerati in modo uniforme per consentire una buona circolazione dell'aria;
- Evitare di occludere le zone di ventilazione dell'impianto di raffreddamento posto sulla parte sinistra del vano;
- Evitare di riporre gli alimenti che necessitano di basse temperature di conservazione nell'ultimo cassetto in basso a destra;
- Coprire o avvolgere gli alimenti prima di introdurli all'interno dell'apparecchio con apposite pellicole protettive;
- Non introdurre nell'apparecchio cibi o bevande troppo calde;
- Non lasciare le porte aperte più del necessario durante il prelievo o l'introduzione degli alimenti;
- Nel caricare il ripiano superiore non oltrepassare il limite di carico;
- Non posizionare gli alimenti sotto il ripiano inferiore;
- *Modelli Snack*: nel caricare i cassetti inferiori non oltrepassare il limite di carico.

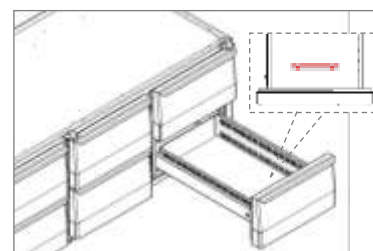
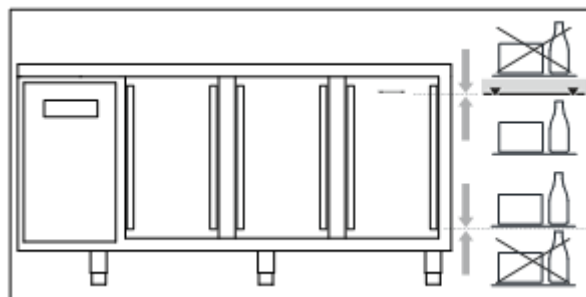

ARRESTO

In qualsiasi condizione e per arrestare l'apparecchiatura è sufficiente premere in posizione OFF l'interruttore generale 1.

ATTENZIONE: il tasto interruttore generale 1 NON isola l'apparecchio dalla tensione elettrica.

Portare l'interruttore di rete in posizione OFF.

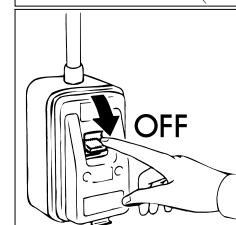
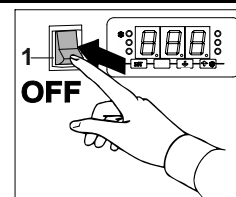

Per isolare l'apparecchio dalla tensione elettrica togliere la spina dalla presa.

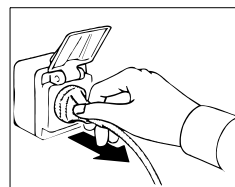

IRREGOLARITA' DI FUNZIONAMENTO

In caso di funzionamento irregolare, prima di interpellare il servizio assistenza di zona, verificare che:

- l'interruttore generale 1 sia acceso e che ci sia tensione in rete;
- il valore della temperatura impostata sia quello desiderato;
- le porte siano perfettamente chiuse;
- l'apparecchio non sia posto vicino a fonti di calore;
- il condensatore sia pulito e il ventilatore funzioni regolarmente;
- non vi sia un'eccessiva brinatura sulla piastra evaporante.

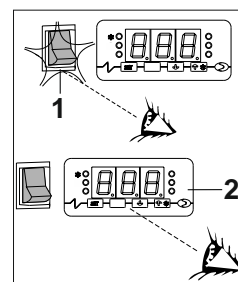

Nel caso che detti controlli abbiano dato esito negativo, rivolgersi al servizio assistenza di zona fornendo indicazioni sul modello e numero di matricola riportati sulla targhetta caratteristica.

INTERRUZIONI D'USO

In caso di prolungata inattività dell'apparecchio e per mantenerlo nelle migliori condizioni operare come segue:

- portare l'interruttore di rete in posizione OFF.
- togliere la spina dalla presa.
- vuotare l'apparecchio e pulirlo come descritto al capitolo "PULIZIA".
- lasciare le porte delle celle socchiuse per evitare la formazione di cattivi odori.

PROBLEMI DI FUNZIONAMENTO

Spesso le difficoltà di funzionamento che si possono verificare sono dovute a cause quasi sempre rimediabili senza l'intervento di un tecnico specializzato. Quindi prima di segnalare un guasto alla rete di assistenza verificare quanto segue:

PROBLEMA	POSSIBILI CAUSE
L'apparecchiatura non si accende	Controllare che la spina sia inserita nella presa di corrente Controllare che alla presa arrivi corrente
La temperatura interna è troppo elevata	Verificare la regolazione del termoregolatore Verificare che non ci sia influenza di una fonte di calore Verificare che la porta chiuda perfettamente
L'apparecchio è eccessivamente rumoroso	Verificare il livellamento dell'apparecchiatura. Una posizione non equilibrata potrebbe innescare delle vibrazioni Controllare che l'apparecchiatura non sia a contatto con altre apparecchiature o parti che potrebbero entrare in risonanza
All'interno dell'apparecchio ci sono odori sgradevoli	Ci sono alimenti dall'odore particolarmente forte (ad esempio formaggio e melone), in contenitori non sigillati Le superfici interne devono essere pulite

Sull'apparecchiatura si forma della condensa	L'umidità ambiente è molto elevata
	Non si sono chiusi bene gli sportelli

Eseguite le verifiche suddette, se il difetto persiste, rivolgetevi all'assistenza tecnica ricordandoVi di segnalare:

- la natura del difetto
- il modello ed il numero di matricola dell'apparecchio che si possono rilevare dalla targa delle caratteristiche elettriche, posta sotto il cruscotto dell'apparecchiatura.

SCHEDA TECNICA DEL REFRIGERANTE

R290

GWP = 3

ODP = 0

❖ Identificazione dei pericoli

Gas liquefatto – Estremamente infiammabile

❖ Misure di primo soccorso

• *Inalazione:*

In alta concentrazione può causare asfissia. I sintomi possono includere perdita di mobilità e/o conoscenza. Le vittime possono non rendersi conto dell'asfissia. In bassa concentrazione può avere effetto narcotico. I sintomi possono includere vertigini, mal di testa, nausea e perdita di coordinazione. Spostare la vittima in zona non contaminata indossando l'autorespiratore. Mantenere il paziente disteso ed al caldo. Chiamare un medico. Procedere alla respirazione artificiale in caso di arresto alla respirazione.

• *Contatto con la pelle e con gli occhi:*

In caso di fuoriuscita lavare con acqua per almeno 15 minuti

• *Ingestione:*

Via di esposizione poco probabile

❖ Informazioni ecologiche

Non si conoscono danni all'ambiente provocati da questo prodotto

TARGA SCHEMA ELETTRICO

Lo schema elettrico è riportato nell'ultima pagina del libretto.

Pos	DESCRIZIONE	Pos	DESCRIZIONE
1	compressore	20C	resistenza porta
2	ventilatore condensatore	21	resistenza di sbrinamento
3	morsettiera	22	resistenza scarico bacinella
6	interruttore generale	44	relé di potenza compressore
8	spina elettrica	69	morsetto di terra
9	ventilatore evaporatore	75	elettrovalvola di mandata
12	elettrovalvola di sbrinamento	88	termoregolatore dgt
20	resistenza porta	90	termoregolatore dgt
20A	resistenza porta	102	termostato bimetallico di sicurezza
20B	resistenza porta		

INDEX

SAFETY INFORMATION	2
SAFETY PRESCRIPTIONS	2
IDENTIFICATION TAG	4
DIMENSIONS.....	5
IMPLEMENTATION AND INSTALLATION.....	7
GENERAL CLEANING AND MAINTENANCE.....	8
WASTE DISPOSAL AND DEMOLITION.....	10
GENERAL NOTES BY THE DELIVERY	11
ACCESSORIES	11
HACCP REGULATIONS.....	11
TECHNICAL SPECIFICATIONS	12
CONTROL PANNELS.....	13
STARTING AND WORKING	13
LOCKING/UNLOCKING THE KEYBOARD	13
WORKING SETPOINT AND CONFIGURATION PARAMETERS.....	14
HUMIDITY MANAGEMENT (<i>only on appliances Pastry & Bakery</i>).....	21
ALARMS AND SIGNALS.....	21
DEFROSTING.....	24
LOADING THE PRODUCT	24
STOPPING.....	24
WORKING IRREGULARITIES.....	25
USAGE INTERRUPTIONS.....	25
MALFUNCTIONING	25
REFRIGERANT MATERIAL SAFETY DATA SHEET	26
WIRING DIAGRAM PLATE.....	26

SAFETY INFORMATION

WARNING: This cabinet contain hydrocarbon refrigerant (R290).

DANGER: Risk of fire or explosion. Flammable refrigerant used. Do not use mechanical devices to defrost refrigerator. Do not puncture refrigerant tubing.

DANGER: Risk of fire or explosion. Flammable refrigerant used. To be repaired only by trained service personnel. Do not puncture refrigerant tubing.

CAUTION: Risk of fire or explosion. Flammable refrigerant used. Consult repair manual/owner's guide before attempting to service this product. All safety precautions must be followed.

CAUTION: Risk of fire or explosion. Dispose of properly in accordance with federal or local regulations. Flammable refrigerant used.

CAUTION: Risk of fire or explosion due to puncture of refrigerant tubing; follow handling instructions carefully. Flammable refrigerant used.

CAUTION: Keep clear of obstruction all ventilation openings in the appliance enclosure or in the structure for building-in.

CAUTION: see to the arrangement of the food products to be conserved inside in such a manner that they do not extend beyond the shelves so as to not interrupt the flow of air inside the unit. Do not obstruct fan intake area.



Signal warning of flammability due to the presence of flammable refrigerant (R290).

Instructions are available on the website www.sagispa.it

SAFETY PRESCRIPTIONS

The appliances are equipped with a power cable with plug.

WARNING: before any maintenance or cleaning operation the machine must be insulated from the current:

– witch the general cut-out in OFF position.

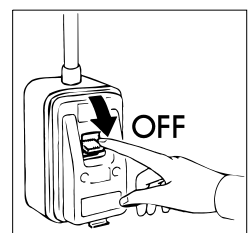

– remove the plug. The removal of the plug must be such that the operator can check its disconnection from every working point.

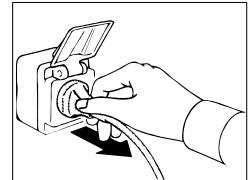

WARNING: do not use current taps or plugs not provided with grounding.

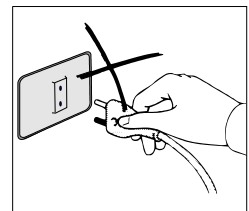

The socket must be provided with GROUNDING.

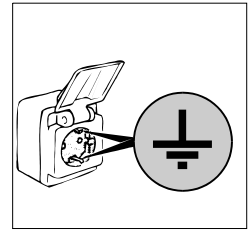

WARNING: do not use adapters or patch cords for the connection to the electric line.

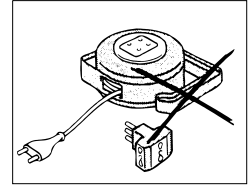

WARNING: if the power supply cable is damaged, it must be replaced using an original spare part, by an assistance service or by qualified personnel.

The cleaning and maintenance of the refrigerating engine and the compressor area needs the intervention of a skilled technician, therefore it cannot be done by other persons.

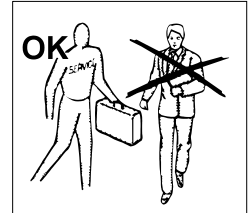

For a maintenance intervention or in case of anomaly disconnect completely the machine; ask for the TECHNICAL SERVICE to an entitled center and the use of original spare parts.

Failure to comply with what is written above may compromise the safety of the units.

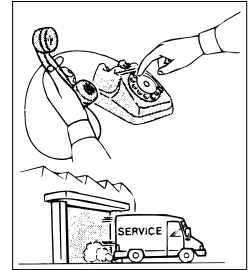

WARNING: after commissioning, wait for a time necessary to reach the set temperature before inserting the food to be stored.

Always cover the food with the special film before to put it into the appliance.

WARNING: do not introduce hot foods or drinks into the appliance.

WARNING: do not do the cleaning around the appliance when the door is open.

Do not wash the appliance by spraying high-pressure water on the machine.

WARNING: do not use substances with base of chlorine (chlorine water, muriatic acid, etc.) or however toxic for the cleaning or near the refrigerators.

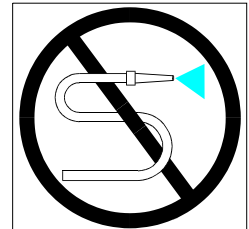

WARNING: Do not use mechanical devices nor other means to speed up the thawing process other than those recommended by the manufacturer.

WARNING: Do not use electrical appliances inside compartments.

The equipment is designed for a sound pressure level below 70db (A).



MACHINE DESCRIPTION

This equipment is intended for use in refrigeration and food storage. Any other use is to be considered improper.

WARNING: the appliances are not suitable for installation outdoors or in environments subject to the action of the elements. Do not use in potentially explosive atmospheres..

The manufacturer cannot be held liable for improper use of its products.

In the upper part the counters are provided with a working top, also available with raised back. Counters without working top having the same refrigerating capacities are also available.

The controls are supplied with digital heat regulator and master switch.

The engine group is located in a specific housing on the left of the counter.

The evaporator is located inside the engine compartment (one for each compartment) and is protected with sheets.

The internal ventilation is provided by means of protected tangential fans located above the evaporator.

The appliance is supplied with an automatic evaporation control for the condensed steam.

The areas that come into contact with the product are in steel or covered in non-toxic plastic material.

In case of machine downtime, ensure proper ventilation, temperature between -20°C +50°C, relative humidity between 30% and 80% and an atmosphere that is dry and not dusty.

IDENTIFICATION TAG

The identification plate is permanently fixed to the product. It supplies important information about the technical and constructive specifications of the counters.

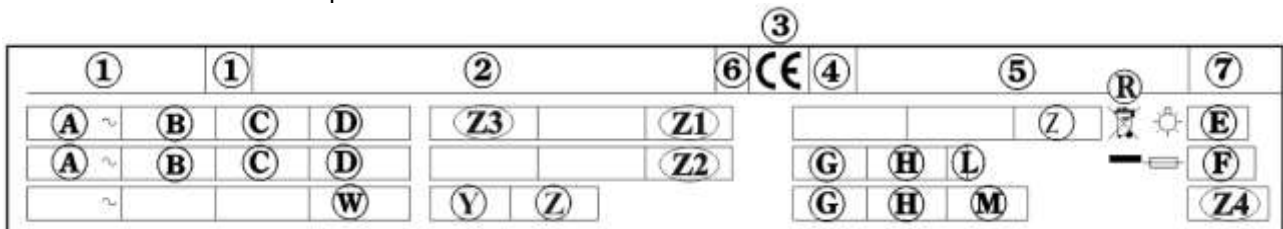

Legend

- | | |
|---|--|
| <ul style="list-style-type: none"> 1) MODEL 2) MANUFACTURARIS NAME AND ADDRESS 3) CE MARK 4) YEAR OF MAKE 5) SERIAL NUMBER 6) ELECTRIC INSULATING GRADE 7) ELECTRIC PROTECTION GRADE A) POWER SUPPLY VOLTAGE B) ELECTRIC CURRENT RATE C) POWER SUPPLY FREQUENCY D) RATED POWER | <ul style="list-style-type: none"> E) TOTAL LAMP POWER F) FUSIBLE CURRENT G) REFRIGERATING FLUID TYPE H) REFRIGERATING FLUID QUANTITY L) AMBIENT TEMPERATURE R) WEEE SYMBOL W) HEATING SECTION POWER Z1) RATED STORAGE VOLUME (RSV) Z2) FLUID FOAMING Z3) TEMPERATURE RANGE Z4) GWP |
|---|--|

Climate Class*	Ambient temperature
3 (SN)	+10°C ---> +32°C
4 (N)	+16°C ---> +32°C
4+ (ST)	+16°C ---> +38°C
4+ (SN-ST)	+10°C ---> +38°C
5 (T)	+16°C ---> +43°C
5 (SN-T)	+10°C ---> +43°C

(*)The climate class temperature indicates the ambient temperature for which the equipment is able to operate.

DIMENSIONS

Please refer to the dimensions of your own appliance.

- *Models depth 600*

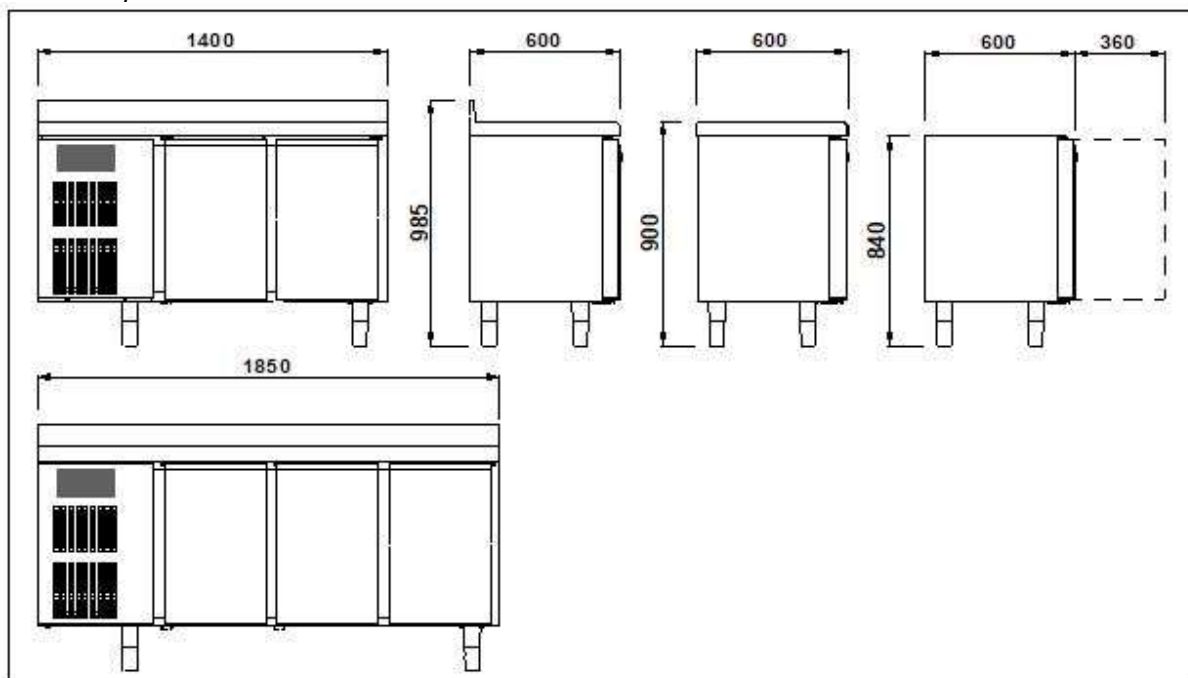

- *Models depth 700*

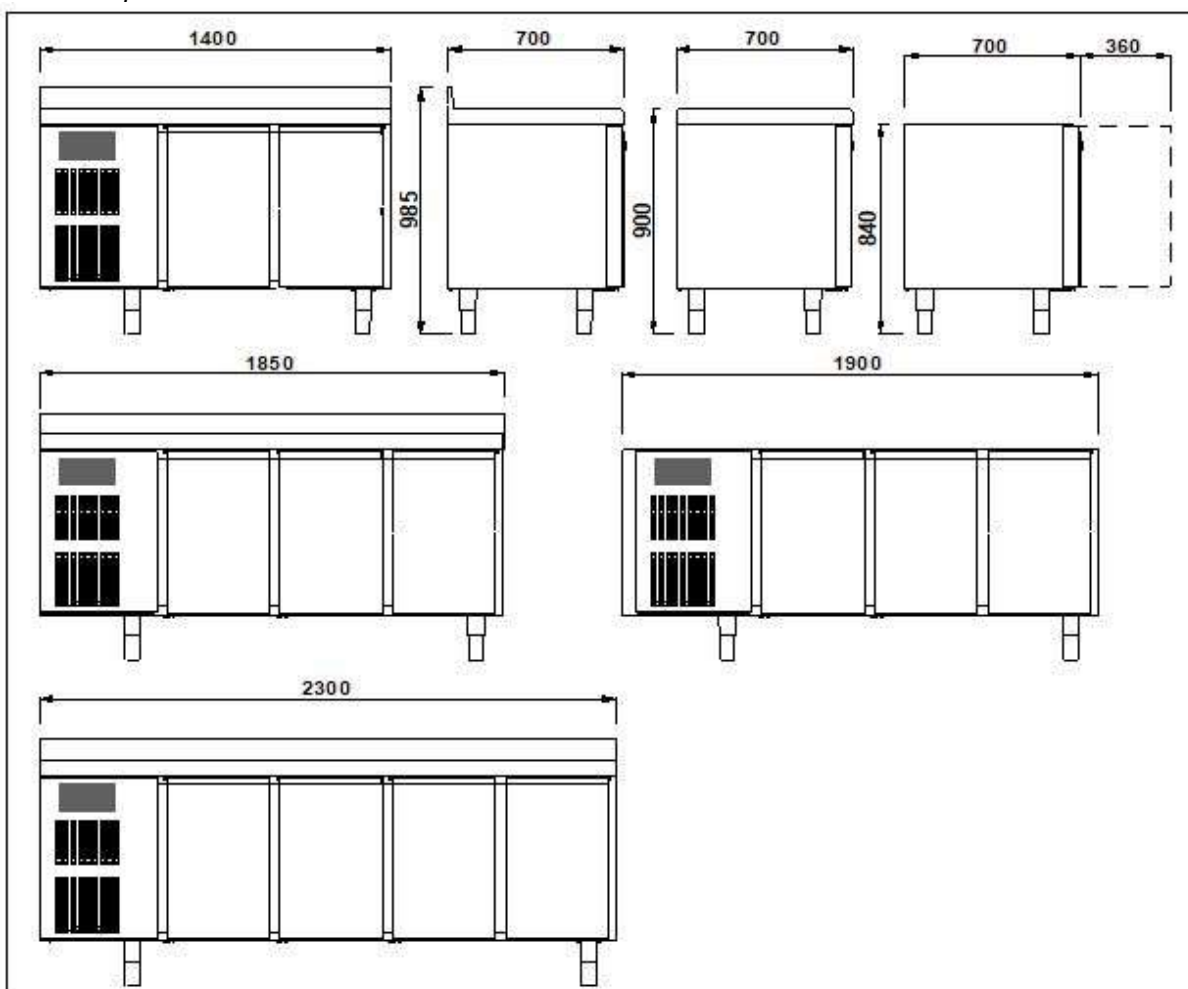

- *Models snack*

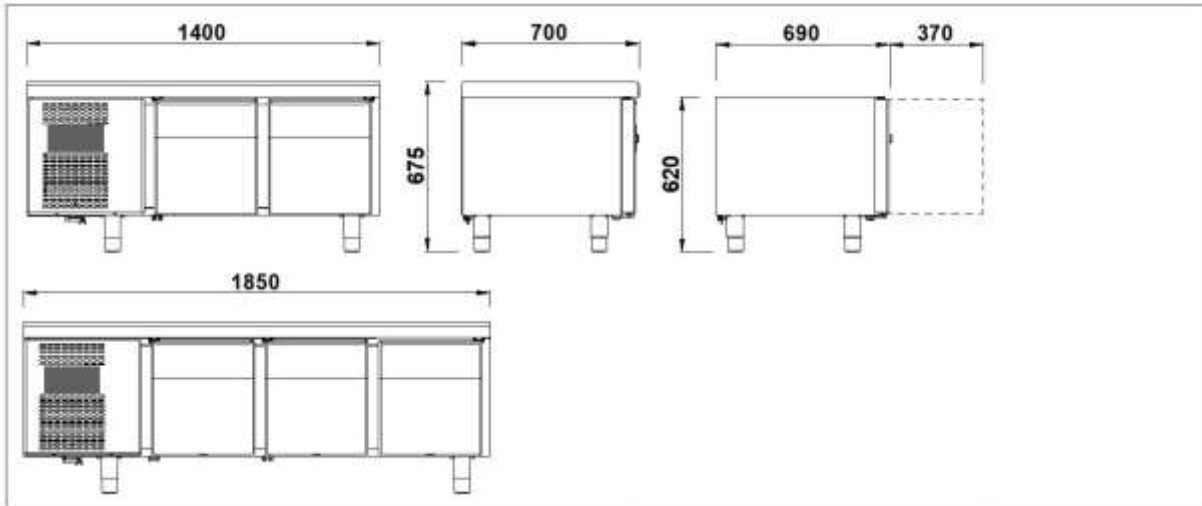

- *Models pastry & bakery*

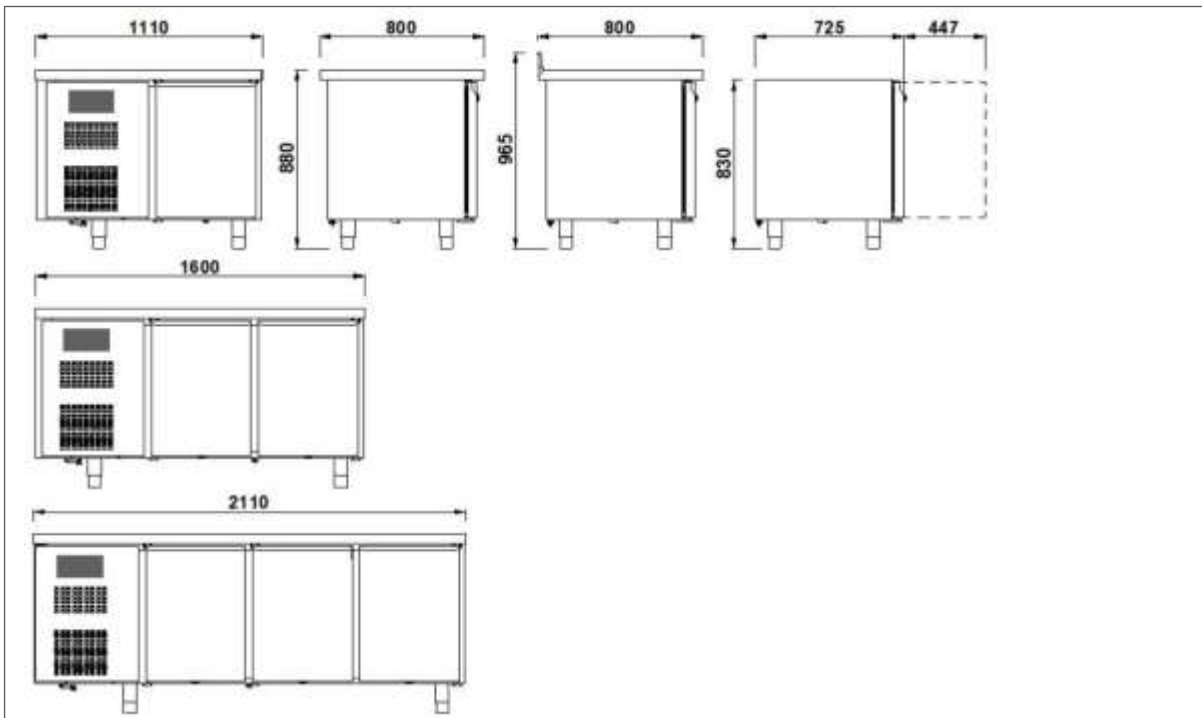

- *Models pizza*

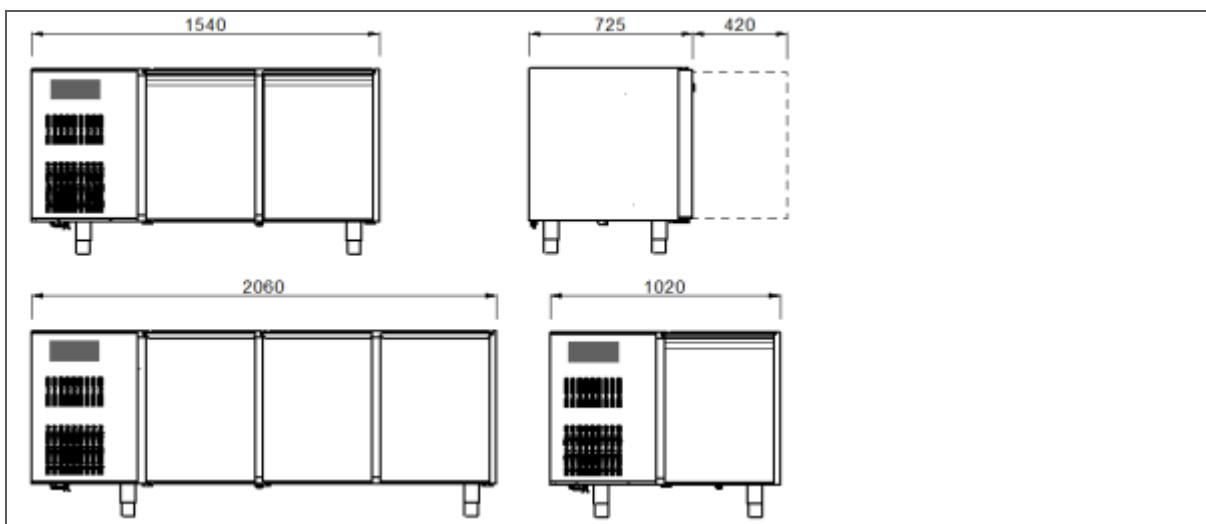

IMPLEMENTATION AND INSTALLATION

The products are always packed with cardboard and shipped on pallets.

In case of damage or missing parts upon delivery, follow the instructions given in the chapter 'GENERAL INFORMATION UPON DELIVERY'.

All setting up and starting operations are to be carried out by skilled staff.



Remove the packing with care in order not to dent the counter surfaces.

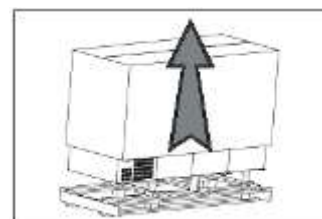

WARNING: keep the packing components (plastic bags, polystyrene foam, nails, etc) away from children since they can be very dangerous.

Use a fork truck to lift the counter and move it to the installation site, paying attention not to unbalance the load.

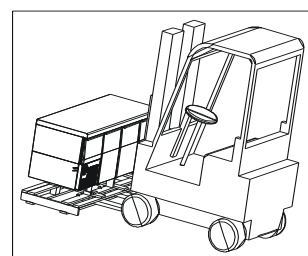

WARNING: do not push or drag the counter during installation or in the future, in order to prevent it from turning over or damaging its parts.

WARNING: Do not place the cabinet in the vicinity of heat/ignition sources or in environments with high temperatures and/or highly flammable materials.

Set unit in its final location.

Be sure there is adequate ventilation in your room. Do not allocate equipment to environments above the declared climate class.



Remove protective film from product.

This may cause unpleasant static electricity discharge which, however, is not dangerous.

The inconvenience is reduced or prevented by continuously holding the appliance with one hand or grounding the package.

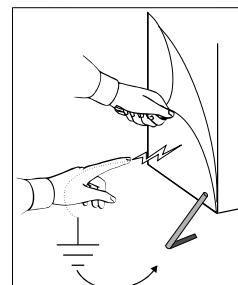

It is now possible to level the counter by adjusting its feet.

During leveling, slightly tilt the counter towards its back to allow for a better door closing.

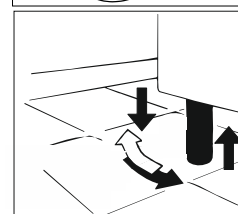

Clean with lukewarm water and mild detergent (as described in the chapter 'CLEANING') and assemble the accessories available.

Check the correspondence of the mains voltage with the one indicated in the identification plate of the counter.

WARNING: check that the mains outlet is provided with grounding. If not, arrange it.

Insert the plug into the outlet.

The counter must be incorporated into an equipotential system that must be checked for efficiency according to the regulations in force. The connection must be carried out by means of a screw marked as 'Equipotential' located in the compressor area.

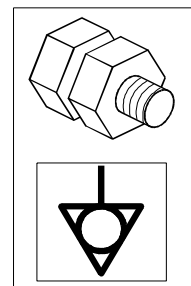

The installation is now completed.

GENERAL CLEANING AND MAINTENANCE

For a constant efficiency of the appliance it is recommended to perform the cleaning and maintenance operations.

Before to begin with the operations proceed as following:

- set the general cut-out in OFF position
- remove the plug from the socket and wait till the complete defrosting of the appliance.

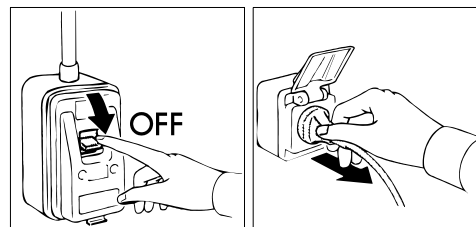

Clean the refrigerating group and the finned evaporator, using a vacuum cleaner or a non-metallic brush.

WARNING: the cleaning and maintenance operations of the refrigerating unit and the compressor area require the intervention of qualified personnel and cannot be carried out by unspecialized staff.

Clean the external and internal surfaces with water and neutral soap or detergent; a little vinegar in the water will remove eventual bad smells.

Rinse abundantly with pure water and dry up accurately.

The cleaning and maintenance operations have now come to end.

MAINTENANCE CABINETS STAINLESS STEEL

DAILY CLEANING

To guarantee a perfect hygiene and conservation of the appliance cabinet it is recommended to carry out often and/or daily the cleaning operations as indicated hereunder:

1. Clean carefully the appliance surfaces, only in the direction of the etching, with a soft wrung out sponge drenched with water and neutral detergent.
2. The detergents must not contain chlorine and must not be abrasive.
 - 2.a The kind of detergents recommended are the ones indicated hereunder:
 - Composite action disinfecting detergent; (containing non-ionic surfactants, benzalkonium chloride, chelating agents and pH buffer)
 - Laboratory, neutral detergent for hand washing; (containing anionic and non-ionic surfactants)
 - Food environments degreasant; (containing anionic surfactants and EDTA)

3. Before using the detergents, dilute them, if needed, following the instructions on the label.
4. Leave the detergents act for at least 5 minutes.
5. Rinse carefully the fridge walls with a sponge drenched in running water.
6. Dry carefully using a clean sponge.

WARNING: absolutely do not use utensils or materials which could cause cuts and consequently rust formations.

FOOD STAINS AND HARDENED RESIDUES

In case there are food or waste stains in the fridge, wash the surfaces with water and clean them off before they might harden.

If the wastes have already hardened, please follow the instructions hereunder:

1. Use a soft sponge drenched with lukewarm water and neutral detergent (you can use the detergents for the daily cleaning operations, at the highest concentration estimated by the label).
2. Dampen the hardened waste so as to maintain it damp for at least 30 minutes passing on it every five minutes the sponge drenched with water and detergents on the hardened dirty area.
3. At the end of this soaking operation remove the waste with the sponge drenched with water and neutral detergents.
4. If needed, use a wooden spatula or a fine stainless-steel sponge, taking care of not damaging the fridge surface.
5. At the end of this process it is recommended a daily cleaning operation cycle of all the internal surfaces of the fridge.
6. When the cleaning operations are over, rinse carefully with a sponge drenched with running water.
7. Dry carefully using a clean sponge.

The space around and under the refrigerator must also be cleaned and held in perfect hygiene. Clean using water and neutral soap or detergent.

Protect the sheet metal parts with silicon wax.

USEFULL ADVICES FOR THE CARE OF THE STAINLESS STEEL

For the cleaning and maintenance of the parts of stainless steel follow the advices written below, bearing in mind that the first and fundamental rule is to guarantee the non toxicity and best hygiene of the dealt products.

The stainless steel has a thin oxide coat that prevents rust formation.

But there are substances or detergents that can destroy this coat and give origin to corrosions.

Before using any detergent product ask always your dealer about which neutral detergent is the most qualified and does not cause corrosions on the steel.

In case of scratches on the surfaces it is necessary to smooth them using thin STAINLESS STEEL wool or an abrasive sponge in synthetic fibrous material, wiping in the direction of the satin.

WARNING: for the cleaning of the STAINLESS STEEL never use iron wool and never let them rest on the surfaces because little iron deposits could remain on the surfaces and cause rust formations by contamination and endanger the hygiene.

MAINTENANCE CABINETS VX-PET

To guarantee a perfect hygiene and conservation of the appliance it is recommended to carry out often and/or daily the cleaning operations.

Any food stains or residue on the outside surface should be removed with water before they harden. Remove any hardened food residue with a soft sponge dipped in oil of turpentine or denatured alcohol.

Any food stains or residue on the inside surface should be removed with a soft cloth and hot white vinegar or denatured alcohol.
Clean respecting the satinizing direction.

Daily cleaning of all inside surfaces of the appliance is recommended.

Do not use any abrasive paste or steel wool, acetone, trichloroethylene or ammonia.

When the cleaning operations are over, rinse carefully with a sponge drenched with running water.

Dry carefully using a clean sponge.

The space around and under the refrigerator must also be cleaned and held in perfect hygiene.
Clean using water and neutral soap or detergent.

WASTE DISPOSAL AND DEMOLITION

WASTE STORAGE

At the end of the product life, avoid release to the environment. The doors should be removed before disposal.

Temporary storage of special waste is permitted while waiting for disposal by treatment and/or final collection. Dispose of special waste in accordance with the laws in force with regard to protection of the environment in the country of the user.

PROCEDURE FOR ROUGH DISMANTLING THE APPLIANCE

All countries have different legislation; provision laid down by the laws and the authorised bodies of the countries where the demolition takes place are therefore to be observed.

A general rule is to deliver the appliance to specialised collection and demolition centres. Dismantle the refrigerator grouping together the components according to their chemical nature. The compressor contains lubricating oil and refrigerant, which may be recycled. The refrigerator components are considered special waste, which can be assimilated with domestic waste.

Make the appliance totally unusable by removing the power cable and any door locking mechanisms in order to avoid the risk of anyone being trapped inside.

DISMANTLING OPERATIONS SHOULD BE CARRIED OUT BY QUALIFIED PERSONNEL.

THE SAFE DISPOSAL OF WASTE FROM ELECTRICAL AND ELECTRONIC EQUIPMENT (WEEE DIRECTIVE 2002/96/EC)

Do not dump pollutant material in the environment. Dispose of it in compliance with the relevant laws.

Under the WEEE (Waste Electrical and Electronic Equipment) Directive 2002/96/EC, when scrapping equipment the user must dispose of it at the specific authorised disposal centres, or reassign it, still installed, to the original seller on purchase of new equipment.

All equipment which must be disposed of in accordance with the WEEE Directive 2002/96/EC is marked with

a special symbol .

The improper disposal of Waste Electrical and Electronic Equipment is liable to punishment under the relevant laws in the countries where the offence is committed.

Waste electrical and Electronic Equipment may contain hazardous substances with potential harmful effects on the environment and human health. You are urged to dispose of them properly.

GENERAL NOTES BY THE DELIVERY

At the delivery inspect that the packing is not injured and that it has not been damaged during the transport.

After having unpacked the refrigerator verify that all the parts are present and that the characteristics and the condition correspond to the order specifications.

Otherwise contact immediately the retailer.

We congratulate you on your choice and we hope that you can use our refrigerating cabinets to their utmost, by following the necessary instructions and precautions contained in this manual.

But, remember that any reproduction of this manual is forbidden and that due to a constant pursuit of innovation and technological quality, the features hereby presented could change without notice.

ACCESSORIES

The appliance can be equipped with the following accessories on request (*see "general catalogue"*).

HACCP REGULATIONS

WARNING: Raw vegetables, eggs and poultry **CANNOT** be kept in the same refrigerated place. Poultry must be kept in the proper refrigerated place.

WARNING: Avoid preserving food with a temperature between 10°C and 60°C. Make use of the proper appliances (blast chillers) to reduce the temperature to the core of the food.

WARNING: When taking the foodstuffs out of the refrigerator, check the expiry date marked on the package, and take out those with the nearest expiry date. If you note an expired food, it has to be kept away from the appliance and eliminated, reporting what happened to the person in charge of the firm where you work.

WARNING: Easily perishable foodstuffs must be taken out of the appliance ambient as late as possible in order to be exposed to room temperature only the necessary time.

WARNING: Do not refreeze foodstuffs previously defrosted.

WARNING: Number the equipment and check twice a day the temperature taken by recording the figures on a proper sheet to be kept for 24 months.

WARNING: Any interruption of current to the appliance can be carried out by checking the downtime with an electric clock in order to eliminate the foodstuffs that could perish.

Maximum temperatures admitted for goods

Foodstuff	Normal storage temperature (°C)	Maximum temperature of carriage (°C)
Fresh pasteurized milk	0÷+4	9
Fresh cream	0÷+4	9
Yoghurt, ricotta, fresh cheese	0÷+2	9
Frozen fish	0÷+2	0÷+4
Beef and pork	0÷+3	10
Poultry	0÷+4	8
Rabbit	0÷+2	8
Ground-game	0÷+2	8
Big game	0÷+2	8
Offal	0÷+3	8
Frozen food	-23÷-24	-18
Packed ice-cream	-18÷-20	-18
Fruit and vegetables	0÷+4	room temperature

TECHNICAL SPECIFICATIONS

Last page on the handbook: technical specifications.

CONTROL PANNELS

All products in the range use control panels with the following controls:

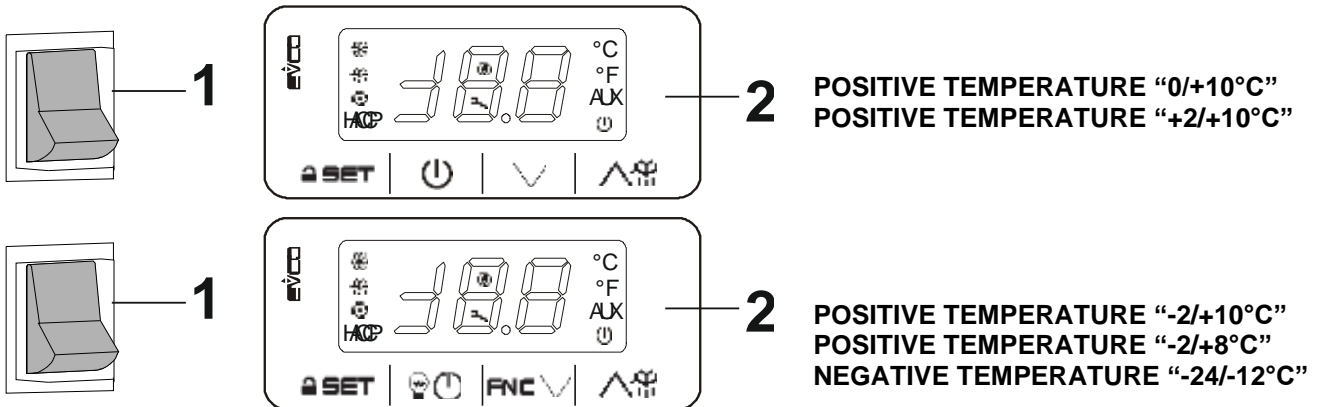

STARTING AND WORKING

To start operation, follow this procedure:

- Insert the plug into the current tap;
- position the line switch on ON;
- push the main switch (1);
now set the operating temperature with the thermoregulator (2).

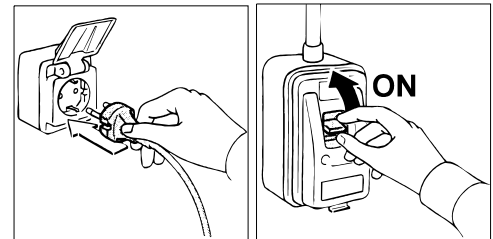

Check on the thermoregulator display (2) that the internal temperature of the counter corresponds to the set value.

LOCKING/UNLOCKING THE KEYBOARD

To lock the keyboard proceed as follows:

- Make sure no procedure is in progress
- Do not operate for 30 s: the display will show the message "Loc" for 1 s and the keyboard shall lock automatically.

If the keyboard is locked, you will not be allowed to:

- show the evaporator temperature
- activate the defrost by hand
- modify the working setpoint

These operations provoke the visualization of the label "Loc" 1 s.

To unlock the keyboard:

- Touch a key for 1 s: the display will show the message "UnL" for 1 s.

WORKING SETPOINT AND CONFIGURATION PARAMETERS

POSITIVE TEMPERATURE "0/+10°C" "+2/+10°C"

Setting the working setpoint

- Make sure that the keyboard is not locked and that no procedure is in progress
- Touch the **SET** key: the LED will flash
- Touch the \wedge or \vee key within 15 s; see also r1 and r2 parameters
- Touch the **SET** key or do not operate for 15 s: the LED will switch off after which, the device will exit the procedure.

To exit the procedure before the operation is complete:

- Touch the \square (any changes will not be saved)

The working setpoint can also be set via **SP** parameter.

Working setpoints

LABEL	MIN.	MAS.	U.M.	WORKING SETPOINT
r1	r2		°C/°F (1)	working setpoint; see also r0 and r12

Setting the configuration parameters

To access the procedure:

- Make sure no procedure is in progress
- Touch the **SET** key for 4 s: the display will show "PA"
- Touch the **SET** key
- Touch the \wedge or \vee key within 15 s to set the value determined with the "PAS" parameter (the parameter is set at "-19" by default)
- Touch the **SET** or do not operate for 15 s: the display will show "SP"

To select a parameter:

- Touch the \wedge or \vee key

To set a parameter:

- Touch the **SET** key
- Touch the \wedge or \vee key within 15 s.
- Touch the **SET** key or do not operate for 15 s.

To exit the procedure:

- Touch the **SET** key for 4 s or do not operate for 60 s (any changes will be saved)

Parametri di configurazione

LABEL	MIN.	MAS.	U.M.	WORKING SETPOINT
SP	r1	r2	°C/°F (1)	working setpoint; see also r0 and r12

LABEL	MIN.	MAS.	U.M.	ANALOG INPUTS
CA1	-25	25	°C/°F (1)	room probe offset
CA2	-25	25	°C/°F (1)	if P4 = 1, evaporator probe offset if P4 = 2, condenser probe offset
P0	0	1	-	probe type (0 = PTC; 1 = NTC)
P1	0	1	-	degree Celsius decimal point (during normal operation) 1 = YES
P2	0	1	-	unit of measurement for temperature (2) 0 = °C (Celsius degree; resolution depends on P1 parameter) 1 = °F (Fahrenheit degree; resolution is 1 °F)
P4	0	2	-	second input function 0 = digital input (door switch or multifunction) 1 = analog input (evaporator probe) 2 = analog input (condenser probe)
P5	0	2	-	magnitude displayed during normal operation 0 = room temperature 1 = working setpoint 2 = if P4 = 0, "- -" if P4 = 1, evaporator temperature if P4 = 2, condenser temperature
P8	0	250	0,1s	delayed display of temperature changes as detected by the probes

LABEL	MIN.	MAS.	U.M.	MAIN REGULATOR
r0	0.1	15	°C/°F (1)	working setpoint differential; see also r12
r1	-99	r2	°C/°F (1)	minimum working setpoint
r2	r1	99	°C/°F (1)	maximum working setpoint
r4	0	99	°C/°F (1)	working setpoint increase during the "energy saving" function; see also i0, i10 and HE2
r5	0	1	-	cooling or heating operation (3) 0 = cooling 1 = heating
r12	0	1	-	working setpoint differential type 0 = asymmetric 1 = symmetric

LABEL	MIN.	MAS.	U.M.	COMPRESSOR PROTECTION SYSTEM
C0	0	240	min	delay in switching on of compressor after the device switches on (4)
C2	0	240	min	minimum compressor switch-off duration (5)
C3	0	240	s	minimum duration of compressor switch on time
C4	0	240	min	duration of compressor switch off time during a room temperature probe error (code "Pr1"); see also C5
C5	0	240	min	duration of compressor switch on time during a room temperature probe error (code "Pr1"); see also C4
C6	0	199	°C/°F (1)	condenser temperature is higher than that at which the condenser overheating alarm is activated (code "COH") (6)
C7	0	199	°C/°F (1)	condenser temperature above which the compressor shut down alarm is activated (code "CSd")
C8	0	15	min	compressor shut down alarm delay (code "CSd") (7)

LABEL	MIN.	MAS.	U.M.	DEFROST
d0	0	99	h	if d8 = 0, 1 or 2, defrost interval 0 = interval defrost will never be activated if d8 = 3, maximum defrost interval
d2	-99	99	°C/°F (1)	evaporator temperature at end of defrost; see also d3
d3	0	99	min	if P4 = 0 or 2, defrost duration if P4 = 1, maximum defrost duration; see also d2 0 = defrost will not be activated
d4	0	1	-	defrost when device is switched on (4) 1 = YES
d5	0	99	min	if d4 = 0, minimum time between switching on of device and activation of defrost (4) if d4 = 1, delay in activation of defrost after device is switched on (4)
d6	0	2	-	temperature displayed during defrost (only if P5 = 0) 0 = room temperature 1 = if on activation of defrost, the room temperature is below the "work setpoint + Δt", at maximum "work setpoint + Δt"; if on activation of defrost, the room temperature is above "work setpoint + Δt", at maximum the room temperature on activation of defrost (8) (9) 2 = label "dEF"
d7	0	15	min	dripping duration (during dripping the compressor will remain switched off)
d8	0	3	-	defrost activation methods 0 = AT INTERVALS - FOR TIME - defrost will be activated once the device has altogether been running for time d0 1 = AT INTERVALS - FOR COMPRESSOR SWITCH-ON - defrost will be activated once the compressor has altogether been switched on for time d0 2 = AT INTERVALS - FOR EVAPORATOR TEMPERATURE - defrost will be activated when the evaporator temperature has remained below the temperature d9 for a total time of d0 (10) 3 = ADAPTIVE - defrost will be activated at intervals, whose duration will each time depend on the duration of compressor switch-ons, the evaporator temperature and the door switch input activation; see also d18, d19, d20, d22, i13 and i14 (10)
d9	-99	99	°C/°F (1)	evaporator temperature is higher than that at which the defrost interval counter is suspended (only if d8 = 2)
d11	0	1	-	defrost alarm switches off once maximum time limit has been reached (code "dFd"); only if P4 = 1 and in absence of evaporator probe error (code "Pr2") 1 = YES
d16	0	999	min	defrost interval (defrost will be activated when the compressor has been on totally, with the evaporator temperature below that of d22, for time d18; only if d8 = 3) 0 = defrost will never be activated due to the effect of this condition
d18	0	999	min	defrost interval (defrost will be activated when the compressor has been on totally, with the evap. temp. below that of d22, for time d18; only if d8 = 3) 0 = defrost will never be activated due to the effect of this condition
d19	0	40	°C/°F (1)	evaporator temperature below which the defrost is activated (relative to the evaporator temperatures average, or "evaporator temperatures average - d19"; only if d8 = 3)
d20	0	999	min	minimum consecutive time the compressor must be switched on such as to provoke the defrost activation 0 = defrost will never be activated due to the effect of this condition
d22	0	19,9	°C/°F (1)	evaporator temperature above which the defrost interval count shall be suspended (relating to the average of evaporator temperatures, that is to say, "evaporator temperatures average + d22"; only if d8 = 3); see also d18

LABEL	MIN.	MAS.	U.M.	TEMPERATURE ALARMS (11) (12)
A1	0	99	°C/°F (1)	room temperature below which the minimum temperature alarm is triggered (code "AL"; it concerns the working setpoint, that is to say, "working setpoint - A1"); see also A11 0 = alarm absent
A4	0	99	°C/°F (1)	room temperature above which the maximum temperature alarm is triggered (code "AH"; it concerns the working setpoint, that is to say, "working setpoint + A4"); see also A11 0 = alarm absent
A6	0	99	10 min	delay in maximum temperature alarm (code "AH") after the device is switched on (4)
A7	0	199	min	minimum temperature alarm delay (code "AL") and maximum temperature alarm delay (code "AH")
A11	0,1	15	°C/°F (1)	differential of A1 and A4 parameters

LABEL	MIN.	MAS.	U.M.	DIGITAL INPUTS
i0	0	4	-	effect caused by the activation of the digital input 0 = no effect 1 = DOOR SWITCH - DOOR SWITCH INPUT ALARM ACTIVATION (code "id") - the compressor will be switched off (at maximum for time i3 or until the input is deactivated); see also i2 (13) 2 = MULTIFUNCTION - ACTIVATION OF "ENERGY SAVING" FUNCTION - the "energy saving" function will be activated (just with effect on the compressor, until the input is deactivated); see also r4 3 = MULTIFUNCTION - ACTIVATION OF MULTIFUNCTION INPUT ALARM (code "iA") - the device will continue to operate normally; see also i2 4 = MULTIFUNCTION - ACTIVATION OF THE MAXIMUM PRESSURE SWITCH ALARM (code "iA") - the compressor will be switched off (until the input is deactivated); see also i2
i1	0	1	-	type of digital input contact 0 = normally open (active input with closed contact) 1 = normally closed (active input with open contact)

i2	-1	120	min	if i0 = 1, delay in signalling of door switch input alarm (code "id") -1 = the alarm will not be signalled if i0 = 3, delay in signalling of multifunction input alarm (code "iA") -1 = the alarm will not be signalled if i0 = 4, delay in switching on of compressor after the deactivation of the maximum pressure switch alarm (code "iA") -1 = reserved
i3	-1	120	min	maximum duration of the effect caused by the activation of the door switch input on the compressor -1 = the effect will last until the input is deactivated
i10	0	999	min	time that must pass in absence of door switch input activations (after the room temperature has reached the working setpoint) for the "energy saving" function to be activated; see also r4 and HE2 0 = the function will never be activated due to the effect of this condition
i13	0	240	-	number of door switch input activations such as to provoke the defrost activation 0 = defrost will never be activated due to the effect of this condition
i14	0	240	min	minimum duration of the door switch input activation such as to provoke the defrost activation 0 = defrost will never be activated due to the effect of this condition

LABEL	MIN.	MAS.	U.M.	ENERGY SAVING
HE2	0	99	min	maximum duration of the "energy saving" function activated due to the effect of absence of door switch input activation; see also r4 and i10 0 = the function will last until the input is activated
HE3	0	240	min	time interval with no key strokes, after which the "low consumption" function is activated 0 = the mode shall never be aac

LABEL	MIN.	MAS.	U.M.	VARIOUS
POF	0	1	-	key activation 1 = YES
PAS	-99	999	-	access password for the configuration parameters 0 = the password need not be set

- (1) the unit of measurement depends on P2
- (2) properly set the parameters corresponding to the regulators after setting P2 parameter
- (3) if r5 parameter is set at 1, the "energy saving" function and the defrost management will be switched off
- (4) the parameter has effect even after an interruption in the power supply that occurs while the device is switched on
- (5) the time set by parameter C2 is counted also when the device is off
- (6) the differential of parameter is 2.0°C/4°F
- (7) if when the device is switched on, the condenser temperature is already above that established in C7 parameter, then C8 parameter will not have effect
- (8) the value Δt depends on r12 parameter (r0 if r12 = 0, r0/2 if r12 = 1)
- (9) the display restores normal operation when, at the end of the dripping phase, room temperature falls below the value that locked the display (or if a temperature alarm is triggered)
- (10) if P4 parameter is set at 0 or 2, the device will function as if d8 parameter were set at 0
- (11) during defrost and dripping, the maximum temperature alarm is absent, provided that it was triggered after defrost activation.
- (12) during activation of the door switch input, the maximum temperature alarm is absent, provided the alarm was signaled after the activation of the input
- (13) the compressor is switched off 10 s after the activation of the input

POSITIVE TEMPERATURE "-2/+10°C" "-2/+8°C" - NEGATIVE TEMPERATURE "-24/-12°C"

Setting the working setpoint

- Make sure that the keyboard is not locked and that no procedure is in progress
- Touch the **SET** key: the LED will flash
- Touch the or key within 15 s; see also r1 and r2 parameters
- Touch the **SET** key or do not operate for 15 s: the LED will switch off after which, the device will exit the procedure.

To exit the procedure before the operation is complete:

- Touch the (any changes will not be saved)

The working setpoint can also be set via **SP** parameter.

Working setpoints

LABEL	MIN.	MAS.	U.M.	WORKING SETPOINT
r1	r2		°C/°F	working setpoint; see also r0 and r12

Setting the configuration parameters

To access the procedure:

- Make sure no procedure is in progress
- Touch the **SET** key for 4 s: the display will show "PA"
- Touch the **SET**
- Touch the or key within 15 s to set the value determined with the "PAS" parameter (the parameter is set at "-19" by default)
- Touch the **SET** or do not operate for 15 s: the display will show "SP"

To select a parameter:

- Touch the or key

To set a parameter:

- Touch the **SET** key
- Touch the or key within 15 s.
- Touch the **SET** key or do not operate for 15 s.

To exit the procedure:

- Touch the **SET** key for 4 s or do not operate for 60 s (any changes will be saved)

Configuration parameters

LABEL	MIN.	MAS.	U.M.	WORKING SETPOINT
SP	r1	r2	°C/°F	working setpoint; see also r0 and r12

LABEL	MIN.	MAS.	U.M.	ANALOGUE INPUTS
CA1	-25	25	°C/°F	cabinet probe offset if P4 = 3, air in probe offset
CA2	-25	25	°C/°F	evaporator probe offset
CA3	-25	25	°C/°F	auxiliary probe offset
P0	0	1	-	probe type 0=PTC 1=NTC
P1	0	1	-	enable °C decimal point 0 = no 1 = yes
P2	0	1	-	temperature unit of measurement 0 = °C 1 = °F
P3	0	2	-	evaporator probe function 0 = disabled 1 = defrost + fan 2 = fan
P4	0	3	-	configurable input function 0 = digital input 1 = condenser probe 2 = critical temperature probe 3 = air out probe if P4 = 3, regulation temperature = product temperature (CPT)
P5	0	4	-	value displayed 0 = regulation temperature 1 = setpoint 2 = evaporator temperature 3 = auxiliary temperature 4 = air in temperature
P7	0	100	%	air in weight for calculated product temperature (CPT) $CPT = \{[(P7 \times \text{air in})] + [(100 - P7) \times \text{air out}]: 100\}$
P8	0	250	0,1 s	display refresh time

LABEL	MIN.	MAS.	U.M.	REGULATION
r0	0.1	15	°C/°F	setpoint differential
r1	-99	r2	°C/°F	minimum setpoint
r2	r1	99	°C/°F	maximum setpoint
r4	0	99	°C/°F	setpoint offset in energy saving
r5	0	1	-	cooling or heating operation 0 = cooling 1 = heating
r6	0	99	°C/°F	setpoint offset in overcooling/overheating
r7	0	240	min	overcooling/overheating duration
r8	0	2	-	DOWN key additional function 0 = disabled 1 = overcooling/overheating 2 = energy saving
r12	0	1	-	position of the r0 differential 0 = asymmetric 1 = symmetric

LABEL	MIN.	MAS.	U.M.	COMPRESSOR
C0	0	240	min	compressor on delay after power-on
C2	0	240	min	compressor off minimum time
C3	0	240	s	compressor on minimum time
C4	0	240	min	compressor off time during cabinet probe alarm
C5	0	240	min	compressor on time during cabinet probe alarm
C6	0	200	°C/°F	threshold for high condensation warning
C7	0	200	°C/°F	threshold for high condensation alarm
C8	0	15	min	high condensation alarm delay
C10	0	9999	h	compressor hours for service 0 = disabled
C11	0	240	s	second compressor switch-on delay
C12	0	10	-	number of start-ups for compressor rotation 0 = disabled

LABEL	MIN.	MAS.	U.M.	DEFROST
d00	0	1	-	enable parameters type b 0 = no 1 = yes
d01	r1	r2	°C/°F	setpoint threshold to enable parameters type b if SP > d01
d0	0	99	h	automatic defrost interval 0 = only manual if d8 = 3, maximum interval
d0b	0	99	h	automatic defrost interval 0 = only manual

				if d8 = 3, maximum interval
d1	0	2	-	defrost type 0 = electric 1 = hot gas 2 = compressor stopped
d1b	0	2	-	defrost type 0 = electric 1 = hot gas 2 = compressor stopped
d2	-99	99	°C/°F	threshold for defrost end
d2b	-99	99	°C/°F	threshold for defrost end
d3	0	99	min	defrost duration if P3 = 1, maximum duration
d3b	0	99	min	defrost duration if P3 = 1, maximum duration
d4	0	1	-	enable defrost at power-on 0 = no 1 = yes
d5	0	99	min	defrost delay after power-on
d6	0	2	-	value displayed during defrost 0 = regulation temperature 1 = display locked 2 = dEF label
d7	0	15	min	dripping time
d7b	0	15	min	dripping time
d8	0	3	-	defrost interval counting mode 0 = device on hours 1 = compressor on hours 2 = hours evaporator temperature < d9 3 = adaptive 4 = real time
d9	-99	99	°C/°F	evaporation threshold for automatic defrost interval counting
d11	0	1	-	enable defrost timeout alarm 0 = no 1 = yes if d1 = 0 or 1, enabled with SP < 0, if d1 = 2, disabled
d15	0	99	min	compressor on consecutive time for hot gas defrost
d16	0	99	min	pre-dripping time for hot gas defrost
d18	0	999	min	adaptive defrost interval if compressor on + evaporator temperature < d22 0 = only manual
d19	0	40	°C/°F	threshold for adaptive defrost (relative to optimal evaporation temperature) optimal evaporation temperature - d19
d20	0	999	min	compressor on consecutive time for defrost 0 = disabled
d21	0	500	min	compressor on consecutive time for defrost after power-on and overcooling if (regulation temperature - setpoint) > 10°C/20 °F 0 = disabled
d22	0	10	°C/°F	evaporation threshold for adaptive defrost interval counting (relative to optimal evaporation temperature) optimal evaporation temperature + d22

LABEL	MIN.	MAS.	U.M.	ALARMS
AA	0	2	-	select value for high/low temperature alarms 0 = regulation temperature 1 = evaporator temperature 2 = auxiliary temperature
A1	0	99	°C/°F	threshold for low temperature alarm
A2	0	2	-	low temperature alarm type 0 = disabled 1 = relative to setpoint 2 = absolute
A4	0	99	°C/°F	threshold for high temperature alarm
A5	0	2	-	high temperature alarm type 0 = disabled 1 = relative to setpoint 2 = absolute
A6	0	99	10 min	high temperature alarm delay after power-on
A7	0	240	min	high/low temperature alarms delay
A8	0	240	min	high temperature alarm delay after defrost
A9	0	240	min	high temperature alarm delay after door closing
A10	0	240	min	power failure duration for alarm recording
A11	0,1	15	°C/°F	high/low temperature alarms reset differential

LABEL	MIN.	MAS.	U.M.	FANS
F0	0	4	-	evaporator fan mode during normal operation 0 = off 1 = on 2 = according to F15 and F16 if compressor off, on if compressor on 3 = thermoregulated (with F1 and F1A) 4 = thermoregulated (with F1 and F1A) if compressor on
F0b	0	4	-	evaporator fan mode during normal operation 0 = off 1 = on 2 = according to F15 and F16 if compressor off, on if compressor on 3 = thermoregulated (with F1 and F1A) 4 = thermoregulated (with F1 and F1A) if compressor on
F1	-99	99	°C/°F	threshold for evaporator fan off

F1A	-99	99	°C/°F	threshold for evaporator fan on if F1A > F1, F1 differential = 2 °C/4 °F
F2	0	2	-	evaporator fan mode during defrost and dripping 0 = off 1 = on 2 = according to F0
F2b	0	2	-	evaporator fan mode during defrost and dripping 0 = off 1 = on 2 = according to F0
F3	0	15	min	evaporator fan off maximum time
F3b	0	15	min	evaporator fan off maximum time
F4	0	240	10 s	evaporator fan off time during energy saving
F5	0	240	10 s	evaporator fan on time during energy saving
F7	-99	99	°C/°F	threshold for evaporator fan on after dripping (relative to setpoint) setpoint + F7
F9	0	240	s	evaporator fan off delay after compressor off
F10	0	99	°C/°F	difference "cabinet temperature - evaporator temperature" for evaporator fan on differential = 2 °C/4 °F
F11	0	99	°C/°F	threshold for condenser fan on
F12	0	240	s	condenser fan off delay after compressor off
F13	0	15	°C/°F	differential F11
F15	0	240	s	evaporator fan off time with compressor off if F0 = 2
F16	0	240	s	evaporator fan on time with compressor off if F0 = 2

LABEL	MIN.	MAS.	U.M.	DIGITAL INPUTS
i0	0	5	-	door switch input function 0 = disabled 1 = compressor + evaporator fan off 2 = evaporator fan off 3 = cabinet light on 4 = compressor + evaporator fan off, cabinet light on 5 = evaporator fan off + cabinet light on
i1	0	1	-	door switch input activation 0 = with contact closed 1 = with contact open
i2	-1	120	min	open door alarm delay -1 = disabled
i3	-1	120	min	regulation inhibition maximum time with door open -1 = until the closing
i5	0	7	-	door switch/multi-purpose input function 0 = disabled 1 = energy saving 2 = iA alarm 3 = button-operated load on 4 = device on/off 5 = Cth alarm 6 = th alarm 7 = compressor + evaporator fan off, cabinet light on 8 = evaporator fan off + cabinet light on
i6	0	1	-	door switch/multi-purpose input activation 0 = with contact closed 1 = with contact open
i7	0	120	min	multi-purpose input alarm delay -1 = disabled if i5 = 5 or 6, compressor on delay after alarm reset
i10	0	999	min	door closed consecutive time for energy saving after regulation temperature < SP 0 = disabled
i13	0	240	-	number of door openings for defrost 0 = disabled
i14	0	240	min	door open consecutive time for defrost 0 = disabled

LABEL	MIN.	MAS.	U.M.	DIGITAL OUTPUTS
uc1	0	12	-	relay K1 configuration 0 = compressor 1 = defrost 2 = evaporator fan 3 = cabinet light 4 = demisting 5 = button-operated load 6 = alarm 7 = door heaters 8 = heater for neutral zone 9 = condenser fan 10 = on/stand-by 11 = compressor 2 12 = disabled
uc2	0	12	-	relay K2 configuration (like uc1)
uc3	0	12	-	relay K3 configuration (like uc2)
uc4	0	12	-	relay K4 configuration (like uc3)
u2	0	1	-	enable cabinet light and buttonoperated load in stand-by 0 = no

				1 = yes manual
u4	0	1	-	enable alarm output off silencing the buzzer 0 = no 1 = yes
u5	-99	99	°C/°F	threshold for door heaters on differential = 2 °C/4 °F
u6	0	120	min	demisting on duration 0 = manual
u7	-99	99	°C/°F	neutral zone threshold for heating (relative to setpoint) setpoint + u7
u8	1	15	°C/°F	u7 differential

LABEL	MIN.	MAS.	U.M.	ENERGY SAVING (if r5 = 0)
HE2	0	999	min	energy saving maximum duration -1 = until the door opening

LABEL	MIN.	MAS.	U.M.	REAL TIME ENERGY SAVING (if r5 = 0)
H01	0	23	h	Daily energy saving time
H02	0	24		Daily energy saving maximum duration

LABEL	MIN.	MAS.	U.M.	REAL TIME DEFROST (if d8 = 4)
Hd1	-	-	-	1st daily defrost time h= disabled
Hd2	-	-	-	2st daily defrost time h= disabled
Hd3	-	-	-	3st daily defrost time h= disabled
Hd4	-	-	-	4st daily defrost time h= disabled
Hd5	-	-	-	5st daily defrost time h= disabled
Hd6	-	-	-	6st daily defrost time h= disabled

LABEL	MIN.	MAS.	U.M.	SAFETIES
Pbu	0	2	-	selecting the event for buzzer activation 0 = disabled 1 = alarms 2 = keys and alarms
POF	0	1	-	enable ON/STAND-BY key 0 = no 1 = yes
PAS	-99	999	-	password
PA1	-99	999	-	level 1 password
PA2	-99	999	-	level 2 password





LABEL	MIN.	MAS.	U.M.	REAL TIME CLOCK
POF	0	1	-	enable clock 0 = no 1 = yes

LABEL	MIN.	MAS.	U.M.	DATA-LOGGING EVLINK
bLE	0	99	-	enable Bluetooth 0 = free 1 = forced for EVconnect or EPoCA 2... 99 = EPoCA local network address
rE0	0	240	min	data-logger sampling interval
rE1	0	5	-	recorded temperature 0 = none 1 = cabinet 2 = evaporator 3 = auxiliary 4 = cabinet and evaporator 5 = all

LABEL	MIN.	MAS.	U.M.	MODBUS
LA	1	247	-	MODBUS address
Lb	0	3	-	MODBUS baud rate 0 = 2,400 baud 1 = 4,800 baud 2 = 9,600 baud 3 = 19,200 baud parity even

HUMIDITY MANAGEMENT (only on appliances Pastry & Bakery)





It is possible to regulate the value of humidity required depending from the goods that have to be stored:

- Make sure that the keyboard is not locked and that no procedure is in progress
- Touch the **FNC**  key within 2 s: the display will display the label relative to the humidity setting (rH⁺ = high humidity or rH⁻ = low humidity)
- Touch the **SET**  key within 2 s to change the setting
- Touch the   key for confirm and exit the procedure.

ALARMS AND SIGNALS

POSITIVE TEMPERATURE “0/+10°C” “+2/+10°C”

Signals

LED	MEANING
	Compressor LED If the LED is on, the compressor is on If the LED is flashing: - the working setpoint is in the process of being set - a compressor protection will be in progress
	Defrost LED If the LED is on, defrost is in progress If the LED is flashing, dripping will be in progress
	Energy saving LED If the LED is on and the display is switched on, the "energy saving" function is in progress If the LED is on and the display is switched off, the "low consumption" function is in progress; touch a key to restore normal display
°C	Celsius degrees LED If the LED is on, the unit of measurement for temperature is Celsius degrees
°F	Fahrenheit degrees LED If the LED is on, the unit of measurement for temperature is Fahrenheit degrees
	LED on/stand-by If the LED is on, the device is switched off

Signals

CODE	MEANING
Loc	the keyboard is blocked
- - -	the operation requested is not available
dEF	defrost is in progress

Alarms

CODE	MEANING
AL	Minimum temperature alarm in the compartment Solutions: - check the room temperature; see A1 parameter Main consequences: - the device will continue to operate normally
AH	Maximum temperature alarm in the compartment Solutions: - check the room temperature; see A4 parameter Main consequences: - the device will continue to operate normally
id	Door switch input alarm Solutions: - check the causes of the activation of the input; see i0 and i1 parameters Main consequences: - the effect established with the i0 parameter
dFd	Defrost alarm switched off because maximum time has been reached Solutions: - check the integrity of the evaporator probe; see d2, d3 and d11 parameters

	<ul style="list-style-type: none"> - touch a key to restore normal display <p>Main consequences:</p> <ul style="list-style-type: none"> - the device will continue to operate normally
--	--

When the cause of the alarm disappears, the device restores normal operation, except for the following alarms:

- compressor shut down alarm (code "CSd") which requires the switching off of the device or the temporary suspension of the power supply.
- defrost alarm switched off because maximum time has been reached (code "dFd") which requires the touching of a key







Errors

CODE	MEANING
Pr1	<p>Room temperature probe error</p> <p>Solutions:</p> <ul style="list-style-type: none"> - check that the probe is the PTC or NTC type; see P0 parameter - check the device-probe connection - check room temperature <p>Main consequences:</p> <ul style="list-style-type: none"> - compressor activity will depend on C4 and C5 parameters - the defrost will not be activated
Pr2	<p>Evaporator/defrost probe error</p> <p>Solutions:</p> <ul style="list-style-type: none"> - the same as in the previous example, but with regard to the evaporator probe or the condenser probe <p>Main consequences:</p> <ul style="list-style-type: none"> - if P4 parameter is set at 1, the defrost interval will last for the amount of time set with d3 parameter - if P4 parameter is set at 1 and d8 parameter is set at 2 or to 3, the device will operate as if d8 parameter were set at 0 - if P4 parameter is set at 2, the condenser overheated alarm (code "COH") will never be activated - if P4 parameter is set at 2, the compressor shut down alarm (code "CSd") will never be activated

When the cause of the error disappears, the device restores normal operation.

POSITIVE TEMPERATURE "-2/+10°C" "-2/+8°C" - NEGATIVE TEMPERATURE "-24/-12°C"

Signals

LED	MEANING
	<p>Compressor LED</p> <ul style="list-style-type: none"> - If the LED is on, the compressor is on - If the LED is flashing: <ul style="list-style-type: none"> - the working setpoint is in the process of being set - a compressor protection will be in progress
	<p>Defrost LED</p> <ul style="list-style-type: none"> - If the LED is on, defrost is in progress - pre-dripping is in progress <p>If the LED is flashing:</p> <ul style="list-style-type: none"> - defrost will be requested but a compressor protection will be in progress - dripping will be in progress - defrost will be requested but a compressor minimum switch-on shall be in progress
	<p>Evaporator fan LED</p> <ul style="list-style-type: none"> - If the LED is on the evaporator fan will be on - If the LED is flashing evaporator fan standstill will be in progress
HACCP	<p>Saved HACCP alarm in EVlink</p>
AUX	<p>Auxiliary LED</p> <ul style="list-style-type: none"> - If the LED is on: <ul style="list-style-type: none"> - the door resistances will be lit
	<p>Energy saving LED</p> <ul style="list-style-type: none"> - If the LED is on and the display is switched on, the "energy saving" function is in progress - If the LED is on and the display is switched off, the "low consumption" function is in progress; touch a key to restore normal display
	<p>Maintenance LED</p> <ul style="list-style-type: none"> - if it is on, the compressor must be maintained
°C	<p>Celsius degrees LED</p> <ul style="list-style-type: none"> - If the LED is on, the unit of measurement for temperature is Celsius degrees - If it is flashing, the "rapid cooling" or "rapid heating" function will be in progress
°F	<p>Fahrenheit degrees LED</p> <ul style="list-style-type: none"> - If the LED is on, the unit of measurement for temperature is Fahrenheit degrees - If it is flashing, the "rapid cooling" or "rapid heating" function will be in progress
	<p>LED on/stand-by</p> <ul style="list-style-type: none"> - If the LED is on, the device is switched off ("standby" status)

Signals

CODE	MEANING
Loc	the keyboard is blocked
- - -	the operation requested is not available

Alarms

CODE	MEANING
rtc	Clock alarm Solutions: set date, time and day of the week
AL	Minimum temperature alarm in the compartment Solutions: - check the room temperature or CPT temperature; see A1 parameter Main consequences: - the alarm output will be switched on
AH	Maximum temperature alarm in the compartment Solutions: - check the room temperature or CPT temperature; see A4 parameter Main consequences: - the alarm output will be switched on
id	Door switch input alarm Solutions: - check the causes of the activation of the input; see i0 and i1 parameters Main consequences: - the effect established with the i0 parameter - the alarm output will be switched on
PF	Power failure alarm Solutions: - touch a key - check electrical connection
dFd	Defrost alarm switched off because maximum time has been reached Solutions: - check the integrity of the evaporator probe; see d2, d3 and d11 parameters - touch a key to restore normal display Main consequences: - the device will continue to operate normally

When the cause of the alarm disappears, the device restores normal operation, except for the following alarms:

- the compressor blocked alarm (code "CSd") and the global thermal protection alarm (code "th"), which both need to be reset by turning the device off or switching off the power supply.
- defrost alarm switched off because maximum time has been reached (code "dFd") which requires the touching of a key.

Errors

CODE	MEANING
Pr1	Room temperature probe or inlet air probe error Solutions: - check that the probe is the PTC or NTC type; see P0 parameter - check the device-probe connection - check room temperature/CPT temperature Main consequences: - compressor activity will depend on C4 and C5 parameters - if the P4 parameter is set at 3, the temperature associated with the regulation and the temperature alarms shall be the outgoing air temperature - the defrost will not be activated - the alarm output will be switched on - the door heating elements shall be turned off - the neutral area operation heating elements will be turned off
Pr2	Evaporator/defrost probe error Solutions: - the same as in the previous example, but with regard to the evaporator probe Main consequences: - if P3 parameter is set at 1, the defrost interval will last for the amount of time set with d3 parameter - if P3 parameter is set at 1 and d8 parameter is set at 2 or to 3, the device will operate as if d8 parameter were set at 0 - if P3 parameter is set at 1 or 2 and F0 parameter is set at 3 to 4, the device will operate as if parameter were set at 2 - the alarm output will be switched on

When the cause of the error disappears, the device restores normal operation.

DEFROSTING

THE DEFROSTING OF THE REFRIGERATING CABINETS IS TOTALLY AUTOMATIC.

The air defrosting operation of the appliances at "POSITIVE TEMPERATURE $0/+10^{\circ}\text{C} \div +2/+10^{\circ}\text{C}$ " occurs automatically every 6 hours. The defrosting lasts 20 minutes.

The defrosting of the installations with "POSITIVE TEMPERATURE $-2/+10^{\circ}\text{C} \div -2/+8^{\circ}\text{C}$ " is with resistance and occurs automatically every 6 hours. The duration of the defrosting is automatically regulated by the refrigerator.

The defrosting of the installations with "NEGATIVE TEMPERATURE $-24/-12^{\circ}\text{C}$ " is hot gas and occurs automatically operated every 6 hours of the compressor. The duration of the defrosting is automatically regulated by the refrigerator.

A defrost cycle can be selected at any time by pressing button "▲❄"; for 5 seconds. The next automatic defrost cycle will start 6 hours after pressing the button for the installations with "POSITIVE TEMPERATURE" and 6 hours of the compressor operation after pressing the button for the installations with "NEGATIVE TEMPERATURE".

LOADING THE PRODUCT

- Distribute the product evenly inside the appliance compartments so as to allow adequate air circulation;
 - Do not obstruct the ventilation areas of the cooling system located on the left of the compartment;
 - Do not use the lower drawer on the right to store foodstuffs requiring low-temperature storing;
 - Cover or wrap foodstuffs with specific protective films before storing;
 - Do not introduce hot foodstuffs or beverages;
 - Do not leave the door open longer than is necessary when introducing or removing products;
 - Only load the top shelf up to the stacking mark;
 - Do not place products below the bottom shelf support.
- *Snack models*: only load lower drawers up to the stacking mark.

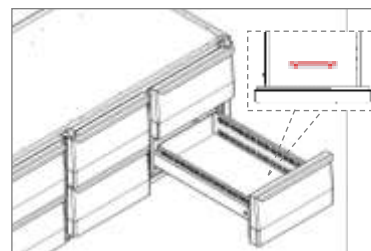
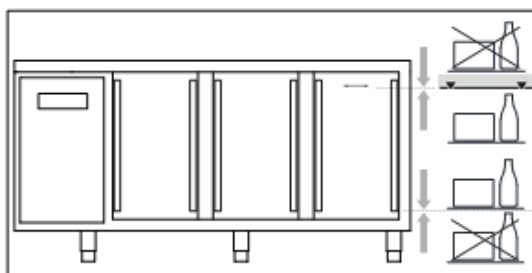

STOPPING

In any condition and for stopping the machine it is enough to press the main switch 1 in OFF position; the pilot light of the switch will go out.

WARNING: the main switch 1 DOES NOT insulate the machine from the electric current.

Set the general cut-out in OFF position.

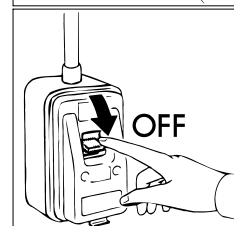
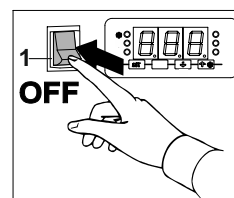

To insulate the refrigerator from the electric current, remove the plug from the socket.

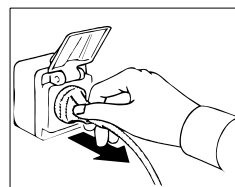

WORKING IRREGULARITIES

In case of working irregularities, before to call the technical service in zone verify that:

- the main switch 1 is on and the current is present;
- the regulated temperature is the wished one;
- the doors are perfectly closed;
- the machine is not near heat sources;
- the condenser is clean and the fan works regularly;
- an excess of hoarfrost does not cover the evaporating panel.

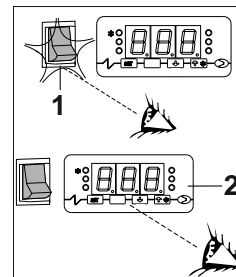

In case of negative result, contact the nearest service centre indicating the model and the serial number shown on the rating placed on the appliance instrument panel.

USAGE INTERRUPTIONS

In case of longer inactivity of the appliance and for maintaining it in the best state act as following:

- set the general cut-out in OFF position.
- remove the plug from the socket.
- empty the refrigerator and clean it as described In the chapter "CLEANING".
- let the doors open to avoid the forming of bad smell.

MALFUNCTIONING

Malfunctioning during operation is often due to banal causes , which may nearly all be resolved without the help of a specialised technician. Consequently, before getting in touch with a service centre, check the following:

PROBLEM	POSSIBLE CAUSES
The appliance does not start	Check that the plug is properly inserted into the socket.
	Check that there is voltage at the socket
The internal temperature is too high	Check the thermostat setting
	Check for a heat source in the vicinity
	Check that the door closes properly
The appliance is excessively noisy	Check that the appliance is standing level. A lopsided appliance could set off vibrations
	Check that the appliance is not touching other appliances or parts which could resonate
There are unpleasant smells inside the refrigerator	There are foodstuffs with a particularly strong smell (for example cheese and melon), placed in non-sealed containers
	Internal surfaces must be cleaned
Some condensation is produced on the appliance	Room humidity is very high
	Doors are not well-closed

Upon completion of the above checks, if the fault persists, contact an authorised service centre. Always indicate:

- the nature of the fault
- the model and the serial number that can be found on the technical feature plate, placed under the appliance instrument panel.

REFRIGERANT MATERIAL SAFETY DATA SHEET

R290

GWP = 3
ODP = 0

❖ Hazards identification

Liquefied gas - Extremely flammable

❖ First aid measures

• *Inhalation:*

In high concentrations may cause asphyxiation. Symptoms may include loss of mobility and/or consciousness. Victims may not be aware of asphyxiation. In low concentrations, may cause narcotic effects. Symptoms may include dizziness, headache, nausea and loss of coordination. Remove victim to an uncontaminated area wearing self contained breathing apparatus. Keep the patient relaxed and warm. Call a physician. Apply artificial respiration if breathing stops..

• *Contact with skin and eyes:*

In case of spillage, rinse thoroughly with water for at least 15 minutes

• *Ingestion:*

Route of exposure unlikely

❖ Informazioni ecologiche

Ecological information No known ecological damage caused by this product

WIRING DIAGRAM PLATE

The electrical diagram is shown on the last page of the booklet.

Pos	DESCRIPTION	Pos	DESCRIPTION
1	COMPRESSOR	20C	DOOR ANTICONDENSING RESISTOR
2	CONDENSER FAN	21	DOOR ANTICONDENSING RESISTOR
3	TERMINAL BOARD	22	TRY BOTTOM RESISTOR
6	MAIN SWITCH	44	RESISTANCE FOUND BASIN
8	PLUG	69	RELAY COMPRESSOR
9	EVAPORATOR FUN	75	GROUNDING TERMINAL
12	SOLENOID VALVE DEFROSTING	88	SOLENOID VALVE
20	DOOR ANTICONDENSING RESISTOR	90	DIGITAL THERMOREGULATOR
20A	DOOR ANTICONDENSING RESISTOR	102	DIGITAL THERMOREGULATOR
20B	DOOR ANTICONDENSING RESISTOR		

INHALT

SICHERHEITSINFORMATIONEN.....	2
SICHERHEITS VORSCHRIFTEN.....	2
BESCHREIBUNG	4
IDENTIFIKATIONS ETIKETTE.....	4
ABMESSUNGEN	5
EINRICHTUNG.....	7
REINIGUNG UND ALLGEMEINE WARTUNG	8
MAINTENANCE GERÄT EDELSTAHL.....	8
MAINTENANCE KABINETTE VX-PET	10
ENTSORGUNG.....	10
ALLGEMEINE MERKMALE BEI DER ABLIEFERUNG	11
ZUBHÖR	11
HACCP VORSCHRIFTEN.....	11
TECHNISCHE EIGENSCHAFTEN	12
SCHALTTAFELN.....	13
INGANGSETZEN UND BETRIEB	13
BLOCKIEREN/FREIGEBEN DER TASTATUR.....	13
SOLLWERT UND KONFIGURATIONSPARAMETER	14
KONTROLLE FEUCHTIGKEIT (<i>nur bei Geräten Pastry & Bakery</i>).....	21
ALARM UND ANZEIGEN.....	21
ENTFROSTUNG	24
BESCHICKUNG DES PRODUKTES.....	24
ANHALTEN.....	24
BETRIEBSSTÖRUNGEN	25
AUFBEWAHREN BEI LÄNGERER NICHTBENUTZUNG.....	25
BETRIEBSSTÖRUNGEN.....	25
TECHNISCHES DATENBLATT FÜR KÜHLMITTEL	26
ELEKTRISCHES SCHALTBILD	26

SICHERHEITSINFORMATIONEN

WARNUNG: Dieses Gerät enthält tige kohlenwasserstoff kältemittel (R290).

GEFAHR: Feuer oder explosionsgefahr. Brennbares kältemittel in gebrauch. Benutzen sie keine gegenstände für die enteisung des kühlschranks. Kältemittelleitungen dürfen nicht angestochen werden..

GEFAHR: Feuer oder explosionsgefahr. Brennbares kältemittel in gebrauch. Reparatur nur durch fachpersonal. Kältemittelleitungen dürfen nicht angestochen werden.

ACHTUNG: Feuer oder explosionsgefahr. Brennbares kältemittel in gebrauch. Beachten sie reparaturanleitung/benutzerhinweise vor serviceeinsatz. Alle sicherheitsvorkehrungen müssen befolgt werden.

ACHTUNG: Feuer oder explosionsgefahr. Ordnungsgemässe entsorgung nur gemäss vorschrift. Brennbares kältemittel in gebrauch.

ACHTUNG: Feuer oder explosionsgefahr bei anstechen der kältemittelleitungen. Befolgen sie die anweisungen genau. Brennbares kältemittel in gebrauch.

ACHTUNG: Nicht blockieren. Alle lüftungsschlitze müssen freibleiben wenn das gerät umbaut oder eingebaut ist.

ACHTUNG: explosive Stoffe wie Spraydosen mit einem brennbaren Treibmittel nicht in diesem Gerät aufbewahren.



Anzeige einer Entzündungsgefahr aufgrund des Vorhandenseins eines entzündlichen Kältemittels (R290)

Anleitungen finden Sie auf der Website www.sagispa.it

SICHERHEITS VORSCHRIFTEN

Die Geräte sind mit einem Stromkabel mit Stecker versehen.

ACHTUNG: vorher jede Wartung oder Reinigung muss man zuerst die Maschine vom Strom isolieren:

– Der Netzschalter auf OFF stellen.

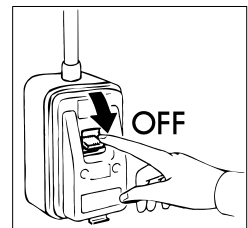

– Der stecker herausziehen. Die Entfernung des Steckers muss so erfolgen, dass der Bediener die Trennung des Steckers von jedem Arbeitspunkt überprüfen kann.

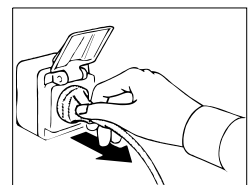

ACHTUNG: kein Stecker oder Steckdose ohne Erdung gebrauchen.

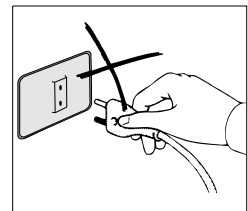

Die Steckdose muss mit ERDUNG gestattet sein.

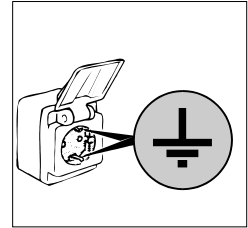

ACHTUNG: keine Adapter oder Verlängerungen für die Verbindung gebrauchen.

ACHTUNG: Wenn das Netzkabel beschädigt ist, muss es durch einen Original-Ersatz durch einen Service oder qualifiziertes Personal ersetzt werden.

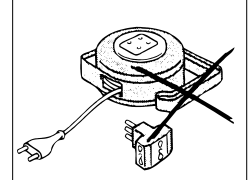

Die Reinigung und die Wartung der Kühlanlagen und des Kompressorenraumes verlangt der Eingriff von einem berechtigten Fachmann, dafür können sie nicht von unfähige Personen ausgeführt werden.



Für Wartungen oder im Zufall von Anomalien die Maschine vollständig abschalten; der Eingriff eines berechtigten KUNDENDIENST und originale Ersatzteile fordern. Die Nichtbeachtung der oben aufgeführten Angaben kann die Sicherheit der Geräte beeinträchtigen.

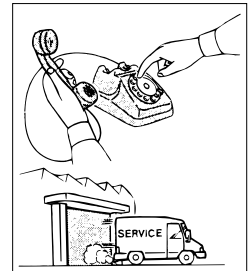

ACHTUNG: nach der Inbetriebnahme warten, bis die eingestellte Temperatur erreicht ist, bevor das zu lagernde Lebensmittel eingelegt wird.

Die Speisen immer mit dem dazu bestimmten Film zudecken.

ACHTUNG: Keine warmen Getränke oder Lebensmittel im Gerät lagern.

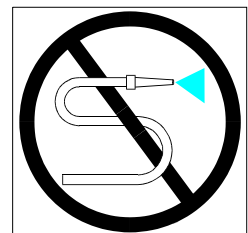

ACHTUNG: Nicht bei geöffneter Tür um das Gerät putzen.

Reinigen Sie das Gerät nie mit direktem Wasserstrahl oder hohem Druck.

ACHTUNG: Keine Reinigungsmittel auf Chlorbasis (Bleichlauge, Salzsäure, usw. ...) oder anderweitig giftigen Mittel zur Pflege oder in der Nähe der Geräte benutzen.

ACHTUNG: Zum Beschleunigen des Abtauvorgangs keine anderen mechanischen oder sonstigen Mittel als die vom Hersteller empfohlenen verwenden.

ACHTUNG: keine elektrischen Geräte in Fächern verwenden, die nicht vom Hersteller empfohlen werden.



Das Gerät ist für einen Schalldruckpegel unter 70db(A) ausgelegt.

BESCHREIBUNG

Dieses Gerät wurde für die Kühlung und Konservierung von Nahrungsmitteln entwickelt. Jeder andere Gebrauch ist als unsachgemäß anzusehen.

ACHTUNG: DIE Maschinen sind nicht für die Installation im Freien und/oder in Umgebungen geeignet, die atmosphärischen Einflüssen ausgesetzt sind. Nicht in explosionsgefährdeten Bereichen verwenden.

Der Hersteller lehnt jegliche Verantwortung für unsachgemäße Anwendungen der Produkte ab.

Die Kühltische haben auf der Oberseite eine Arbeitsfläche, die auch mit einem an der rückwärtigen Seite erhöhten Rand erhältlich ist.

Darüber hinaus sind auch Produkte ohne Arbeitsfläche erhältlich, die ähnliche Kühlleistungen erbringen.

Die Steuerungen sind mit Digitalwärmeregler und Hauptschalter.

Der Motorblock befindet sich in einem Gehäuse auf der linken Seite des Unterschranks.

Der Verdampfer ist innerhalb des jeweiligen Motorgehäuses untergebracht und mit entsprechenden Blechen geschützt.

Die Innenbelüftung erfolgt mittels geschützter Tangentialventilatoren, die sich oberhalb des Verdampfers befinden.

Der Apparat ist mit automatischer Kondensverdampfung ausgestattet

Die Bereiche, die in Kontakt mit dem Produkt kommen, bestehen aus Stahl oder sind mit lebensmittelechtem Kunststoffmaterial überzogen.

Bei Lagerung eine gute Belüftung, eine Temperatur zwischen -20°C und +50°C, eine relative Luftfeuchte von 30% bis 80% sowie eine trockene, nicht staubige Atmosphäre gewährleisten.

IDENTIFIKATIONS ETIKETTE

Das Typenschild ist fest auf dem Kühltisch angebracht und enthält wichtige Angaben zu den technischen Leistungen und Konstruktionsmerkmalen.

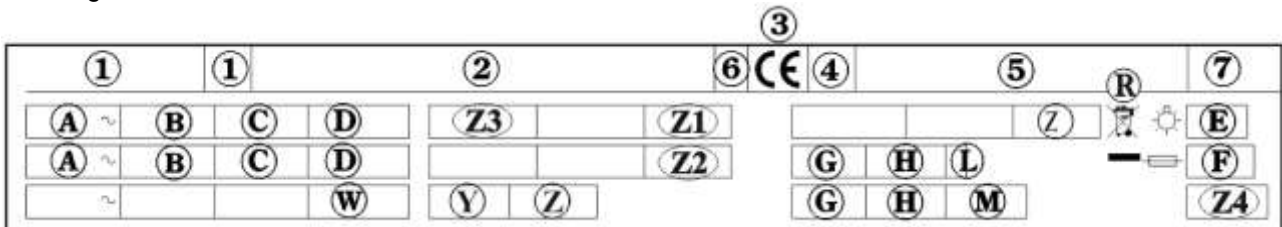

Inhaltsfeld des technischen Gerätedatenschildes

- | | |
|--|---|
| <ul style="list-style-type: none"> 1) MODELL 2) BAUFIRMA UND ADRESSE 3) MARKIERUNGSSIEGEL CE 4) BAUJAHR 5) KENNUMMER 6) ELEKTR. ISOLATIONSKLASSE 7) ELEKTR. SCHUTZKLASSE A) SPEISESPANNUNG B) STROMSTÄRKE C) SPEISEFREQUENZ D) NENNLEISTUNG | <ul style="list-style-type: none"> E) GESAMTLEISTUNG LAMPEN F) ABSCHMELZSTROM G) KÜHLGASTYP H) KÜHLGASMENGE L) TEMPERATURKLASSE ANLAGE R) WEEE-SYMBOL W) HEIZKÖRPERLEISTUNG Z1) NETTOVOLUME (RSV) Z2) FLUID FOAMING Z3) BETRIEBSTEMPERATUR Z4) GWP |
|--|---|

Klimaklasse*	Umgebungstemperatur
3 (SN)	+10°C ---> +32°C
4 (N)	+16°C ---> +32°C
4+ (ST)	+16°C ---> +38°C
4+ (SN-ST)	+10°C ---> +38°C
5 (T)	+16°C ---> +43°C
5 (SN-T)	+10°C ---> +43°C

(*) Die klimatische Temperaturklasse gibt die Umgebungstemperatur an, bei der das Gerät betriebsfähig ist.

ABMESSUNGEN

Beachten Sie die Maße Ihres Geräts.

- Modelle Tiefe 600

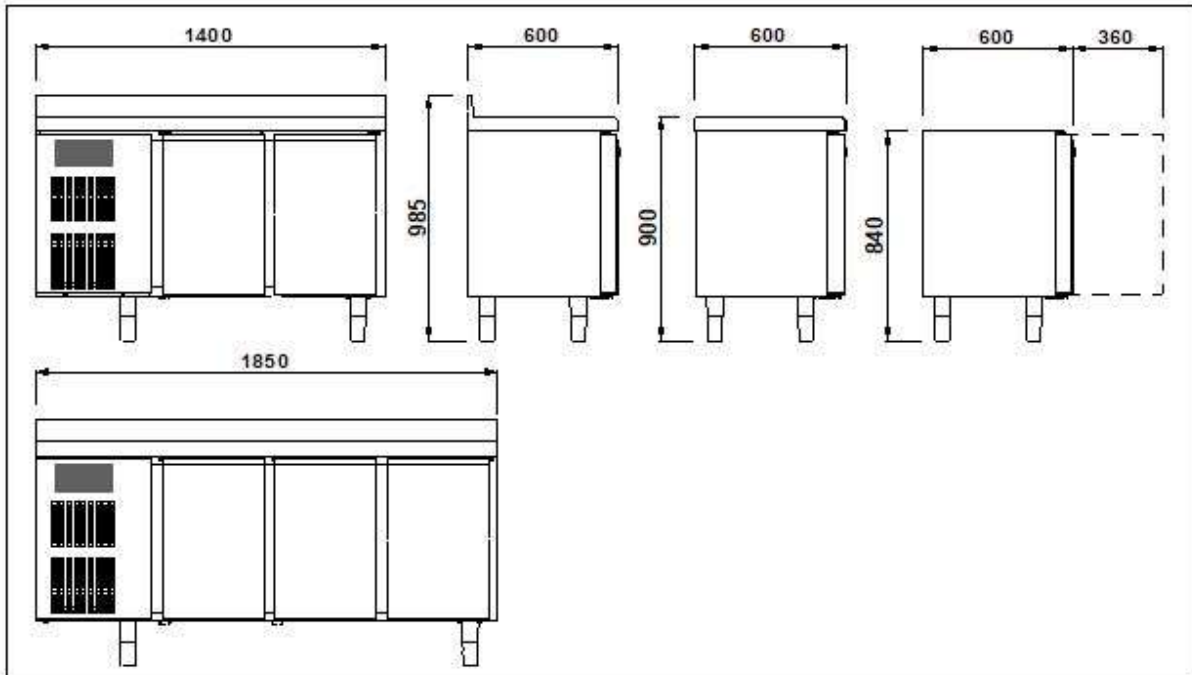

- Modelle Tiefe 700

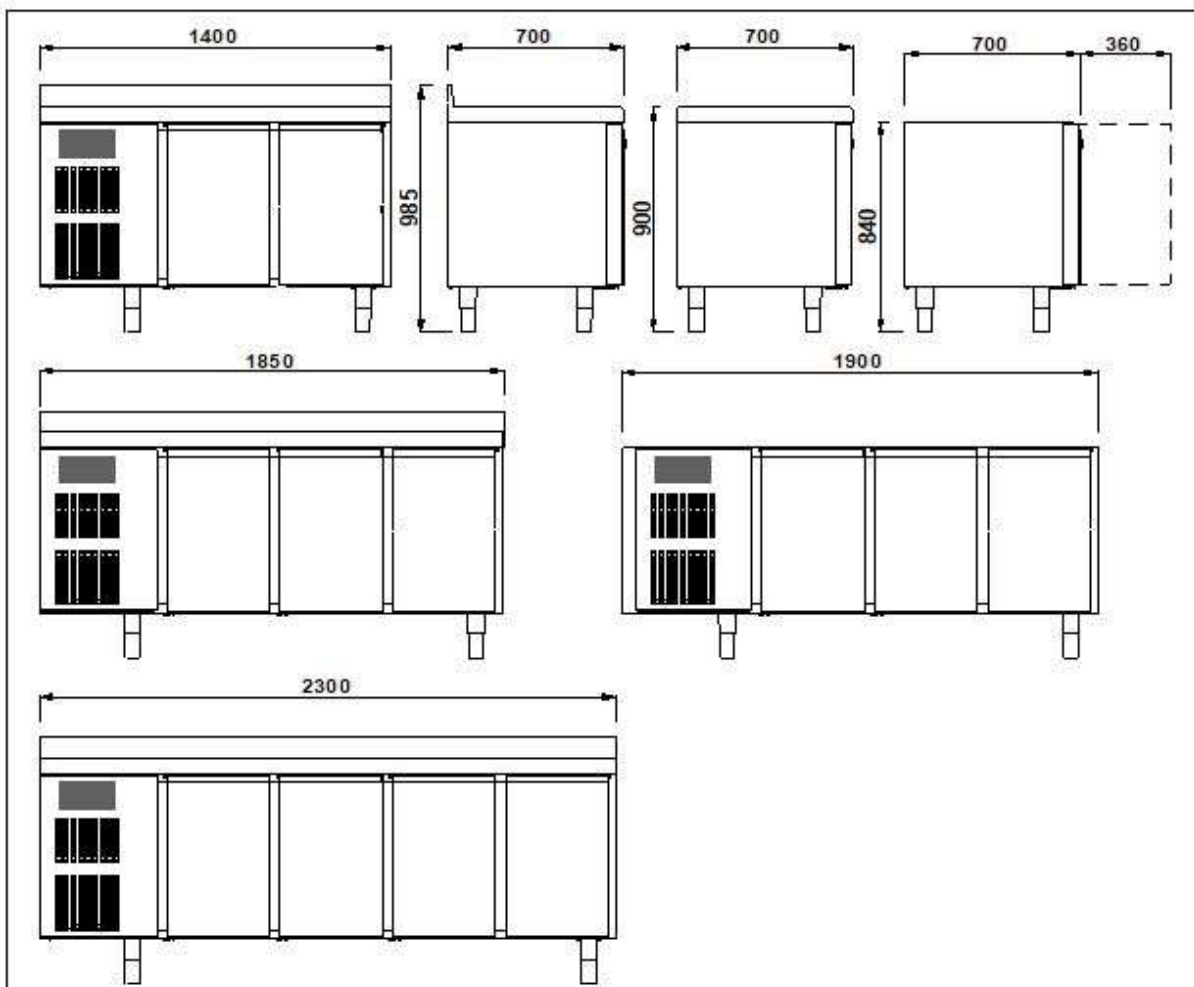

- Modelle snack

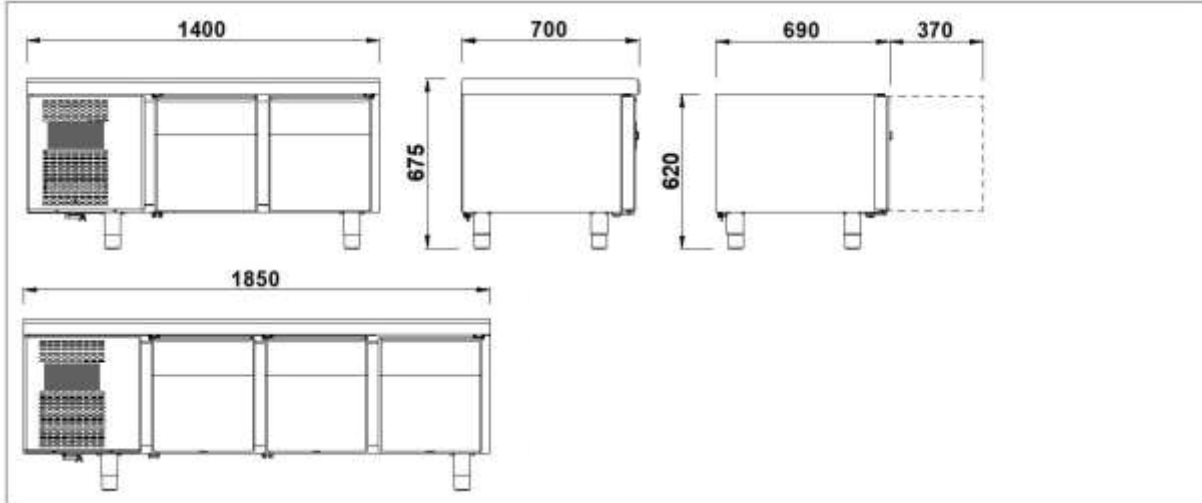

- Modelle pastry & bakery

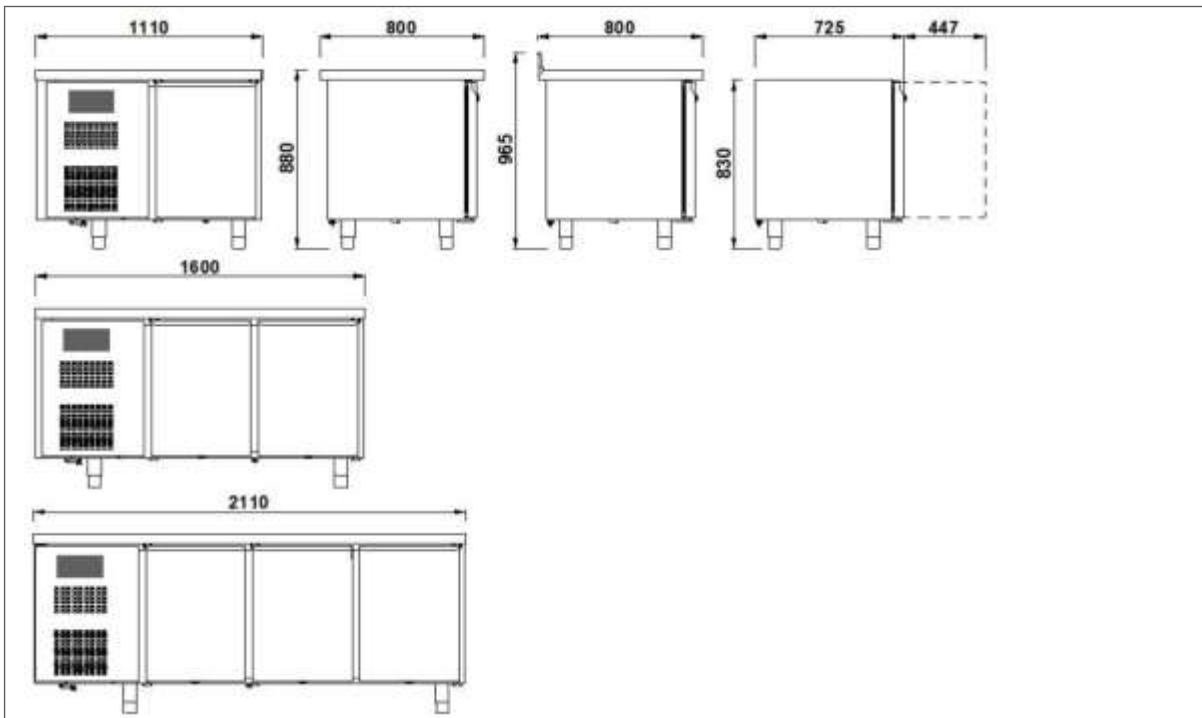

- Modelle pizza

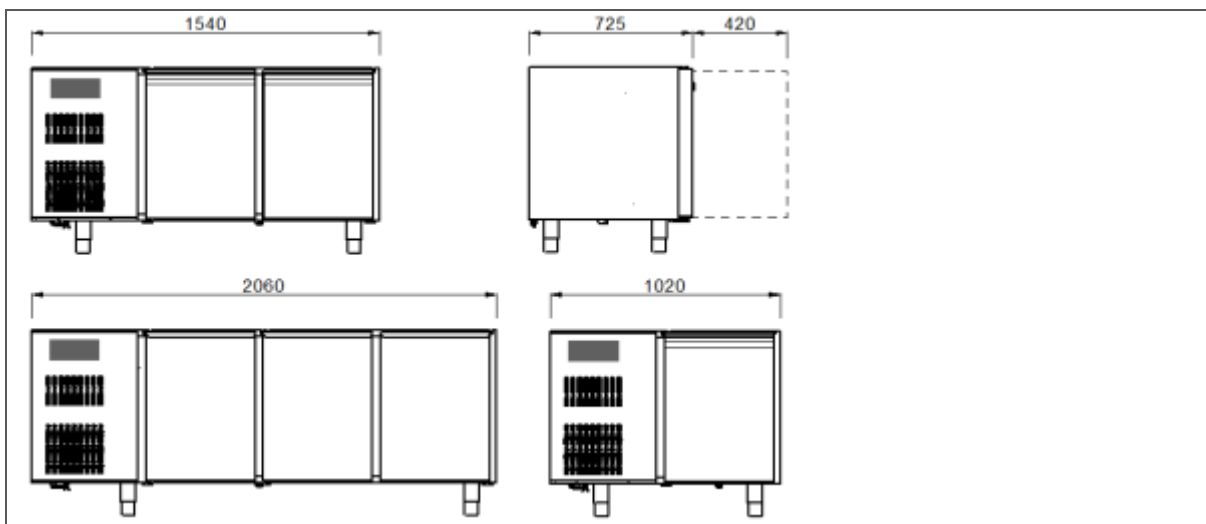

EINRICHTUNG

Die Geräte werden stets auf Paletten mit einem Schutzumkarton versehen versandt.

Nach Empfangnahme und Auspacken sind bei Feststellung eventueller Schäden oder fehlender Teile die im Kapitel "ALLGEMEINE LIEFERHINWEISE" genannten Hinweise zu befolgen.

Die Inbetriebnahme und Installation des Gerätes darf nur von geschultem Personal vorgenommen werden.



Achten Sie beim Entfernen Sie des Umkartons darauf, die Oberflächen des Gerätes nicht zu beschädigen.

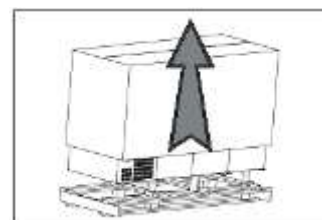

ACHTUNG: Verpackungsmaterialien (Plastikbeutel, Styroporteile, Metallklammern usw.) müssen für Kinder unzugänglich gelagert werden.

Heben Sie das Gerät mit einem Hebewagen an und bringen Sie es an den vorgesehenen Aufstellungsort. Achten Sie darauf, daß der Hebewagen nicht ungleich belastet wird.

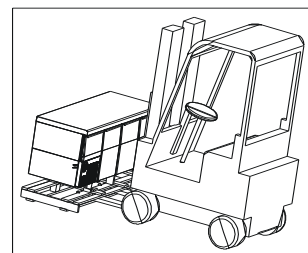

ACHTUNG: Sowohl bei der Beförderung zum Aufstellungsort als auch beim späteren Umstellen darf das Gerät nicht geschoben oder gezogen werden, da es andernfalls umkippen und dabei beschädigt werden könnte.

ACHTUNG: Stellen Sie das Gerät nicht in der Nähe von Wärmequellen oder in sehr warmen Räumen auf, da sich die Kühlleistung sonst vermindert und die Kühlanlage stark belastet wird.

Stellen Sie das Gerät am endgültigen Standort auf. Stellen Sie sicher, dass der Raum entsprechend belüftet wird. Geräte nicht in Umgebungen oberhalb der angegebenen Klimaklasse verteilen.



Entfernen Sie die Schutzfolie des Gerätes. Sie können hierbei leichte elektrostatische Schläge erhalten, die jedoch nicht gefährlich sind. Zur Verminderung dieses Effekts genügt es, die Hand beim Abziehen der Folie stets auf dem Gerät oder aber die Folie in Kontakt mit dem Boden zu halten.

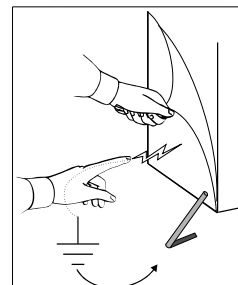

Stellen Sie nun die Füße so ein, daß das Gerät korrekt ausgerichtet ist.

Beim Ausrichten ist das Gerät leicht nach hinten geneigt zu halten, um ein besseres Schließen der Türen zu gewährleisten.

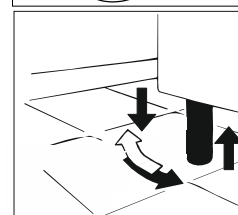

Reinigen Sie das Gerät mit lauwarmem Wasser und Neutralreiniger (siehe Kapitel "REINIGUNG") und installieren Sie die eventuell vorhandenen Zubehörteile.

Versichern Sie sich, daß die Versorgungsspannung den Angaben auf dem Typenschild entspricht.

ACHTUNG: Versichern Sie sich, daß die Netzsteckdose geerdet ist. Sorgen Sie ggf. dafür, daß eine entsprechende Erdung vorgenommen wird.

Stecken Sie den Stecker in die Steckdose ein.

Das Gerät muß in ein Äquipotentialsystem eingebaut werden, dessen Leistung auf der Grundlage der geltenden Normen überprüft werden muß. Der Anschluß erfolgt mittels einer im Kompressorbereich befindlichen Schraube mit dem Aufdruck "äquipotentiell".

Das Gerät ist nun betriebsbereit.

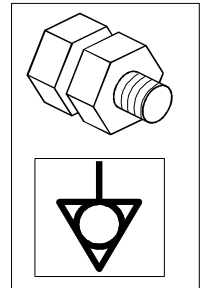

REINIGUNG UND ALLGEMEINE WARTUNG

Für eine beständige Leistung des Kühlschranks muss man die Reinigung und die allgemeine Wartung durchführen.

Bevor anzufangen vorgehen wie folgen:

- Der Netzschalter auf OFF stellen
- der Stecker von der Steckdose herausziehen und bis zur kompletter Entfrostung warten.

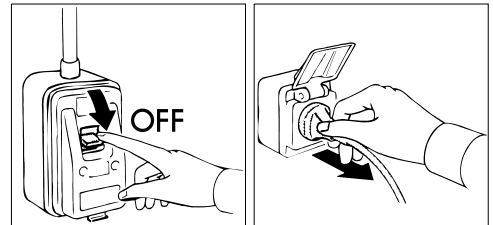

Den Kondensator der Kühlgruppe sorgfältig mit einem Staubsauger, Pinsel oder einer nichtmetallischen Bürste putzen.

ACHTUNG: Die Reinigung und die Wartung der Kühlanlagen und des Kompressorenraumes verlangt der Eingriff von einem berechtigten Fachmann, dafür können sie nicht von unfähige Personen ausgeführt werden.

Die innere und äussere Flächen mit Wasser und Seife oder neutralen Reinigungsmittel waschen; ein wenig Essig kann eventuelle Gerüche entfernen. Mit reines Wasser spülen und sorgfältig trocknen.

Die Reinigung und die allgemeine Wartung sind jetzt zu Ende.

MAINTENANCE GERÄT EDELSTAHL

TGLICHE REINIGUNG

Damit eine perfekte Hygiene und eine Erhaltung des Gerät garantiert wird, sollten die folgenden Reinigungsverfahren ordentlich und/oder täglich durchgeführt werden:

1. Die Oberflächen des Gerät gründlich mit Wasser und säurefreiem Reinigungsmittel anhand eines sanften und ausgewringten Schwammes putzen, und dies nur der Richtung des Satinierens nach.
2. Das Reinigungsmittel darf kein Chlor enthalten und soll nicht abrasiv sein.
 - 2a. Folgende Reinigungsmittel werden empfohlen:
 - Desinfektionsreiniger mit kombinierter Wirkung (die, nicht ionische grenzflächenaktive Stoffe, Chloridbenzal, Chelatsubstanzen und PH Puffer, enthalten)
 - säurefreie Laborreiniger , für manuelles Abwaschen (die, anionische und nicht ionische grenzflächenaktive Stoffe, enthalten)
 - Entfettungsmittel fürs Nahrungsmilieu (die, anionische grenzflächenaktive Stoffe und EDTA, enthalten)

3. Vor dem Gebrauch die Reinigungsmittel eventuell gemäß der auf das Etikett aufgetragenen Vorschriften verdünnen.
4. Die Reinigungsmittel mindestens 5 minutenlang einwirken lassen.
5. Die Gerät mehrmals mit einem Schwamm und fließendem Wasser abspülen.
6. Mit einem sauberen Schwamm sorgfältig abtrocknen.

ACHTUNG: absolut keine Werkzeuge die zerkratzen können mit herrührende Rostbildung, gebrauchen.

SPEISEFLECKEN UND GEHRTETEN RESTE

Wenn die Reste schon gehärtet sind, wie folgt verfahren:

1. Einen ins lauwarme Wasser eingetauchten sanften Schwamm und säurefreien Reiniger benutzen (man kann diejenigen gebrauchen, die für das tägliche Putzen vorgesehen sind und zwar mit der höchsten Konzentration unter denen, die auf das Etikett vorgesehen sind).
2. Den gehärteten Rückstand anfeuchten, indem man zirka alle 5 Minuten mit dem ins Wasser eingetauchten Schwamm und Reinigungsmittel über den gehärteten Schmutz wischt, um diesen somit wenigstens 30 minutenlang feucht zu halten.
3. Am Ende des Einweichens den Rückstand mit dem ins Wasser eingetauchten Schwamm und säurefreien Reinigungsmittel entfernen.
4. Wenn nötig, eine Holzspachtel oder eine rostfreie Stahllanzette benutzen und darauf achten, dass die Oberfläche des Gerätes nicht beschädigt werden.
5. Am Endpunkt des Verfahrens sollte ein täglicher Reinigungskreislauf aller Innenflächen des Gerät getätigt werden.
6. Am Ende der Reinigung mehrmals mit einem Schwamm und fließendem Wasser abspülen.
7. Mit einem sauberen Schwamm gründlich abtrocknen.

Auch der Boden unter und herum den Schrank muss sauber und in vollkommene Hygiene gehalten sein. Mit Wasser und Seife oder neutralen Reinigungsmittel waschen.

Die Bleche mit Silikonwachs schützen.

WERTVOLLE RTE FR DIE PFLEGE DES ROSTFREIER STAHLS

Für die Reinigung und die Wartung der stahlernen Teilen, sich an folgendes halten, und bedenken dass die wichtigste Regel die Hygiene und Nichtgiftigkeit ist.

Der rostfreier Stahl hat eine dünne Oxidschicht die den Rost vermeidet. Es gibt jedoch Stoffe, die diese Schicht zerstören können, und Korrosion verursachen.

Vorher man irgendwelches Produkt gebraucht, immer sich beim Verkäufer erkundigen, welches Produkt am besten geeignet ist und keine Korrosion verursacht.

Im Zufall von Kratzen muss man mit einem Schwamm aus feinen ROSTFREIEN STAHL oder mit einem abschleifenden synthetischen Schwamm in der Richtung der Satinierung reiben.

ACHTUNG: für den ROSTFREIER STAHL nie eisene Schwämme gebrauchen, und sie nie auf den Flächen liegen lassen, weil Eisenreste durch Verunreinigung Rostbildungen bilden können.

MAINTENANCE KABINETTE VX-PET

Damit eine perfekte Hygiene und eine Erhaltung des Gerät garantiert wird, sollten die folgenden Reinigungsverfahren ordentlich und/oder täglich.

Bei Nahrungsflecken oder –reste an der Außenfläche, gründlich mit Wasser abwaschen und entfernen, bevor diese verhärten.

Falls die Nahrungsreste bereits verhärtet sind, einen weichen in Terpentin oder in denaturierten Alkohol eingetauchten Schwamm benutzen.

Bei Nahrungsflecken oder –reste an der Innenfläche, kochender Weißessig oder denaturierter Alkohol und ein weiches Reinigungstuch benutzen.

In der Richtung des Satinierens reinigen.

Es ist empfehlenswert auf sämtlichen Gerätinnenflächen einen täglichen Reinigungszyklus durchzuführen.

Schleifmittel Mittel oder rostfreie Stahlschwämme, Aceton, Thrychloräthylen und Ammoniak vermeiden.

Am Ende der Reinigung mehrmals mit einem Schwamm und fließendem Wasser abspülen.

Mit einem sauberen Schwamm gründlich abtrocknen.

Auch der Boden unter und herum den Schrank muss sauber und in vollkommene Hygiene gehalten sein.

Mit Wasser und Seife oder neutralen Reinigungsmittel waschen.

ENTSORGUNG

MÜLLENTSORGUNG

Bei Ende des Lebenszyklus des Produktes, Apparat nicht in die Umwelt freisetzen. Die Türen müssen vor der Entsorgung des Gerätes demontiert werden.

Eine provisorische Lagerung des Mülls ist Hinblick auf eine Entsorgung mittels definitiver Behandlung und/oder Lagerung zulässig.

Trotzdem sind die im Land des Betreibers geltenden Gesetzgebungen des Umweltschutzes zu beachten.

VERFAHRENSWEISE HINSICHTLICH DER GROBEN DEMONTAGE DES GERÄTES

In verschiedenen Ländern gelten unterschiedliche Gesetzgebungen, daher sind die Vorschriften der Gesetzgebung und der Behörden des Landes zu beachten, in dem die Demolierung erfolgt.

Im allgemeinen ist der Kühlschrank an spezielle Sammel- und Zerlegungszentren abzugeben. Den Kühlschrank demontieren, indem die Bestandteile je nach ihrer chemischen Zusammensetzung zusammenzufassen sind, wobei darauf zu achten ist, daß sich in dem Kompressor Schmieröl und Kühlfüssigkeit befinden, die aufgefangen werden und wiederverwertbar sind, und daß es sich bei den Bestandteilen des Kühlschranks um Sondermüll handelt, der von den städtischen Behörden zu entsorgen ist.

Das Gerät ist vor der Entsorgung unbrauchbar zu machen, indem das Stromkabel und jegliche Schließvorrichtung entfernt werden, um zu vermeiden, daß jemand in seinem Inneren eingeschlossen werden kann.

DIE DEMONTIERARBEITEN SIND AUF JEDEN FALL VON QUALIFIZIERTEM FACHPERSONAL DURCHFÜHREN.

SICHERHEIT BEI DER ENTSORGUNG VON ELEKTRO- UND ELEKTRONIK-ALTGERÄTEN (WEEE-RICHTLINIE 2002/96/EG)

Umweltschädliche Stoffe dürfen nicht in die Umwelt gelangen. Die Entsorgung in Einklang mit den geltenden gesetzlichen Bestimmungen vornehmen.

Gemäß der WEEE-Richtlinie 2002/96/EG (Elektro- und Elektronik-Altgeräte) muss der Betreiber bei der endgültigen Außerbetriebnahme die Geräte bei den hierfür vorgesehenen Rücknahmestellen abgeben oder im Moment des Erwerbs neuer Geräte unzerlegt an den Verkäufer zurückgeben.

Alle Geräte, die in Einklang mit der WEEE-Richtlinie 2002/96/ EG entsorgt werden müssen, müssen mit dem entsprechenden Symbol gekennzeichnet sein .

Die gesetzwidrige Beseitigung von Elektro- und Elektronik-Altgeräten zieht Sanktionen nach Maßgabe der gesetzlichen Bestimmungen in dem Mitgliedstaat nach sich, in dem die Zuwiderhandlung begangen wurde.

Elektro- und Elektronik-Altgeräte können gefährliche Stoffe enthalten, die schädlich für die Gesundheit der Personen und für die Umwelt sein können. Daher müssen sie unbedingt vorschriftsmäßig entsorgt werden.

ALLGEMEINE MERKMALE BEI DER ABLIEFERUNG

Kontrollieren Sie bei der Lieferung, ob die Verpackung unverletzt ist und während des Transportes keinen Schaden genommen hat.

Überprüfen Sie, ob das Gerät den in der Bestellung angegebenen Merkmalen entspricht. Sollte dies nicht der Fall sein, setzen Sie sich bitte sofort mit Ihrem Händler in Verbindung.

Wir beglückwünschen Sie zu der von Ihnen getroffenen, ausgezeichneten Wahl. Damit Ihnen unsere Kühltische stets gute Dienste leisten, lesen Sie bitte die im vorliegenden Handbuch enthaltenen Anleitungen aufmerksam durch und befolgen Sie die notwendigen Vorsichtsmaßnahmen.

Beachten Sie, daß jede Art von Vervielfältigung des Handbuches unzulässig ist und die darin enthaltenen Daten aufgrund der ständigen Weiterentwicklung und Qualitätsverbesserung ohne vorherige Ankündigung geändert werden können.

ZUBHÖR

Auf Wunsch kann das Gerät mit folgenden Zubehörteilen ausgestattet werden "*see general catalogue*".

HACCP VORSCHRIFTEN

ACHTUNG: Rohes Gemüse, Eier und Geflügel dürfen **NICHT** in denselben Kühlfächer aufbewahrt werden. Das Geflügel muß getrennt aufbewahrt werden.

ACHTUNG: Lebensmittel die eine Temperatur zwischen 10°C und 60°C haben, müssen in geeigneten Kühlschränke (Tiefkühlschränke) aufbewahrt werden, sodaß die Temperatur den Kern des Lebensmittels erreicht.

ACHTUNG: Wenn man die Lebensmittel aus dem Kühlschrank nimmt, muß man das Ablaufdatum der Verpackungen kontrollieren und diejenige nehmen, die früher ablaufen. Wenn man ein ablaufendes Produkt sieht, muß man es wegnehmen und es dem Geschäftsleiter melden.

ACHTUNG: Die leicht verderbliche Lebensmittel müssen so spät wie möglich vom Kühlschrank weggenommen werden, sodaß sie nur für die allernötigste Zeit der Raumtemperatur ausgestellt sind.

ACHTUNG: Die aufgetaute Lebensmittel dürfen nicht wieder tiefgekühlt werden.

ACHTUNG: Die Vorrichtungen müssen numeriert werden und die Temperaturbestimmung muß zweimal täglich kontrolliert werden. Die Werte müssen schriftlich registriert und für 24 Monate aufbewahrt werden.

ACHTUNG: Eine elektrische Uhr registriert wie lange die eventuelle Stromunterbrechung dauert , um die beschädigte Lebensmitteln wegnehmen zu können.

Maximale zugelassene Warentemperaturen

Lebensmittel	Normale Lagerungs- temperatur (°C)	Maximale Transport- temperatur (°C)
Frische pasteurisierte Milch	0÷+4	9
Frische Sahne	0÷+4	9
Joghurt , quarkähnlicher Frischkäse und Frischkäse	0÷+2	9
gekühlte Fischprodukte	0÷+2	0÷+4
Rind- und Schweinefleisch	0÷+3	10
Geflügel	0÷+4	8
Kaninchen	0÷+2	8
kleines Wild	0÷+2	8
großes Wild	0÷+2	8
Innereien	0÷+3	8
Tiefkühlkost	-23÷-24	-18
Eis	-18÷-20	-18
Obst und Gemüse	0÷+4	Raumtemperatur

TECHNISCHE EIGENSCHAFTEN

In der letzten seite des handbuches: technische daten.

SCHALTAFELN

Alle Geräte sind mit einem Hauptschalter und einem Thermoregler versehen:

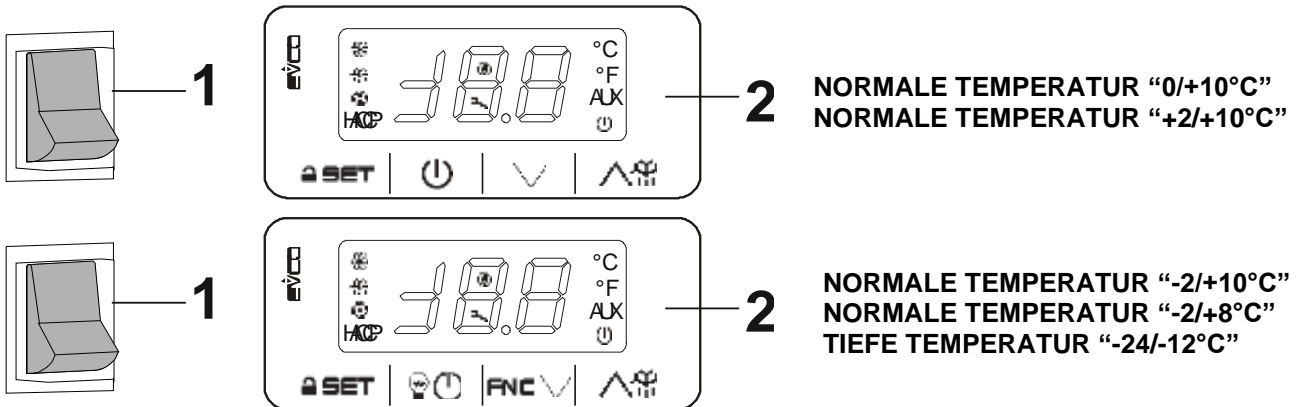

INGANGSETZEN UND BETRIEB

Gehen Sie zum Einschalten des Gerätes wie folgt vor:

- der Stecker in die Steckdose einfügen;
- Stellen Sie den Netzschalter auf ON;

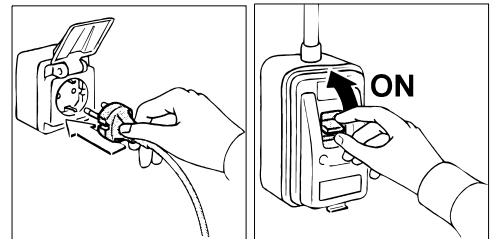

- Betätigen Sie den Hauptschalter (1). Die Kontrolleuchte des Schalters leuchtet auf; Bringen Sie das Gerät mit Hilfe des thermoregler (2) auf die gewünschte Betriebstemperatur.

Kontrollieren Sie nach einiger Zeit, ob die auf dem Display des thermoregler (2) eingestellte Temperatur angezeigt wird.

BLOCKIEREN/FREIGEBEN DER TASTATUR

Tastatur sperren:

- Sicherstellen, dass keine Prozedur läuft
- 30 s lang keine Eingabe machen: Auf dem Display wird 1 s lang "Loc" angezeigt und die Tastatur automatisch gesperrt.

Bei gesperrter Tastatur sind folgende Funktionen nicht verfügbar:

- Einschalten/Ausschalten vom Gerät
- Anzeigen der von den Sonden gemessenen Temperatur
- Manuelle Aktivieren vom Abtauen
- Einstellen vom Setpoint für den Betrieb

Diese Vorgänge führen dazu, dass der Wert "Loc" 1 s lang angezeigt wird.





Um die Tastatur zu entriegeln:

- Eine Taste 1 s lang gedrückt halten: Auf dem Display wird 1 s lang "UnL" angezeigt.

SOLLWERT UND KONFIGURATIONSPARAMETER

NORMALE TEMPERATUR "0/+10°C" "+2/+10°C"

Einstellung vom Setpoint Betrieb

- Sicherstellen, dass die Tastatur nicht gesperrt ist und dann keine Prozedur läuft
- Die Taste **SET** kurz drücken: die LED  blinkt
- Die Taste  oder die Taste  innerhalb von 15 s kurz drücken. Es werden auch die Parameter r1 und r2 angezeigt
- Die Taste **SET** kurz drücken oder 15 s lang keine Eingabe machen: Die LED  schaltet sich aus und das Gerät beendet die Prozedur.

Um die Prozedur vorzeitig zu beenden:

- Die Taste  kurz drücken (eventuelle Änderungen werden nicht gespeichert)



Der Setpoint Betrieb kann auch mit dem Parameter **SP** eingestellt werden.

Betriebssollwert



PARAM.	MIN.	MAS.	M.E.	SETPOINT BETRIEB
r1		r2	°C/°F (1)	Setpoint Betrieb; es werden auch r0 und r12 angezeigt

Einstellen der Konfigurationsparameter



Um die Prozedur aufzurufen:

- Sicherstellen, dass keine Prozedur läuft
- Die Taste **SET** 4 s lang gedrückt halten: Auf dem Display wird "PA" angezeigt
- Die Taste **SET** kurz drücken
- Die Taste  oder die Taste  innerhalb von 15 s kurz drücken, um den Wert einzustellen, der vom Parameter "PAS" vorgegeben wird (als Default ist der Wert mit -19 eingestellt)
- Die Taste **SET** kurz drücken oder 15 s lang keine Eingabe machen: Auf dem Display wird "SP" angezeigt

Um einen Parameter auszuwählen:

- Die Taste  o il tasto 

Zum Ändern eines Parameter:

- Die Taste **SET** kurz drücken
- Die Taste  oder die Taste  innerhalb von 15 s kurz drücken
- Die Taste **SET** kurz drücken oder 15 s lang keine Eingabe machen

Zum Beenden der Prozedur:

- Die Taste **SET** 4 s lang gedrückt halte oder 60 s keine Eingabe machen (eventuelle Änderungen werden gespeichert)

Konfigurationsparameter

PARAM.	MIN.	MAS.	M.E.	SETPOINT BETRIEB
SP	r1	r2	°C/°F (1)	Setpoint Betrieb; es werden auch r0 und r12 angezeigt

PARAM.	MIN.	MAS.	M.E.	ANALOGUE EINGÄNGE
CA1	-25	25	°C/°F (1)	Offset Sonde Raumtemperatur
CA2	-25	25	°C/°F (1)	wenn P4 = 1, Offset Sonde Verdampfer wenn P4 = 2, Offset Sonde Kondensator
P0	0	1	-	Sondentyp 0 = PTC 1 = NTC
P1	0	1	-	Kommastelle Grad Celsius (bei normalem Betrieb) 1 = JA
P2	0	1	-	Maßeinheit Temperatur (2) 0 = °C (Grad Celsius; die Auflösung hängt vom Parameter P1 ab) 1 = °F (Grad Fahrenheit; Auflösung 1 °F)
P4	0	2	-	Funktion vom zweiten Eingang 0 = digitaler Eingang (Mikroschalter Tür oder Multifunktion) 1 = analoger Eingang (Sonde Verdampfer) 2 = analoger Eingang (Sonde Kondensator)
P5	0	2	-	Wert, der bei normalem Betrieb angezeigt wird 0 = Raumtemperatur 1 = Setpoint Betrieb 2 = wenn P4 = 0, "- -" wenn P4 = 1, Temperatur vom Verdampfer wenn P4 = 2, Temperatur vom Kondensator
P8	0	250	0,1s	Verzögerung Anzeige Änderung der von den Sonden gemessenen Temperaturen

PARAM.	MIN.	MAS.	M.E.	HAUPTREGLER
r0	0.1	15	°C/°F (1)	Differenz Setpoint Betrieb; siehe auch r12
r1	-99	r2	°C/°F (1)	Mindestwert Setpoint Betrieb
r2	r1	99	°C/°F (1)	Höchstwert Setpoint Betrieb
r4	0	99	°C/°F (1)	Zunahme Setpoint Betrieb bei Funktion "energy saving"; siehe auch i0, i10 und HE2

r5	0	1	-	Betrieb für Kühlen oder Heizen (3) 0 = für Kühlen 1 = für Heizen
r12	0	1	-	Typ Differenz von Setpoint Betrieb 0 = asymmetrisch 1 = symmetrisch

PARAM.	MIN.	MAS.	M.E.	SCHUTZ VOM KOMPRESSOR
C0	0	240	min	Verzögerung Einschaltung Kompressor bei Einschalten Gerät (4)
C2	0	240	min	Mindestabschaltdauer Kompressor (5)
C3	0	240	s	Mindesteinschaltdauer Kompressor
C4	0	240	min	Abschaltdauer Kompressor bei Fehler Sonde Raumtemperatur (Code "Pr1"); siehe auch C5
C5	0	240	min	Einschaltdauer Kompressor bei Fehler Sonde Raumtemperatur (Code "Pr1"); siehe auch C4
C6	0	199	°C/°F (1)	Temperatur vom Kondensator bei deren Überschreiten der Alarm Kondensator überhitzt ausgelöst wird (Code "COH") (6)
C7	0	199	°C/°F (1)	Temperatur vom Kondensator bei deren Überschreiten der Alarm Kompressor blockiert ausgelöst wird (Code "CSd")
C8	0	15	min	Verzögerung Alarm Kompressor blockiert (Code "CSd") (7)

PARAM.	MIN.	MAS.	M.E.	ABTAUEN
d0	0	99	h	wenn d8 = 0, 1 oder 2, Abtauintervall 0 = Abtauen mit Intervall wird nie aktiviert wenn d8 = 3, maximales Abtauintervall
d2	-99	99	°C/°F (1)	Temperatur vom Verdampfer bei Ende Abtauen; siehe auch d3
d3	0	99	min	wenn P4= 0 oder 2, Dauer vom Abtauen wenn P4= 1, maximale Dauer Abtauen, siehe auch d2 0 = Abtauen wird nie aktiviert
d4	0	1	-	Abtauen bei Einschalten vom Gerät (4) 1 = JA
d5	0	99	min	wenn d4 = 0, Mindestzeit zwischen Einschalten vom Gerät und Aktivieren vom Abtauen (4) wenn d4 = 1, Verzögerung Abtauen bei Einschalten vom Gerät (4)
d6	0	2	-	Temperatur, die bei Abtauen angezeigt wird (nur wenn P5 = 0) 0 = Raumtemperatur 1 = Wenn die Raumtemperatur bei Aktivierung vom Abtauen unterhalb von "Setpoint Betrieb + Δt", liegt, maximal "Setpoint Betrieb + Δt"; wenn die Raumtemperatur bei Aktivierung vom Abtauen oberhalb vom "Setpoint Betrieb + Δt", liegt, maximal die Raumtemperatur bei Aktivierung vom Abtauen (8) (9) 2 = Wert "dEF"
d7	0	15	min	Dauer vom Abtropfen (beim Abtropfen bleibt der Kompressor ausgeschaltet)
d8	0	3	-	Aktivierung vom Abtauen 0 = MIT INTERVALLEN - NACH ZEIT - Das Abtauen wird aktiviert, wenn das Gerät insgesamt für die Zeitdauer d0 eingeschaltet geblieben ist 1 = MIT INTERVALLEN - NACH EINSCHALTUNG KOMPRESSOR – Das Abtauen wird aktiviert, wenn der Kompressor insgesamt für die Zeitdauer d0 eingeschaltet geblieben ist 2 = MIT INTERVALLEN - NACH TEMPERATUR VOM VERDAMPFER – Das Abtauen wird aktiviert, wenn die Temperatur vom Verdampfer insgesamt für die Zeit d0 (10) unterhalb der Temperatur d9 geblieben ist. 3 = ADAPTIV - Das Abtauen wird in Intervallen eingeschaltet, deren Dauer jeweils von der Einschaltdauer des Kompressors, der Temperatur vom Verdampfer und der Aktivierung vom Eingang Mikroschalter Tür abhängt; siehe auch d18, d19, d20, d22, i13 und i14 (10)
d9	-99	99	°C/°F (1)	Temperatur vom Verdampfer, bei deren Überschreitung der Zähler vom Abtauintervall ausgesetzt wird (nur wenn d8 = 2)
d11	0	1	-	Aktivierung vom Abtaualarm beendet wegen maximaler Dauer (Code "dFd"; nur wenn P4 = 1 und wenn kein Fehler der Sonde vom Verdampfer vorliegt (Code "Pr2") 1 = JA
d16	0	999	min	Dauer vom Abtropfen (beim Abtropfen bleibt der Kompressor ausgeschaltet, der Ausgang vom Abtauen wird aktiviert und das Gebläse vom Verdampfer bleibt ausgeschaltet).
d18	0	999	min	Abtauintervall (das Abtauen wird aktiviert, wenn der Kompressor insgesamt mit der Temperatur vom Verdampfer unter der Temperatur d22 für die Zeitdauer von d18 eingeschaltet war; nur wenn d8 = 3) 0 = Abtauen wird nie durch diese Bedingung ausgelöst
d19	0	40	°C/°F (1)	Temperatur vom Verdampfer bei deren Unterschreitung das Abtauen aktiviert wird (bezogen auf den Mittelwert der Temperaturen vom Verdampfer bzw. "Mittelwert der Temperaturen vom Verdampfer - d19") (nur wenn d8 = 3)
d20	0	999	min	Mindesteinschaltdauer (konsekutiv) vom Kompressor, die das Aktivieren vom Abtauen auslöst 0 = Abtauen wird nie durch diese Bedingung ausgelöst
d22	0	19,9	°C/°F (1)	Temperatur vom Verdampfer bei deren Überschreitung das Abtauen ausgesetzt wird (bezogen auf den Mittelwert der Temperaturen vom Verdampfer bzw. "Mittelwert der Temperaturen vom Verdampfer + d22") (nur wenn d8 = 3); siehe auch d18

PARAM.	MIN.	MAS.	M.E.	TEMPERATURALARME (11) (12)
A1	0	99	°C/°F (1)	Raumtemperatur bei deren Unterschreitung der Alarm für Mindesttemperatur ausgelöst wird (Code "AL"; bezogen auf den Setpoint vom Betrieb bzw. "Setpoint Betrieb - A1"); siehe auch A11 0 = kein Alarm
A4	0	99	°C/°F (1)	Raumtemperatur bei deren Überschreitung der Alarm für Höchsttemperatur ausgelöst wird (Code "AH"; bezogen auf den Setpoint vom Betrieb bzw. "Setpoint Betrieb + A4"); siehe auch A11 0 = kein Alarm
A6	0	99	10 min	Verzögerung Alarm Höchsttemperatur (Code "AH") bei Einschalten vom Gerät (4)
A7	0	199	min	Verzögerung Alarm Mindesttemperatur (Code "AL") und Höchsttemperatur (Code "AH")
A11	0,1	15	°C/°F (1)	Differenz der Parameter A1 und A4

PARAM.	MIN.	MAS.	M.E.	DIGITALE EINGÄNGE
i0	0	4	-	Auswirkung bei Aktivierung vom digitalen Eingang 0 = keine Auswirkung 1 = MIKROSCHALTER TÜR - AKTIVIERUNG VOM ALARM EINGANG MIKROSCHALTER TÜR (Code "id") - Der Kompressor wird ausgeschaltet (maximal für die Zeitdauer i3 oder bis zur Deaktivierung vom Eingang); siehe auch i2 (13) 2 = MULTIFUNKTION - AKTIVIERUNG DER FUNKTION "ENERGY SAVING" - Die Funktion "energy

- Die Taste \wedge oder die Taste \vee innerhalb von 15 s kurz drücken, um den Wert einzustellen, der vom Parameter "PAS" vorgegeben wird (als Default ist der Wert mit -19 eingestellt)
- Die Taste **SET** kurz drücken oder 15 s lang keine Eingabe machen: Auf dem Display wird "SP" angezeigt

Um einen Parameter auszuwählen:

- Die Taste \wedge o il tasto \vee

Zum Ändern eines Parameter:

- Die Taste **SET** kurz drücken
- Die Taste \wedge oder die Taste \vee innerhalb von 15 s kurz drücken
- Die Taste **SET** kurz drücken oder 15 s lang keine Eingabe machen

Zum Beenden der Prozedur:

- Die Taste **SET** 4 s lang gedrückt halte oder 60 s keine Eingabe machen (eventuelle Änderungen werden gespeichert)

Konfigurationsparameter

LABEL	MIN.	MAS.	U.M.	SETPOINT BETRIEB
SP	r1	r2	°C/°F	Setpoint Betrieb; es werden auch r0 und r12 angezeigt

LABEL	MIN.	MAS.	U.M.	ANALOGUE EINGÄNGE
CA1	-25	25	°C/°F	Offset Zellenfühler Wenn P4 = 3: Offset Fühler Ausgangsluft
CA2	-25	25	°C/°F	Offset Verdampferfühler
CA3	-25	25	°C/°F	Offset Hilfsfühle
P0	0	1	-	Fühlertyp 0=PTC 1=NTC
P1	0	1	-	Freigabe Dezimalpunkt °C 0 = Nein 1 = Ja
P2	0	1	-	Maßeinheit Temperatur 0=°C 1=°F
P3	0	2	-	Funktion Verdampferfühler 0 = deaktiviert 1 = Abtauung + Lüfter 2 = Lüfter
P4	0	3	-	Funktion konfigurierbarer Eingang 0 = digitaler Eingang 1 = Kondensatorfühler 2 = Fühler kritische Temperatur 3 = Ausgangsluffühler wenn P4 = 3: Regeltemperatur = Produkttemperatur (CPT)
P5	0	4	-	Größe auf dem Display 0 = Regeltemperatur 1 = Setpoint 2 = Verdampfertemperatur 3 = Hilfstemperatur 4 = Einlasslufttemperatur
P7	0	100	%	Einlassluftgewicht für Berechnung Produkttemperatur (CPT) CPT = $\frac{[(P7 \times \text{Einlassluft}) + ((100 - P7) \times \text{Ausgangsluft})]}{100}$
P8	0	250	0,1 s	Display Refresh-Zeit

LABEL	MIN.	MAS.	U.M.	REGELUNG
r0	0.1	15	°C/°F	Setpoint-Differential
r1	-99	r2	°C/°F	Setpoint Mindestwert
r2	r1	99	°C/°F	Setpoint Höchstwert
r4	0	99	°C/°F	Offset Setpoint in Energy Saving
r5	0	1	-	Regelung für Warm oder für Kalt 0 = für Kalt 1 = für Warm
r6	0	99	°C/°F	Offset Setpoint in Overcooling/Overheating
r7	0	240	min	Dauer Overcooling/Overheating
r8	0	2	-	Zusatzfunktion Taste DOWN 0 = deaktiviert 1 = Overcooling/Overheating 2 = Energy Saving
r12	0	1	-	Position Differential r0 0 = asymmetrisch 1 = symmetrisch

LABEL	MIN.	MAS.	U.M.	KOMPRESSOR
C0	0	240	min	Verzögerung Kompressor ON ab Power-on
C2	0	240	min	Mindestzeit Kompressor OFF
C3	0	240	s	Mindestzeit Kompressor ON
C4	0	240	min	Zeit Kompressor OFF bei Alarm Zellenfühler
C5	0	240	min	Zeit Kompressor ON bei Alarm Zellenfühler
C6	0	200	°C/°F	Meldungsschwelle hohe Kondensation
C7	0	200	°C/°F	Alarmschwelle hohe Kondensation
C8	0	15	min	Alarmverzögerung hohe Kondensation
C10	0	9999	h	Stunden Kompressor für Wartung 0 = deaktiviert
C11	0	240	s	Verzögerung Einschalten Kompressor 2

C12	0	10	-	Anlaufzahl für Rotation Kompressoren 0 = deaktiviert
-----	---	----	---	---

LABEL	MIN.	MAS.	U.M.	ABTAUUNG
d00	0	1	-	abilita parametri tipo b 0 = no 1 = si
d01	r1	r2	°C/°F	Setpoint-Schwelle für Musterberechtigungen b ab SP > d01
d0	0	99	h	Intervall automatische Abtauung 0 = nur manuell wenn d8 = 3: maximaler Intervall
d0b	0	99	h	Intervall automatische Abtauung 0 = nur manuell wenn d8 = 3: maximaler Intervall
d1	0	2	-	Abtauungstyp 0 = elektrisch 1 = Heißgas 2 = für Kompressorstopp
d1b	0	2	-	Abtauungstyp 0 = elektrisch 1 = Heißgas 2 = für Kompressorstopp
d2	-99	99	°C/°F	Schwelle Abtauungsende
d2b	-99	99	°C/°F	Schwelle Abtauungsende
d3	0	99	min	Dauer Abtauung wenn P3 = 1: Höchstdauer
d3b	0	99	min	Dauer Abtauung wenn P3 = 1: Höchstdauer
d4	0	1	-	Freigabe Abtauung bei Power-on 0 = Nein 1 = Ja
d5	0	99	min	Verzögerung Abtauung ab Poweron
d6	0	2	-	Größe auf dem Display bei Abtauung 0 = Regeltemperatur 1 = Display gesperrt 2 = Label dEF
d7	0	15	min	Abtropfzeit
d7b	0	15	min	Abtropfzeit
d8	0	3	-	Betriebsart Zählung Intervall Abtauung Abtauung 0 = Stunden Gerät ON 1 = Stunden Kompressor ON 2 = Stunden Verdampfer Temperatur < d9 3 = adaptiv 4 = in Echtzeit
d9	-99	99	°C/°F	Schwelle Verdampfung für Zählung Intervall automatische Abtauung
d11	0	1	-	Freigabe Alarm Zeitüberschreitung Abtauung 0 = Nein 1 = Ja
d15	0	99	min	konsequente Zeit Kompressor ON für Abtauung Heißgas
d16	0	99	min	Zeit Vorabtropfen für Abtauung Heißgas
d18	0	999	min	Intervall adaptive Abtauung wenn Kompressor ON + Verdampfer Temperatur < d22 0 = nur manuell
d19	0	40	°C/°F	Schwelle für adaptive Abtauung (Relativwert bezogen auf die optimale Verdampfungstemperatur) optimale Verdampfungstemperatur - d19
d20	0	999	min	konsequente Zeit Kompressor ON für Abtauung 0 = deaktiviert
d21	0	500	min	konsequente Zeit Kompressor ON für Abtauung ab Power-on und ab Overcooling ab Overcooling 0... 500 min wenn (Regeltemperatur - Setpoint) > 10 °C/20 °F 0 = deaktiviert
d22	0	10	°C/°F	Schwelle Verdampfung für Zählung Intervall adaptive Abtauung (Relativwert bezogen auf die optimale Verdampfung) optimale Verdampfungstemperatur + d22

LABEL	MIN.	MAS.	U.M.	ALARME
AA	0	2	-	Anwahl Größe für Alarme hohe/niedrige Temperatur 0 = Regeltemperatur 1 = Verdampfer Temperatur 2 = Hilfstemperatur
A1	0	99	°C/°F	Alarmschwelle niedrige Temperatur
A2	0	2	-	Alarmtyp niedrige Temperatur 0 = deaktiviert 1 = Relativwert bezogen auf den Setpoint 2 = Absolutwert
A4	0	99	°C/°F	Alarmschwelle hohe Temperatur
A5	0	2	-	Alarmtyp hohe Temperatur 0 = deaktiviert 1 = Relativwert bezogen auf den Setpoint 2 = Absolutwert
A6	0	99	10 min	Verzögerung Alarm hohe Temperatur ab Power-on
A7	0	240	min	Verzögerung Alarme hohe/niedrige Temperatur
A8	0	240	min	Verzögerung Alarm hohe Temperatur nach Abtauung
A9	0	240	min	Verzögerung Alarm hohe Temperatur ab Schließung Tür
A10	0	240	min	Dauer Power Failure wegen Alarmspeicherung
A11	0,1	15	°C/°F	Differential Rücksetzen der Alarme hohe/niedrige Temperatur

LABEL	MIN.	MAS.	U.M.	LÜFTER
F0	0	4	-	Betriebsart Verdampferlüfter in Normalbetrieb 0 = OFF 1 = ON 2 = abhängig von F15 und F16 wenn Kompressor OFF, ON wenn Kompressor ON 3 = wärmerreguliert (mit F1) 4 = wärmerreguliert (mit F1) wenn Kompressor ON
F0b	0	4	-	Betriebsart Verdampferlüfter in Normalbetrieb 0 = OFF 1 = ON 2 = abhängig von F15 und F16 wenn Kompressor OFF, ON wenn Kompressor ON 3 = wärmerreguliert (mit F1) 4 = wärmerreguliert (mit F1) wenn Kompressor ON
F1	-99	99	°C/°F	Schwelle Regelung Verdampferlüfter
F1A	-99	99	°C/°F	Schwelle Verdampferlüfter ON wenn F1A > F1, Differential F1 = 2 °C/4 °F
F2	0	2	-	Betriebsart Verdampferlüfter in Abtauung und Abtropfen 0 = OFF 1 = ON 2 = abhängig von F0
F2b	0	2	-	Betriebsart Verdampferlüfter in Abtauung und Abtropfen 0 = OFF 1 = ON 2 = abhängig von F0
F3	0	15	min	Höchstzeit Stillstand Verdampferlüfter
F3b	0	15	min	Höchstzeit Stillstand Verdampferlüfter
F4	0	240	10 s	Zeit Verdampferlüfter OFF in Energy Saving
F5	0	240	10 s	Zeit Verdampferlüfter ON in Energy Saving
F7	-99	99	°C/°F	Schwelle Verdampferlüfter ON ab Abtropfen (Relativwert bezogen auf den Setpoint)
F9	0	240	s	Verzögerung Verdampferlüfter OFF ab Kompressor OFF
F10	0	99	°C/°F	Differenz "Zellentemperatur - Verdampfungstemperatur" für Verdampfer on
F11	0	99	°C/°F	Schwelle Kondensatorlüfter ON
F12	0	240	s	Verzögerung Kondensatorlüfter OFF ab Kompressor OFF
F13	0	15	°C/°F	Differential F11
F15	0	240	s	Zeit Verdampferlüfter OFF mit Kompressor OFF wenn F0 = 2
F16	0	240	s	Zeit Verdampferlüfter ON mit Kompressor OFF wenn F0 = 2

LABEL	MIN.	MAS.	U.M.	DIGITALE EINGÄNGE
i0	0	5	-	Funktion Eingang TürMikroschalter 0 = deaktiviert 1 = Kompressor + Verdampferlüfter OFF 2 = Verdampferlüfter OFF 3 = Zellenlicht ON 4 = Kompressor + Verdampferlüfter OFF, Zellenlicht ON 5 = Verdampferlüfter OFF, Zellenlicht ON
i1	0	1	-	Aktivierung Eingang TürMikroschalter 0 = mit geschlossenem Kontakt 1 = mit offenem Kontakt
i2	-1	120	min	Verzögerung Alarm Tür offen -1 = deaktiviert
i3	-1	120	min	Höchstzeit Regelsperre mit geöffneter Tür -1 = bis zur Schließung
i5	0	7	-	Funktion Eingang TürMikroschalter/Multifunktion 0 = deaktiviert 1 = Energy Saving 2 = Alarm iA 3 = Last über Taste ON 4 = Gerät ON/OFF 5 = Alarm Cth 6 = Alarm th 7 = Kompressor + Verdampferlüfter OFF, Zellenlicht ON 8 = Verdampferlüfter OFF, Zellenlicht ON
i6	0	1	-	Aktivierung Eingang TürMikroschalter/Multifunktion 0 = mit geschlossenem Kontakt 1 = mit offenem Kontakt
i7	0	120	min	Verzögerung Alarm Eingang Multifunktion -1 = deaktiviert wenn i5 = 5 oder 6: Verzögerung Kompressor ON ab Rücksetzen des Alarm
i10	0	999	min	konsequente Zeit Tür geschlossen für Energy Saving nachdem Regeltemperatur < SP 0 = deaktiviert
i13	0	240	-	Anzahl Türöffnungen für Abtauung 0 = deaktiviert
i14	0	240	min	konsequente Zeit Tür offen für Abtauung 0 = deaktiviert

LABEL	MIN.	MAS.	U.M.	USCITE DIGITALI
uc1	0	12	-	Konfiguration Relais K1 0 = Kompressor 1 = Abtauung 2 = Verdampferlüfter 3 = Zellenlicht 4 = Beschlagungsschutz 5 = Last über Taste 6 = Alarm

				7 = Heizelemente Tür 8 = Heizelemente für eine neutrale Zone 9 = Kondensatorlüfter 10= on/stand-by 11= Kompressor 2 12= deaktivier
uc2	0	12	-	Konfiguration Relais K2 (als uc1)
uc3	0	12	-	Konfiguration Relais K3 (als uc2)
uc4	0	12	-	Konfiguration Relais K4 (als uc3)
u2	0	1	-	Freigabe Zellenlicht und Last über Taste auf Standby 0 = Nein 1 = Ja manuell
u4	0	1	-	Freigabe Stillsetzen Ausgang Alarm 0 = Nein 1 = Ja
u5	-99	99	°C/°F	Schwelle Heizelemente Tür ON Differential = 2 °C/4 °F
u6	0	120	min	Dauer Beschlagungsschutz ON
u7	-99	99	°C/°F	Schwelle Neutralzone für Heizung (Relativwert bezogen auf den Setpoint) Setpoint + u7
u8	1	15	°C/°F	Differential von u7

LABEL	MIN.	MAS.	U.M.	ENERGY SAVING (wenn r5 = 0)
HE2	0	999	min	Höchstdauer Energy Saving -1 = bis zur Türöffnung

LABEL	MIN.	MAS.	U.M.	ENERGY SAVING IN ECHTZEIT (wenn r5 = 0)
H01	0	23	h	Uhrzeit Energy Saving Montag
H02	0	24		Höchstdauer Energy Saving

LABEL	MIN.	MAS.	U.M.	ABTAUUNG IN ECHTZEIT (wenn d8 = 4)
Hd1	-	-	-	Uhrzeit 1. Abtauung des Tages h- = deaktiviert
Hd2	-	-	-	Uhrzeit 2. Abtauung des Tages h- = deaktiviert
Hd3	-	-	-	Uhrzeit 3. Abtauung des Tages h- = deaktiviert
Hd4	-	-	-	Uhrzeit 4. Abtauung des Tages h- = deaktiviert
Hd5	-	-	-	Uhrzeit 5. Abtauung des Tages h- = deaktiviert
Hd6	-	-	-	Uhrzeit 6. Abtauung des Tages h- = deaktiviert

LABEL	MIN.	MAS.	U.M.	SCHUTZEINSTELLUNGEN
Pbu	0	2	-	Auswahl Event für Buzzer-Aktivierung 0 = deaktiviert 1 = alarme 2 = Tasten und Alarme
POF	0	1	-	Freigabe Taste ON/STANDBY 0 = Nein 1 = Ja
PAS	-99	999	-	password
PA1	-99	999	-	Password Level 1
PA2	-99	999	-	Password Level 2





LABEL	MIN.	MAS.	U.M.	UHR
Hr0	0	1	-	Freigabe Uhr 0 = Nein 1 = Ja

LABEL	MIN.	MAS.	U.M.	DATENLOGGING EVLINK
bLE	0	99	-	Konfiguration der seriellen Schnittstelle für Konnektivität 0 = kostenlos 1 = gezwungen für EVconnect oder EPoCA 2-99 = Lokale EPoCANetzwerkadresse
rE0	0	240	min	Intervall Probenentnahme Datenlogger
rE1	0	5	-	Anwahl Temperatur für Datenlogge 0 = keine 1 = Zelle 2 = Verdampfer 3 = Hilfsfühler 4 = Zelle und Verdampfer 5 = alle

LABEL	MIN.	MAS.	U.M.	MODBUS
LA	1	247	-	MODBUS-Adresse
Lb	0	3	-	Baudrate MODBUS 0 = 2.400 baud 1 = 4.800 baud 2 = 9.600 baud 3 = 19.200 baud Parität gleich

KONTROLLE FEUCHTIGKEIT (nur bei Geräten Pastry & Bakery)





Es ist möglich den gewünschten Feuchtigkeitswert entsprechend dem Nahrungsmittel, das man aufbewahren will zu entscheiden:

- Sicherstellen, dass die Tastatur nicht gesperrt ist und dann keine Prozedur läuft
- Die Taste **FNC**  für 2 s: Display zeigt das Feuchtigkeits-Label an (**rH⁺** = hoher Luftfeuchtigkeit oder **rH⁻** = geringe Feuchtigkeit)
- Die Taste **SET**  für 2 s zur Änderung der Einstellung
- Die Taste   um das Verfahren zu bestätigen und zu beenden.

ALARM UND ANZEIGEN

NORMALE TEMPERATUR "0/+10°C" "+2/+10°C"

Anzeigen

LED	BEDEUTUNG
	LED Kompressor LED an: Kompressor ist eingeschaltet LED blinkt: - Die Einstellung vom Setpoint Betrieb läuft - Ein Schutz vom Kompressor wurde ausgelöst
	LED Abtauen LED an: Abtauen läuft LED blinkt: Abtropfen läuft
	LED energy saving LED an und Display an: Energiesparfunktion läuft LED an und Display aus: Gerät im "Schlafmodus" Eine Taste drücken, um das Display wieder zu aktivieren
°C	LED Grad Celsius LED an: Die Maßeinheit für Temperatur sind Grad Celsius
°F	LED Grad Fahrenheit LED an: Die Maßeinheit für Temperatur sind Grad Fahrenheit
	LED ON/Standby LED an: Gerät ausgeschaltet (Standby)

Anzeigen

CODE	BEDEUTUNG
Loc	Tastatur ist blockiert
- - -	Die gewünschte Funktion ist nicht verfügbar
dEF	Abtauen läuft

Alarm

CODE	BEDEUTUNG
AL	Alarm Mindesttemperatur Abhilfe: - Die Raumtemperatur prüfen; siehe Parameter A1 Folgen: - Das Gerät funktioniert weiterhin ordnungsmäßig
AH	Alarm Höchsttemperatur Abhilfe: - Die Raumtemperatur prüfen; siehe Parameter A4 Folgen: - Das Gerät funktioniert weiterhin ordnungsmäßig
id	Alarm Eingang Mikroschalter Tür Abhilfe: - Prüfen, was die Aktivierung vom Eingang ausgelöst hat; siehe Parameter i0 und i1 Folgen: - Die mit Parameter i0 festgelegte Auswirkung

dFd	Alarm Abtauen beendet wegen Timeout: - Die Funktionstüchtigkeit der Sonde vom Verdampfer prüfen; siehe Parameter d2, d3 und d11 - Eine Taste drücken, um wieder auf normale Anzeige zu schalten Folgen: - Das Gerät funktioniert weiterhin ordnungsmäßig
------------	---

Wenn die Ursache, die den Alarm ausgelöst hat, beseitigt wurde, nimmt das Gerät seinen normalen Betrieb wieder auf, außer bei folgenden Alarmen:

- Alarm Kompressor blockiert (Code "CSd"): Es ist ein Abschalten vom Gerät oder vom Strom erforderlich
- Alarm Abtauen beendet wegen Timeout (Code "dFd"): Es ist das Drücken einer Taste erforderlich.





Fehler

CODE	BEDEUTUNG
Pr1	Fehler Sonde Raumtemperatur Abhilfe: - Prüfen, ob es sich um eine Sonde vom Typ PTC oder NTC handelt; siehe Parameter P0 - Den Anschluss der Sonde an das Gerät prüfen - Die Raumtemperatur prüfen Folgen: - Das Verhalten vom Kompressor hängt von den Parametern C4 und C5 ab - Das Abtauen wird nie aktiviert
Pr2	Fehler Sonde Verdampfer oder Sonde Kondensator Abhilfe: - Wie oben, nur bezogen auf die Sonde vom Verdampfer oder Kondensator Folgen: - Wenn Parameter P4 auf 1 gestellt ist, dauert das Abtauen die mit Parameter d3 festgelegte Zeit - Wenn Parameter P4 auf 1 und Parameter d8 auf 2 oder 3 gestellt ist, funktioniert das Gerät, als ob Parameter d8 auf 0 gestellt wäre - Wenn Parameter P4 auf 2 gestellt ist, wird der Alarm Kondensator überhitzt (Code "COH") nie aktiviert - Wenn Parameter P4 auf 2 gestellt ist, wird der Alarm Kompressor blockiert (Code "CSd") nie aktiviert

Wenn die Ursache, die den Alarm ausgelöst hat, beseitigt wurde, nimmt das Gerät seinen normalen Betrieb wieder auf.

NORMALE TEMPERATUR "-2/+10°C" "-2/+8°C" - TIEFE TEMPERATUR "-24/-12°C"

Anzeigen

LED	BEDEUTUNG
	LED Kompressor LED an: Kompressor ist eingeschaltet LED blinkt: - Die Einstellung vom Setpoint Betrieb läuft - Ein Schutz vom Kompressor wurde ausgelöst
	LED Abtauen LED an: - Abtauen läuft - Das Abtropfen läuft LED blinkt: - Das Abtauen wurde angefordert, aber es wurde ein Schutz vom Kompressor ausgelöst - Das Abtropfen läuft - Das Abtauen wurde angefordert, aber es läuft eine Mindesteinschaltung vom Kompressor
	LED Gebläse vom Verdampfer LED an: Gebläse vom Kompressor ist eingeschaltet LED blinkt: Die Abschaltung vom Gebläse vom Verdampfer läuft
HACCP	HACCP-Alarm im Speicher EVlink
AUX	LED allg. Belegung LED an: - Die Heizdrähte der Tür werden eingeschaltet
	LED energy saving LED an und Display an: Energiesparfunktion läuft LED an und Display aus: Gerät im "Schlafmodus" Eine Taste drücken, um das Display wieder zu aktivieren
	LED Wartung LED an: Der Kompressor muss gewartet werden
°C	LED Grad Celsius LED an: Die Maßeinheit für Temperatur sind Grad Celsius LED blinkt: Die Funktion "Schnellkühlung" oder "Schnellerheizung" läuft
°F	LED Grad Fahrenheit LED an: Die Maßeinheit für Temperatur sind Grad Fahrenheit LED blinkt: Die Funktion "Schnellkühlung" oder "Schnellerheizung" läuft

	ED ON/Standby LED an: Gerät ausgeschaltet (Status "Standby")
---	--

Anzeigen

CODE	BEDEUTUNG
Loc	Tastatur ist blockiert
- - -	Die gewünschte Funktion ist nicht verfügbar

Alarm

CODE	BEDEUTUNG
rtc	Alarm Uhr Abhilfe: Datum, Uhrzeit und Wochentag einstellen
AL	Alarm Mindesttemperatur Abhilfe: - Die Raumtemperatur oder die CPT Temperatur prüfen; siehe Parameter A1 Folgen: - Der Ausgang vom Alarm wird aktiviert
AH	Alarm Höchsttemperatur Abhilfe: - Die Raumtemperatur oder die CPT Temperatur prüfen; siehe Parameter A4 Folgen: - Der Ausgang vom Alarm wird aktiviert
id	Alarm Eingang Mikroschalter Tür Abhilfe: - Prüfen, was die Aktivierung vom Eingang ausgelöst hat; siehe Parameter i0 und i1 Folgen: - Die mit Parameter i0 festgelegte Auswirkung - Der Ausgang vom Alarm wird aktiviert
PF	Alarm Stromausfall Abhilfe: - auf eine Taste tippen - elektrischen Anschluss überprüfen
dFd	Alarm Abtauen beendet wegen Timeout Abhilfe: - Die Funktionstüchtigkeit der Sonde vom Verdampfer prüfen; siehe Parameter d2, d3 und d11 - Eine Taste drücken, um wieder auf normale Anzeige zu schalten Folgen: - Das Gerät funktioniert weiterhin ordnungsmäßig

Wenn die Ursache, die den Alarm ausgelöst hat, beseitigt wurde, nimmt das Gerät seinen normalen Betrieb wieder auf, außer bei folgenden Alarmen:

- Alarm Kompressor blockiert (Code "CSd") und Alarm Hauptschutzschalter (Code "th"): Es ist ein Abschalten vom Gerät oder vom Strom erforderlich.
- Alarm Abtauen beendet wegen Timeout (Code "dFd"): Es ist das Drücken einer Taste erforderlich.

Fehler

CODE	BEDEUTUNG
Pr1	Fehler Sonde Raumtemperatur oder Sonde Zuluft Abhilfe: - Prüfen, ob es sich um eine Sonde vom Typ PTC oder NTC handelt; siehe Parameter P0 - Den Anschluss der Sonde an das Gerät prüfen - Die Raumtemperatur / die CPT Temperatur Prüfen Folgen: - Das Verhalten vom Kompressor hängt von den Parametern C4 und C5 ab - Wenn der Parameter P4 auf 3 gestellt ist, werden die Temperaturregulierung und die Temperaturalarne von der Temperatur der Abluft gesteuert - Das Abtauen wird nie aktiviert - Der Ausgang vom Alarm wird aktiviert - Die Heizdrähte der Tür werden abgeschaltet - Die Heizdrähte für den Betrieb mit neutraler Zone werden abgeschaltet
Pr2	Fehler Sonde Verdampfer Abhilfe: - Wie oben, nur bezogen auf die Sonde vom Verdampfer Folgen: - Wenn Parameter P3 auf 1 gestellt ist, dauert das Abtauen die mit Parameter d3 festgelegte Zeit - Wenn der Parameter P3 auf 1 gestellt ist und der Parameter d8 auf 2 oder 3, funktioniert das Gerät, als ob der Parameter d8 auf 0 gestellt wäre - Wenn Parameter P3 auf 1 oder 2 und Parameter F0 auf 3 oder 4, gestellt ist, funktioniert das Gerät, als ob Parameter

auf 2 gestellt wäre
- Der Ausgang vom Alarm wird aktiviert

Wenn die Ursache, die den Alarm ausgelöst hat, beseitigt wurde, nimmt das Gerät seinen normalen Betrieb wieder auf.

ENTFROSTUNG

DIE ENTEISUNG DER KÜHLSCHRÄNKE IST VÖLLIG AUTOMATISCH.

Die Luftenteisung der Anlagen mit "NORMALE TEMPERATUR 0/+10°C ÷ +2/10°C " erfolgt automatisch jede 6 Stunden. Die Enteisung dauert 20 Minuten.

Die Entfrostung der Anlagen mit "NORMALE TEMPERATUR -2/+10°C ÷ -2/+8°C " ist durch Widerstand erreicht und fällt alle 6 Stunden vor. Die Dauer der Entfrostung wird vom Gerät reguliert.

Die Entfrostung der Anlagen mit "TIEFE TEMPERATUR -24/-12°C" ist auf Heißgas erreicht und fällt alle 6 Stunden Kompressor-Betrieb. Die Dauer der Entfrostung wird vom Gerät reguliert.

Es ist Möglich jedenfalls im jedem Augenblick einen Entfrostungsprozeß in Betrieb setzen durch Drücken der Taste "▲" 5 Sekund lang; die folgende automatische Entfrostung ereignet sich von diesem Moment an nach 6 Stunden bei Anlagen mit "NORMALE TEMPERATUR" und nach 6 Stunden Betrieb des Verdichters bei Anlagen mit "TIEFE TEMPERATUR".

BESCHICKUNG DES PRODUKTES

- Produkt gleichmäßig in den Kühlraum verteilen, damit eine gute Belüftung gestattet wird;
- Vermeiden Sie die Belüftungszonen der an der linken Raumseite angelegten Kühlanlage abzudecken;
- Vermeiden Sie die Lebensmittel, die eine niedrige Konservierungstemperatur benötigen, ins letzte Kühlfach unten rechts einzuordnen;
- Lebensmittel bei der Beladung möglichst mit geeigneten Schutzkunststoffolien verpackt und abgedeckt in den Kühlraum einordnen;
- Keine zu warmen Speisen oder Getränke ins Gerät einführen;
- Bei der Beladung oder Entladung der Lebensmittel Gerätetüren so kurz wie möglich offen lassen;
- Auf dem oberen Rost nur bis zur Stapelmarke lagern;
- Keine Waren unter den unteren Tragschienen ablegen.
- *Modelle Snack*: beim Laden der unteren Schubladen die Ladegrenze nicht überschreiten.

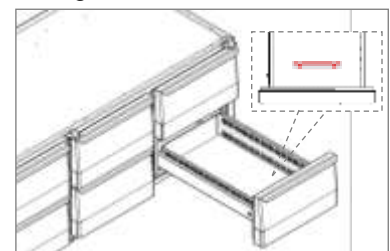
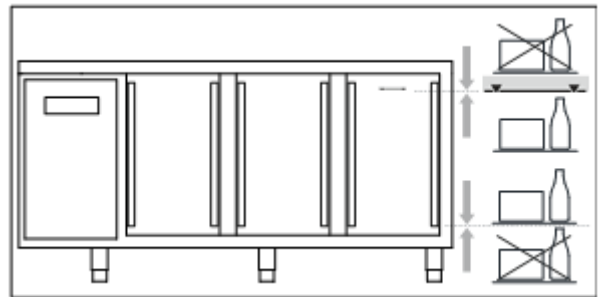

ANHALTEN

Auf jeden Fall und für den Schrank auszuschalten brauch man nur den Hauptschalter 1 auf OFF zu setzen.

ACHTUNG: der Hauptschalter 1 ISOLIERT NICHT die Maschine vom Storm.

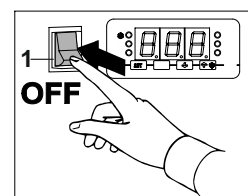

Der Netzschalter auf OFF stellen.

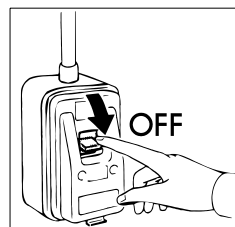

Um die Maschine vom Strom zu isolieren, den Stecker herausziehen.

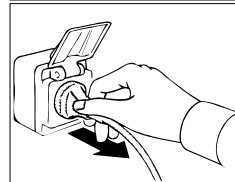

BETRIEBSSTÖRUNGEN

Im Zufall von Anomalien, vorher man die technische Hilfe ruft, prüfen ob:

- der Hauptschalter 1 leuchtet und Strom anwesend ist;
- die eingestellte Temperatur richtig ist;
- die Türe richtig geschlossen sind;
- der Kühlschrank nicht bei Wärmequellen steht;
- der Kondensator sauber ist und der Lüfter funktioniert;
- eine zu dicke Eisschicht die Verdunstungsplatte nicht bedeckt.

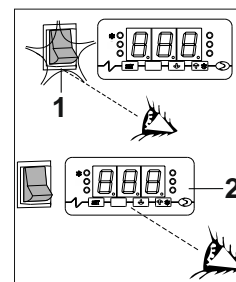

Wenn nach Durchführung dieser Kontrollen die Betriebsstörungen nicht beseitigt sind, wenden Sie sich an Ihren örtlichen Kundendienst. Geben Sie dabei das Modell und die auf dem Typenschild (Geräterückseite) befindliche Typennummer an.

AUFBEWAHREN BEI LÄNGERER NICHTBENUTZUNG

Wenn Sie das Gerät für längere Zeit nicht benutzen wollen, beachten Sie bitte folgende Empfehlungen:

- Stellen Sie den Schalter auf der Schalttafel auf OFF
- Stellen Sie den Netzschalter auf OFF
- Ziehen Sie den Netzstecker und warten Sie, bis das Gerät vollkommen abgetaut ist
- Räumen Sie den Kühlteil aus und reinigen Sie ihn gemäß den Angaben im Kapitel "REINIGUNG"
- Zur Vermeidung von Geruchsbildung sollten Sie die Türen und Schubladen des Gerätes ein wenig offen lassen.

BETRIEBSSTÖRUNGEN

Häufig sind auftretende Betriebsstörungen auf banale Ursachen zurückzuführen, die praktisch immer ohne die Intervention eines spezialisierten Technikers zu beheben sind. Daher ist vor der Signalisierung eines Defektes an den Kundendienst folgendes zu überprüfen:

PROBLEM	MÖGLICHE URSACHEN
Das Gerät schaltet sich nicht ein	Überprüfen, ob der Stecker korrekt in die Steckdose eingesteckt ist
	Überprüfen, ob die Steckdose mit Strom versorgt ist
Die Innentemperatur ist zu hoch	Die Einstellung des Thermostaten überprüfen
	Überprüfen, ob kein Einfluß einer Wärmequelle besteht
	Überprüfen, ob die Tür einwandfrei geschlossen ist
Das Gerät ist zu laut	Die Ausrichtung des Gerätes überprüfen. Eine nicht eben ausgerichtete Position könnte Vibrationen hervorrufen

	Kontrollieren, ob das Gerät nicht in Kontakt mit anderen Geräten oder Teilen ist, die Resonanzen verursachen könnten
Im Kühlschrank könnten unangenehme Gerüche sein	Es könnten Lebensmittel mit besonderen starken Geruch (wie z.B. Käse und Melone), in nicht gut verschlossene Behälter sein Die Innenfläche müssen sauber gemacht werden
Auf dem Gerät bildet sich Kondenswasser	Hohe Raumfeuchtigkeit Die Kühlschranktüren sind nicht gut zugemacht worden

Sollte nach Durchführung der o.g. Überprüfungen der Defekt bestehen bleiben, ist sich an den Technischen Kundendienst zu wenden, wobei folgendes anzugeben ist:

- die Art des Defektes;
- die Modell und die Seriennummer des Gerätes, die dem Typenschild zu entnehmen sind, das sich unter der Bedienblende des Gerätes befindet.

TECHNISCHES DATENBLATT FÜR KÜHLMITTEL

R290

GWP = 3
ODP = 0

❖ Gefahrbestimmung

Flüssiggas – Extrem entzündlich

❖ Erste-Hilfe-Maßnahmen

• Einatmen:

In hoher Konzentration kann es zum Ersticken führen. Mögliche Symptome sind Mobilitäts- oder Bewusstseinsverlust. Die Opfer können sich nicht bewusst sein, dass sie ersticken. In geringer Konzentration kann es einschläfernd wirken. Mögliche Symptome sind Schwindel, Kopfschmerzen, Übelkeit und Verlust der Koordination. Bringen Sie das Opfer in einen nicht kontaminierten Bereich und legen Sie ihm eine Beatmungsmaske an. Sorgen Sie dafür, dass der Patient liegen bleibt und ihm warm ist. Rufen Sie einen Arzt. Setzen Sie die künstliche Beatmung bei Atemstillstand fort.

• Haut- und Augenkontakt:

Bei Austreten mindestens 15 Minuten Ausspülen

• Verschlucken:

Wenig wahrscheinlicher Expositionsweg

❖ Umweltinformationen

Es sind keine Umweltschäden bekannt, die von diesem Produkt verursacht werden

ELEKTRISCHES SCHALTBILD

Sie finden den Schaltplan auf der letzten Seite des Handbuchs.

Pos	BESCHREIBUNG	Pos	BESCHREIBUNG
1	KOMPRESSOR	20C	WIDERSTAND ANTIKONDENS TÜR
2	KONDENSATOR	21	WIDERSTAND ENTFROSTUNG
3	KLEMMENBRETT	22	WIDERSTAND SCHÜSSELBODEN
6	HAUPTSCHALTER	44	RELAY
8	STECKER	69	ERDUNGSKLEMME
9	VERDAMPFERVENTILATOR	75	ELEKTROVENTIL
12	ELEKTROVENTIL ENTFROSTUNG	88	DIGITALER THERMOREGLER
20	WIDERSTAND ANTIKONDENS TÜR	90	DIGITALER THERMOREGLER
20A	WIDERSTAND ANTIKONDENS TÜR	102	SICHERHEITSTHERMOSTAT
20B	WIDERSTAND ANTIKONDENS TÜR		

INDEX

INFORMATIONS DE SECURITE	2
PRESCRIPTIONS DE SECURITE.....	2
DESCRIPTION DE LA MACHINE	4
PLAQUETTE D'IDENTIFICATION	4
DIMENSIONS D'ENCOMBREMENT	5
MISE EN OEUVRE ET INSTALLATION	7
NETTOYAGE ET ENTRETIEN GENERAL	8
L'ENTRETIEN DE APPAREIL EN L'ACIER INOX.....	8
L'ENTRETIEN DE ARMOIRES EN VX-PET.....	10
DÉMOLITION ET ÉLIMINATION DES DÉCHETS.....	10
NOTES GENERALES A LA REMISE	11
ACCESSOIRES	11
PRESCRIPTIONS HACCP.....	11
CARACTERISTIQUES TECHNIQUES.....	12
TABLEAUX DE COMMANDE.....	13
MISE EN MARCHÉ ET FONCTIONNEMENT	13
BLOCAGE/DEBLOCAGE DU CLAVIER	13
POINT DE CONSIGNE ET PARAMETRES DE CONFIGURATION.....	14
GESTION HUMIDITÉ (<i>seulement sur appareils Pastry & Bakery</i>)	21
ALARMS.....	21
DEGIVRAGE.....	24
CHARGEMENT DU PRODUIT	24
ARRET	24
IRREGULARITES DE FONCTIONNEMENT	25
INTERRUPTIONS D'USAGE	25
PROBLEMES DE FONCTIONNEMENT.....	25
FICHE TECHNIQUE DU REFRIGERANT	26

INFORMATIONS DE SECURITE

MISE EN GARDE: Cette armoire contient du réfrigérant hydrocarbures (R290).

DANGER: Risque de feu ou d'explosion. Le frigorigène utilisé est inflammable. Ne pas utiliser des appareils mécaniques pour dégivrer le réfrigérateur. Ne pas perforer la tubulure de frigorigène.

DANGER: Risque de feu ou d'explosion. Le frigorigène utilisé est inflammable. Les réparations doivent être effectuées seulement par un technicien qualifié. Ne pas perforer la tubulure de frigorigène.

ATTENTION: Risque de feu ou d'explosion. Le frigorigène utilisé est inflammable. Consulter le manuel de réparations ou le manuel utilisateur avant de tenter d'intervenir sur cet appareil. Toutes les mesures de sécurité doivent être respectées.

ATTENTION: Risque de feu ou d'explosion. Mettre au rebut conformément aux règlements fédéraux ou locaux. Le frigorigène utilisé est inflammable.

ATTENTION: Risque de feu ou d'explosion en cas de perforation de la tubulure de frigorigène; suivre soigneusement les consignes de manutention. Le frigorigène utilisé est inflammable.

ATTENTION: ne pas conserver de substances explosives comme des bombes aérosol avec un gaz propulseur inflammable à l'intérieur de cet appareil.

ATTENTION: Éviter toute obstruction des ouvertures de ventilation dans la pièce où l'armoire est située ou sur l'armoire elle-même.



Signal de danger d'inflammabilité en raison de la présence de fluide frigorigène inflammable (R290 ou R600a).

Les instructions sont disponibles sur le site Internet www.sagispa.it

PRESCRIPTIONS DE SECURITE

Les appareils sont équipés d'un câble d'alimentation avec prise.

ATTENTION: avant n'importe quelle opération d'entretien ou nettoyage il faut isoler l'appareil du courant:

– Portez l'interrupteur général en position OFF.

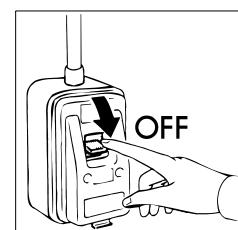

– Enlevez la fiche. Le retrait de la fiche doit être tel que l'opérateur puisse vérifier sa désactivation de chaque point de travail.

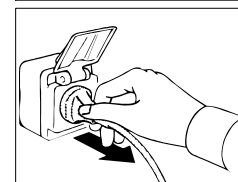

ATTENTION: n'utilisez pas des fiches ou des prises dépourvues de mise à terre.

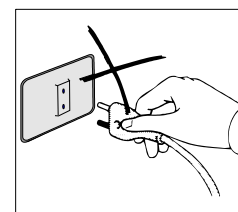

La prise de courant doit être pourvue de MISE A TERRE.

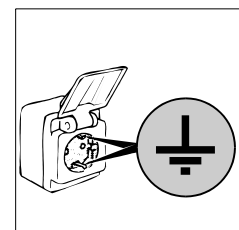

ATTENTION: n'utilisez pas d'adaptateurs ou de ralonges pour la jonction au réseau.

ATTENTION: en cas de câble d'alimentation endommagé, le faire remplacer par un service assistance ou par du personnel qualifié.

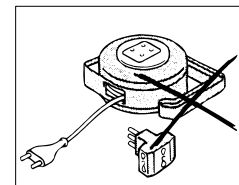

Le nettoyage et l'entretien de l'installation réfrigérante et de la région des compresseurs nécessite de l'intervention d'un technicien spécialisé et autorisé, pour cette raison elle ne peut être effectuée par du personnel non qualifié.



Pour des interventions d'entretien ou en cas d'anomalies débranchez complètement l'appareil; demandez l'intervention du SERVICE APRES-VENTE à un centre autorisé et l'emploi de pièces de rechange originales.

La faute de ci-dessus peut compromettre l'état de sécurité des appareils.

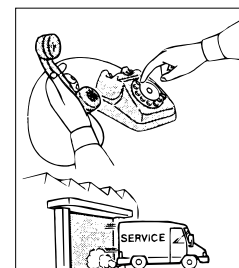

ATTENTION: après la mise en service, attendez le temps nécessaire pour atteindre la température réglée avant d'insérer les aliments à conserver.

Couvrez toujours les aliments avec les pellicules spéciales, avant de les mettre dans les appareils.

ATTENTION: N'introduisez pas de boissons ou d'aliments chauds.

ATTENTION: ne faites pas de ménage autour de l'armoire frigorifique quand la porte est ouverte.

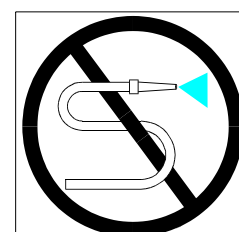

Ne pas laver l'appareillage avec des jets d'eau directs et à une pression élevée.

ATTENTION: n'utilisez pas de substances à base de chlore (eau de javel, acide muriatique, ecc.) ou de toute manière toxiques pour le nettoyage ou dans les parages des réfrigérateurs.

ATTENTION: ne pas utiliser de dispositifs mécaniques ni d'autres moyens pour accélérer le processus de dégivrage différents que ceux recommandés par le constructeur.

ATTENTION: ne pas utiliser d'appareils électriques à l'intérieur des compartiments.

L'équipement est conçu pour un niveau de pression acoustique inférieur à 70db(A).



DESCRIPTION DE LA MACHINE

Cet appareil est destiné à être utilisé pour la réfrigération et la conservation des aliments. Toute autre utilisation est considérée comme étant impropre.

ATTENTION: les appareils ne sont pas prévus pour être installés à l'extérieur et/ou en endroits soumis à l'action d'agents atmosphériques. Ne pas utiliser dans des atmosphères potentiellement explosives.

Le fabricant décline toute responsabilité en cas d'utilisations non consenties de l'appareil.

Les comptoirs sont dotés sur leur partie supérieure d'un plan de travail que l'on peut réaliser sur demande avec rehausse; de même, des comptoirs sans plan de travail, mais avec de similaires capacités réfrigérantes sont disponibles.

Les commandes sont à thermorégulateur digital et interrupteur général.

Le groupe du moteur est logé sur la gauche du comptoir, dans un emplacement prévu à cet effet.

L'évaporateur est situé à l'intérieur de l'emplacement du moteur, un pour chaque emplacement, et il est protégé par des tôles prévues.

La ventilation interne s'effectue à l'aide de ventilateurs tangentiels protégés et situés au-dessus de l'évaporateur.

L'appareil est doté d'évaporation automatique de la condensation.

Les parties en contact avec le produit sont réalisées en acier inox ou revêtues de matière plastique atoxique.

En cas d'arrêt de la machine assurer une bonne ventilation, une température comprise entre -20°C+50°C, une humidité relative comprise entre 30% et 80% et une atmosphère sèche et non poussiéreuse.

PLAQUETTE D'IDENTIFICATION

La plaquette signalétique est positionnée sur l'appareil; elle fournit une série d'indications importantes sur les caractéristiques techniques et constructives du produit.

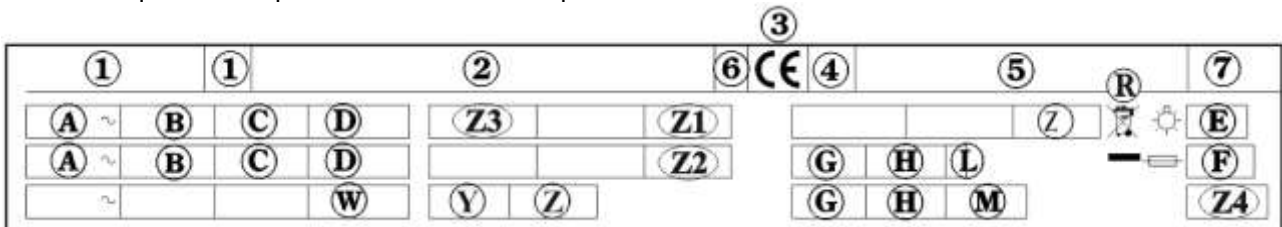

Contenu des champs de la plaquette de l'appareil

- | | |
|--|--|
| <ul style="list-style-type: none"> 1) MODÈLE 2) ENTREPRISE DE FABRICATION ET ADRESSE 3) SIGLE MARQUAGE CE 4) ANNÉE DE FABRICATION 5) N° DE MATRICULE 6) CLASSE D'ISOLEMENT ÉLECTRIQUE 7) CLASSE DE PROTECTION ÉLECTRIQUE A) TENSION D'ALIMENTATION ÉLECTRIQUE B) INTENSITÉ DU COURANT ÉLECTRIQUE C) FRÉQUENCE D'ALIMENTATION ÉLECTRIQUE D) PUISSANCE NOMINALE E) PUISSANCE TOTALE LAMPES | <ul style="list-style-type: none"> F) COURANT FUSIBLE G) TYPE GAS RÉFRIGÉRANT H) QUANTITÉ GAS RÉFRIGÉRANT L) CLASSE DE TEMPÉRATURE INSTALLATION FRIGORIFIQUE R) SYMBOLE DEEE W) PUISSANCE ÉLÉMENTS RÉCHAUFFANTS Z1) VOLUME NET (RSV) Z2) FLUID FOAMING Z3) TEMPÉRATURE DE FONCTIONNEMENT Z4) GWP |
|--|--|

Classe climatique*	Température ambiante
3 (SN)	+10°C ---> +32°C
4 (N)	+16°C ---> +32°C
4+ (ST)	+16°C ---> +38°C
4+ (SN-ST)	+10°C ---> +38°C
5 (T)	+16°C ---> +43°C
5 (SN-T)	+10°C ---> +43°C

(*)La classe climatique indique la température ambiante pour laquelle l'équipement est capable de fonctionner.

DIMENSIONS D'ENCOMBREMENT

Se référer aux dimensions de votre appareil.

- *Modèles prof.600*

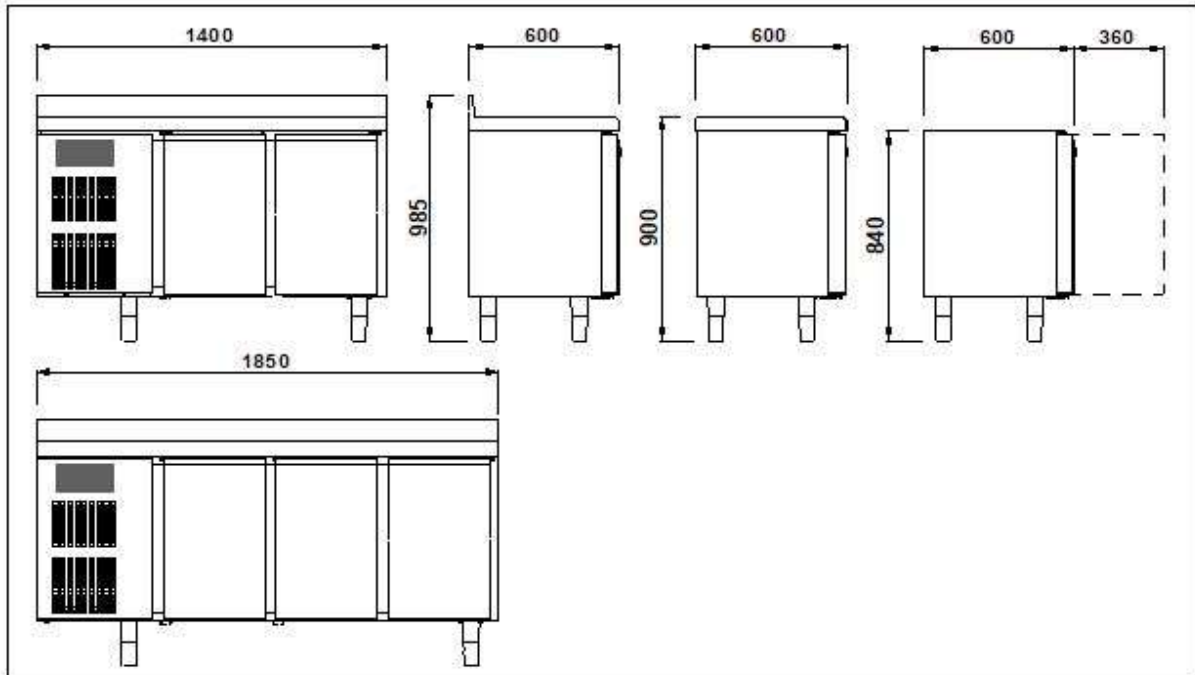

- *Modèles prof.700*

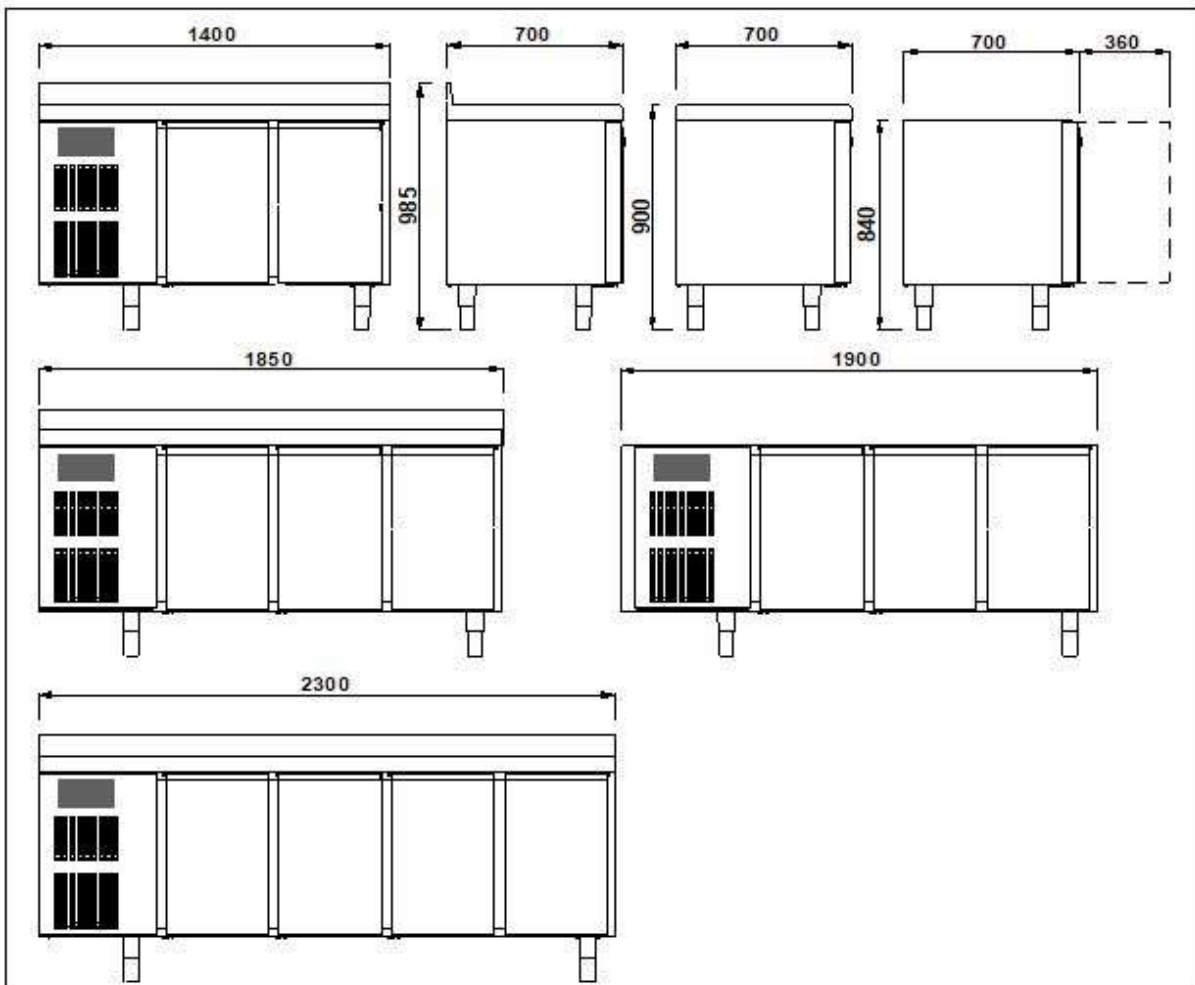

- *Modèles snack*

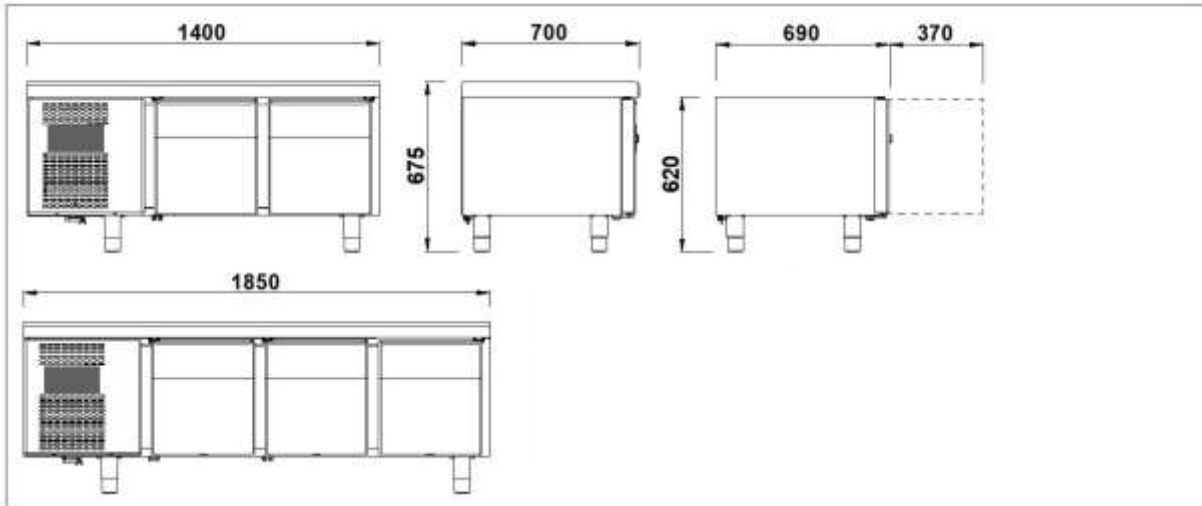

- *Modèles pastry & bakery*

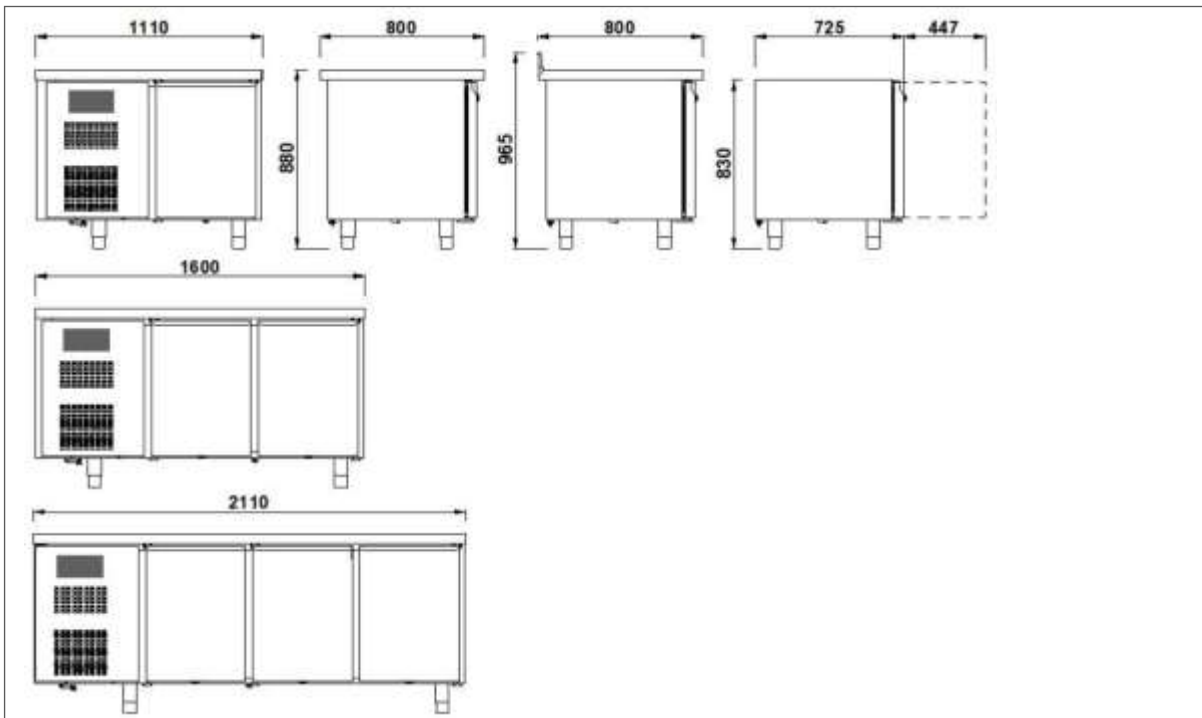

- *Modèles pizza*

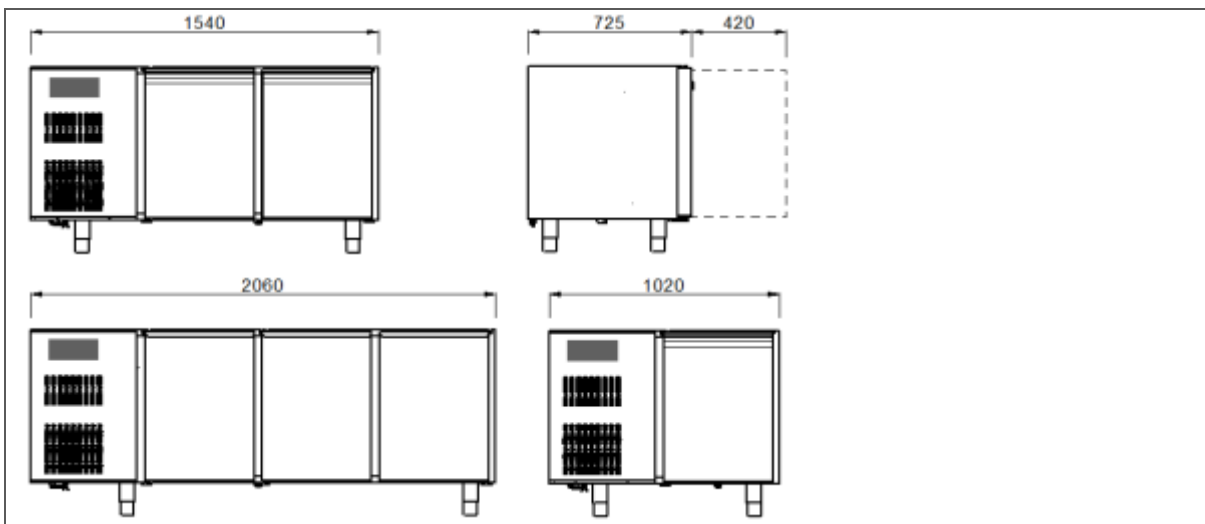

MISE EN OEUVRE ET INSTALLATION

Les appareils sont toujours livrés sur palette et conditionnés dans un carton de protection.

Lors de la réception de la marchandise, après avoir déballé les cartons, si l'on constate des dommages ou des éléments manquants, procéder comme détaillé dans le chapitre "NOTES GENERALES A LA LIVRAISON".

Les opérations de mise en œuvre et d'installation doivent être effectuées par du personnel spécialisé.



Enlever la boîte d'emballage en prenant soin à ne pas endommager les surfaces de l'appareil.

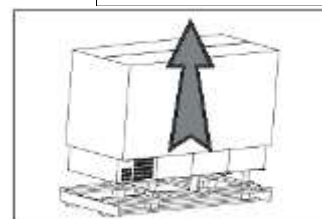

ATTENTION: les éléments de l'emballage (sachets en plastiques, polystyrène expansé, clous, etc...) doivent être stockés hors portée des enfants car ce sont de potentielles sources de danger.

Avec un chariot à fourches, lever l'appareil et le transporter sur le lieu de l'installation, en prenant soin à bien équilibrer le chargement.

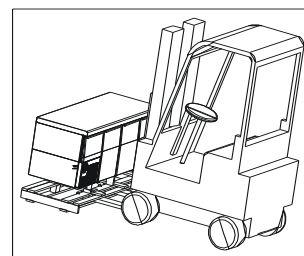

ATTENTION: tant pour le placement sur le lieu d'installation, que pour des déplacements futurs, ne jamais pousser ou traîner l'appareil car ce dernier peut basculer et ont peut donc provoquer des dommages à des parties mêmes de l'appareil.

ATTENTION: ne jamais positionner l'appareil dans le voisinage de sources de chaleur ou dans des lieux ayant des températures élevées; cette situation peut provoquer une mineure performance de l'appareil et une excessive sollicitation de l'installation de réfrigération.



Placez l'appareil sur son emplacement final.

Assurez-vous que la pièce est suffisamment aérée. Ne pas allouer l'équipement dans des environnements où la température est supérieure à la classe climatique déclarée.

Enlever la pellicule de protection du produit.

Cette opération peut provoquer des décharges électriques déplaisantes, même si elles ne sont pas dangereuses (électricité statique). On peut réduire ou éliminer l'inconvénient en maintenant une main toujours en contact avec l'appareil ou en raccordant à la terre la carcasse extérieure.

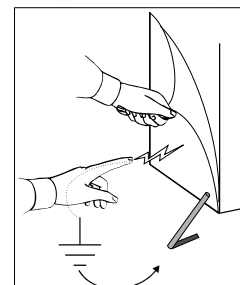

A ce point, on peut procéder au nivellement de l'appareil en agissant sur les pieds.

Niveler l'appareil en le maintenant légèrement incliné vers l'arrière afin de faciliter la fermeture optimale des portes.

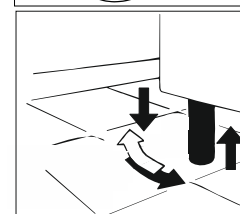

Nettoyer avec de l'eau tiède et du savon neutre (voir le chapitre "NETTOYAGE") et installer les éventuels accessoires.

Vérifier que la tension de secteur correspond à celle indiquée sur la plaquette des caractéristiques techniques de l'appareil.

ATTENTION: vérifier que la prise secteur est prédisposée de mise à la terre, sinon la modifier.

Connecter la fiche à la prise secteur.

L'appareil doit être englobé dans un système équipotentiel dont l'efficacité doit être vérifiée conformément à la normalisation en vigueur. On effectue la connexion par le biais d'une vis estampillée du sigle "Equipotentiel" située dans la zone des compresseurs.

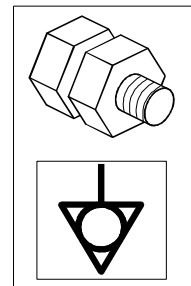

Maintenant, les opérations de mise en œuvre sont terminées.

NETTOYAGE ET ENTRETIEN GENERAL

Pour un rendement constant du réfrigérateur il est recommandé d'effectuer les opérations de nettoyage et entretien général.

Avant de commencer les opérations, procédez comme ci-dessous:

- tournez l'interrupteur du réseau en position OFF
- tirez la fiche de la prise et attendez le complet dégivrage de l'appareil.

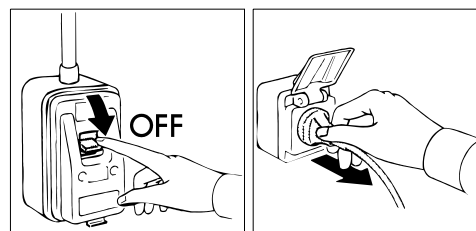

A l'aide d'un aspirateur, d'un pinceau ou d'une brosse non métallique, nettoyer soigneusement le groupe réfrigérant et en particulier la batterie à ailettes.

ATTENTION: le nettoyage et l'entretien de l'installation de réfrigération et de la zone compresseurs nécessite l'intervention d'un technicien qualifié et agréé; ils ne peuvent donc en aucune manière être effectués par du personnel non idoine.

Nettoyer les surfaces externes et internes de l'appareil en suivant les indications reportées dans le paragraphe nettoyage journalier.

Rincer abondamment avec de l'eau et essuyer.

Les opérations d'entretien et de nettoyage général sont ainsi accomplies.

L'ENTRETIEN DE L'APPAREIL EN L'ACIER INOX

NETTOYAGE JOURNALIER

Pour garantir une parfaite hygiène et une parfaite conservation de l'appareil il est conseillé d'effectuer ordinairement et/ou quotidiennement les opérations de nettoyage suivante:

1. Nettoyer soigneusement les surfaces de l'appareil avec une éponge douce mouillée avec de l'eau et du détergent neutre, essorée, uniquement dans le sens du satinage.
2. Le détergent ne doit pas contenir de chlore et ne doit pas être abrasif.
 - 2.a Les détergents conseillés sont ceux de type:
 - Détergent désinfectant à action combinée;
(contenant des tensioactifs non ioniques, benzalconique chlorure, substances chélatantes et pH tampon)

- Détergent pour laboratoire, neutre, pour lavage Manuel; (contenant des tensioactifs anioniques et non ioniques)
- Dégraissant pour milieux alimentaires; (contenant des tensioactifs anioniques et EDTA)

3. Avant l'utilisation diluer éventuellement les détergents suivant les instructions reportées sur l'étiquette.
4. Laisser agir les détergents pendant au moins 5 minutes.
5. Rincer soigneusement les parois du réfrigérateur avec une éponge passée plusieurs fois sous l'eau courante.
6. Essuyer soigneusement avec une éponge propre.

ATTENTION: n'utilisez absolument pas d'outils ou objets qui peuvent produire des écorchures et par conséquent la formation de rouille.

TACHES DE NOURRITURE ET RESTES RACORNIS

En cas de présence dans le réfrigérateur de taches ou de résidus alimentaires, laver avec de l'eau et enlever celles-ci avant qu'elles puissent s'incruster.

Si les résidus se sont déjà incrustés, procéder de la façon suivante:

1. Utiliser une éponge douce mouillée avec de l'eau tiède et du détergent neutre (vous pouvez utiliser ceux prévus pour le nettoyage quotidien, à plus haute concentration parmi celles prévues sur les étiquettes).
2. Humidifier le résidu incrusté de façon à le maintenir humide pendant au moins 30 minutes en passant toutes les 5 minutes l'éponge mouillée avec l'eau et le détergent sur la partie endurcie.
3. A la fin du trempage, enlever le résidu avec l'éponge toujours mouillée avec l'eau et le détergent neutre.
4. Si nécessaire, recourir à une spatule en bois ou à une paille fine en acier inox, en faisant attention à ne pas endommager la surface du appareil.
5. A la fin du processus il est conseillé un cycle de nettoyage quotidien de toutes les surfaces internes du appareil.
6. Une fois le nettoyage terminé, rincer soigneusement avec une éponge rincée sous l'eau courante.
7. Essuyer soigneusement avec une éponge propre.

Le sol autour et sous les appareils doit aussi être tenu propre et en parfaite hygiène. Lavez avec eau et savon ou du détergent neutre.

Protéger la carrosserie en y appliquant de la cire au silicone.

CONSEILS UTILES POUR L'ENTRETIEN DE L'ACIER INOX

Pour le nettoyage et l'entretien des parties en acier inox, tenez-vous à ce qui est spécifié ci de suite, tenant compte que la première et fondamentale règle est de garantir la non toxicité et le maximum d'hygiène des produits traités.

L'acier inox a une fine pellicule d'oxide qui empêche la formation de rouille.

Il y a des substances ou détergents qui toutefois peuvent détruire ou manger cette couche et faire naître des corrosions.

Avant d'utiliser n'importe quel produit détergent informez-vous toujours chez votre fournisseur de confiance quel est le produit détergent neutre plus indiqué ne produisant pas de corrosions sur l'acier.

En cas d'écorchures sur les surfaces il est nécessaire de les polir avec de la laine d'ACIER INOX très fine ou une éponge abrasive synthétique fibreuse en frottant dans le sens du satinage.

ATTENTION: pour le nettoyage de l'ACIER INOX n'utilisez jamais des pailles de fer et ne les laissez pas posées dessus car des légers dépôts ferreux pourraient rester sur les surfaces et provoquer des formations de rouille par contamination et compromettre l'hygiène.

L'ENTRETIEN DE ARMOIRES EN VX-PET

Pour garantir une parfaite hygiène et une parfaite conservation de l'appareil il est conseillé d'effectuer ordinairement et/ou quotidiennement les opérations de nettoyage.

En cas de présence de tâches d'aliments ou résidus sur la surface externe, rincer avec de l'eau et enlever avant que celles-ci ne puissent durcir.

Si les résidus sont déjà durcis utiliser une éponge douce trempée dans de la térébenthine ou de l'alcool dénaturé.

En cas de présence de tâches d'aliments ou résidus sur la surface interne, utiliser du vinaigre blanc bouillant ou de l'alcool dénaturé en utilisant un chiffon doux pour le nettoyage.

Nettoyer dans le sens du satinage.

Il est conseillé d'effectuer un cycle de nettoyage journalier de toutes les surfaces internes de l'appareil.

Éviter d'utiliser des crèmes abrasives ou des éponges métalliques en acier inox, de l'acétone, de la trichloréthylène et de l'ammoniac.

Une fois le nettoyage terminé, rincer soigneusement avec une éponge rincée sous l'eau courante.

Essuyer soigneusement avec une éponge propre.

Le sol autour et sous les armoires doit aussi être tenu propre et en parfaite hygiène.

Lavez avec eau et savon ou du détergent neutre.

DÉMOLITION ET ÉLIMINATION DES DÉCHETS

STOCKAGE DES DÉCHETS

A la fin du cycle de vie du produit, éviter de jeter l'appareil dans l'environnement. Les portes devront être démontées avant la destruction de l'appareil.

Les déchets spéciaux peuvent être stockés provisoirement avant de les soumettre à un traitement et/ou stockage définitifs. Dans tous les cas, il est impératif d'observer les lois en vigueur pour la protection de l'environnement du pays de destination de l'appareil.

PROCÉDURE INHÉRENTE AUX OPÉRATIONS DE DÉMONTAGE DE L'APPAREIL

Étant donné qu'il existe à ce propos une législation différente dans chaque pays, il est impératif d'observer les contraintes imposées par les lois et les organismes relatifs du pays où aura lieu la destruction.

En règle générale, il faut consigner l'armoire frigorifique à un centre spécialisé pour le collectage de la ferraille/démolition.

Démonter l'armoire frigorifique en regroupant les composants en fonction de leur nature chimique. Se rappeler que le compresseur contient de l'huile lubrifiante et du fluide frigorigène qui peuvent être récupérés et réutilisés et que les composants de l'armoire frigorifiques sont des déchets spéciaux (pouvant toutefois être éliminés comme les ordures ménagères).

Rendre l'appareil inutilisable en retirant le câble d'alimentation et tout dispositif de verrouillage des compartiments pour que personne ne puisse s'y enfermer par mégarde.

DANS TOUS LES CAS, LE DÉMONTAGE DOIT ÊTRE EFFECTUÉ PAR UN PERSONNEL QUALIFIÉ.

SECURITE POUR L'ELIMINATION DES DECHETS D'EQUIPEMENTS ELECTRIQUES ET ELECTRONIQUES (DIRECTIVE DEEE 2002/96/CE)

Ne pas évacuer les matières polluantes dans l'atmosphère. Effectuer l'élimination dans le respect des lois en vigueur en la matière.

En référence à la Directive DEEE 2002/96/CE (déchets d'équipements électriques et électroniques), l'utilisateur, lorsqu'il veut éliminer les appareils, doit les transporter vers des points de collecte agréés, ou les remettre encore installés au vendeur lors d'un nouvel achat.

Tous les appareils qui doivent être éliminés conformément à la Directive DEEE 2002/96/CE, sont marqués

d'un symbole spécial .

L'évacuation abusive des déchets d'équipements électriques et électroniques est passible de sanctions conformément aux lois en vigueur dans le territoire où l'infraction a été commise.

Les déchets des équipements électriques et électroniques peuvent contenir des substances dangereuses avec des effets potentiellement nocifs sur l'environnement et sur la santé des personnes. L'évacuation et l'élimination doivent être faites de façon correcte.

NOTES GENERALES A LA REMISE

A la remise, vérifiez que l'emballage soit intact et ne soit pas endommagé par le transport.

Après avoir déballé la l'armoire frigorifique, assurez-vous d'avoir reçu toutes les parties, et que les caractéristiques et l'état correspondent aux spécifications de la commande.

Si ce n'est pas le cas, mettez-vous immédiatement en contact avec votre revendeur.

Nous nous complimentons avec vous pour votre excellent choix et nous vous souhaitons de pouvoir utiliser au mieux vos armoires frigorifiques en suivant les instructions et les précautions nécessaires contenus dans ce manuel.

Nous vous rappelons que toute reproduction du présent manuel est interdite et que grâce à une recherche continue d'innovations et de qualité technologique les caractéristiques ici reportées pourraient changer sans préavis.

ACCESSOIRES

Sur demande l'appareil peut être équipé des accessoires suivants (*vea el catálogo-general*).

PRESCRIPTIONS HACCP

ATTENTION: Légumes crus, oeufs et volailles **NE** peuvent pas être conservés dans les mêmes compartiments réfrigérés. La volaille doit être conservée dans des compartiments réfrigérés spéciaux.

ATTENTION: Eviter de conserver des aliments qui aient une température y compris entre 10°C et 60°C. Utiliser des appareil spéciaux (cellules mixtes de refroidissement de température) pour réduire la température au cœur de l'aliment.

ATTENTION: En sortant les aliments du frigo il faut contrôler la date de péremption sur les emballages et prendre ceux dont la date est la plus proche. Si l'on relève un aliment périmé il faut le sortir du frigo et le signaler au responsable de la Société pour laquelle vous travaillez.

ATTENTION: Les aliments facilement périssables doivent être enlevés du milieu réfrigéré le plus tard possible de façon à être exposé à la température de la pièce le temps nécessaire.

ATTENTION: Ne jamais recongeler les aliments préalablement décongelés.

ATTENTION: Numérotez les outils et contrôlez deux fois par jour la température relevée en enregistrant les valeurs sur la fiche spéciale à garder pendant 24 mois.

ATTENTION: D'éventuelles interruptions d'électricité peuvent être effectuées en contrôlant le temps d'arrêt à travers une horloge électrique afin d'éliminer les aliments qui pourraient se détériorés.

Température maximale admises pour les aliments

Aliment	Température normale de stockage (°C)	Température maximale de transport (°C)
Lait frais pasteurisé	0÷+4	9
Crème fraîche	0÷+4	9
Yoghurt, ricotta et fromages frais	0÷+2	9
Produit de la pêche sous glace	0÷+2	0÷+4
Viande de boeuf et de porc	0÷+3	10
Volaille	0÷+4	8
Lapin	0÷+2	8
Gibier petit	0÷+2	8
Gibier grand	0÷+2	8
Abats	0÷+3	8
Surgelés	-23÷-24	-18
Glaces confectionnées	-18÷-20	-18
Fruits et légumes	0÷+4	normale

CARACTERISTIQUES TECHNIQUES

Dans les dernières page du manuel: caracteristiques techniques.

TABLEAUX DE COMMANDE

Tous les frigos sont dotés d'un interrupteur général et d'un thermostat :

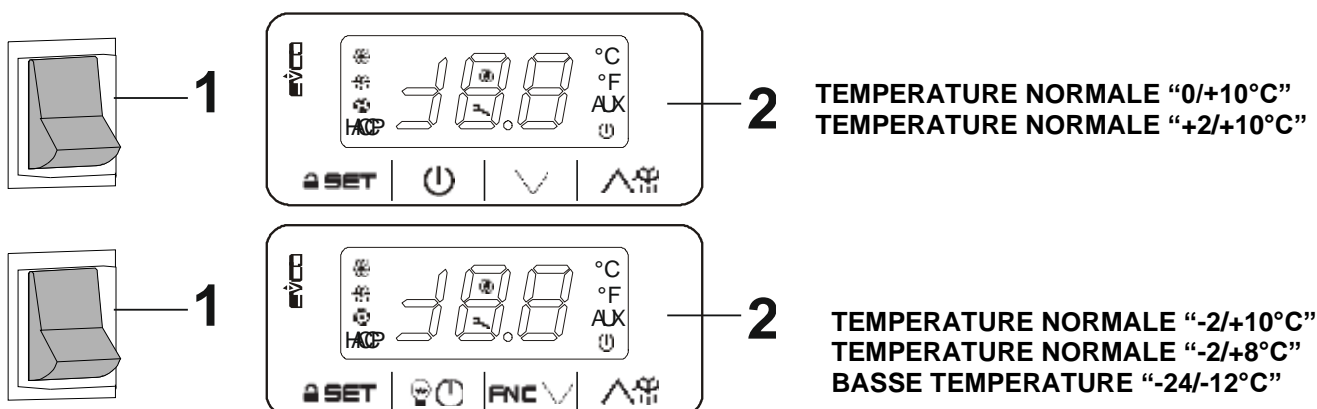

MISE EN MARCHÉ ET FONCTIONNEMENT

Pour le démarrage de l'appareil, procéder comme suit :

- Branchez la fiche dans sa prise ;
- Mettre sous tension l'appareil en positionnant en ON ;

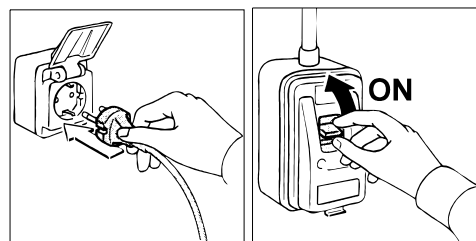

- Appuyer sur l'interrupteur général (1) ; le témoin vert de l'interrupteur général s'allume ;
- Maintenant, on peut programmer la température de fonctionnement à l'aide du thermostat (2).

Après le délai nécessaire au refroidissement, vérifier que l'affichage du thermostat (2) de la température interne des appareils correspond à la température programmée.

BLOCAGE/DEBLOCAGE DU CLAVIER

Pour bloquer le clavier :

- S'assurer qu'aucune procédure n'est en cours
- Ne pas opérer pendant 30s : l'afficheur indique "Loc" pendant 1s et le clavier se bloque automatiquement.

Si le clavier est bloqué, il sera impossible :

- d'allumer/éteindre le dispositif
- d'afficher la température relevée par les sondes
- d'activer le dégivrage en modalité manuelle
- de sélectionner le point de consigne de fonctionnement

Ces opérations provoquent l'affichage de l'étiquette "Loc" pendant 1s.





Pour débloquer le clavier :

- Toucher une touche enfoncée pendant 1s : l'afficheur indique "UnL" pendant 1s.

POINT DE CONSIGNE ET PARAMETRES DE CONFIGURATION

TEMPERATURE NORMALE "0/+10°C" "+2/+10°C"

Sélection du point de consigne de fonctionnement

- S'assurer que le clavier n'est pas bloqué et qu'aucune procédure n'est en cours
- Toucher la touche **SET** a DEL  se met à clignoter
- Toucher la touche  ou la touche  dans un délai de 15 s ; voir également les paramètres r1 et r2
- Toucher la touche **SET** ou ne pas opérer pendant 15s : la DEL  s'éteint, après quoi le dispositif quitte la procédure.

Pour quitter la procédure prématurément:

- Toucher la touche  (les éventuelles modifications ne seront pas enregistrées)



On peut également sélectionner le point de consigne de fonctionnement à travers le paramètre **SP**.

Points de consigne



PARAM.	MIN.	MAS.	U.M.	POINT DE CONSIGNE
r1	r2		°C/°F (1)	point de consigne de fonctionnement ; voir également r0 et r12

Programmation des paramètres de configuration

Pour accéder à la procédure:

- S'assurer qu'aucune procédure n'est en cours
- Toucher la touche enfoncée **SET** pendant 4 s : l'afficheur indique "PA"
- Enfoncer puis relâcher la touche **SET**
- Toucher la touche  ou la touche  dans un délai de 15 s pour sélectionner la valeur établie avec les paramètres "PAS" (pour la sélection nominale, le paramètre est saisi à -19°)
- Toucher la touche **SET** ou ne pas opérer pendant 15s : l'afficheur indique "SP"

Pour sélectionner un paramètre:

- Toucher la touche  ou la touche 

Pour modifier un paramètre:

- Toucher la touche **SET**
- Toucher la touche  ou la touche  dans un délai de 15 s
- Toucher la touche **SET** ou ne pas opérer pendant 15s

Pour quitter la procédure:

- Toucher la touche **SET** enfoncée pendant 4 s ou ne pas opérer pendant 60 s (les éventuelles modifications seront enregistrées)

Paramètres de configuration

PARAM.	MIN.	MAS.	U.M.	POINT DE CONSIGNE DE FONCTIONNEMENT
SP	r1	r2	°C/°F (1)	point de consigne de fonctionnement ; voir également r0 et r12

PARAM.	MIN.	MAS.	U.M.	ENTRÉES ANALOGIQUES
CA1	-25	25	°C/°F (1)	offset sonde ambiante
CA2	-25	25	°C/°F (1)	si P4 = 1, offset sonde évaporateur si P4 = 2, offset sonde condensateur
P0	0	1	-	type de sonde 0=PTC 1=NTC
P1	0	1	-	point décimal degré Celsius (durant le fonctionnement normal) 1=OUI
P2	0	1	-	unité de mesure température (2) 0=°C (degré Celsius ; la résolution dépend du paramètre P1) 1=°F (degré Fahrenheit ; la résolution est de 1 °F)
P4	0	2	-	fonction de la deuxième entrée 0=entrée numérique (micro-interrupteur porte multifonction) 1=entrée analogique (sonde évaporateur) 2=entrée analogique (sonde condensateur)
P5	0	2	-	grandeur affichée durant le fonctionnement normal 0=température ambiante 1=point de consigne de fonctionnement 2= si P4 = 0, " - -" si P4 = 1, température de l'évaporateur si P4 = 2, température du condensateur
P8	0	250	0,1s	retard de l'affichage de la variation des températures relevées par les sondes

PARAM.	MIN.	MAS.	U.M.	RÉGULATEUR PRINCIPAL
r0	0.1	15	°C/°F (1)	différentiel du point de consigne de fonctionnement ; voir également r12
r1	-99	r2	°C/°F (1)	point de consigne minimum de fonctionnement
r2	r1	99	°C/°F (1)	point de consigne maximum de fonctionnement
r4	0	99	°C/°F (1)	augmentation du point de consigne de fonctionnement durant la fonction "energy saving" ; voir également i0, i10 et HE2
r5	0	1	-	fonctionnement pour le froid ou pour le chaud (3) 0=pour le froid 1=pour le chaud

r12	0	1	-	type de différentiel du point de consigne de fonctionnement 0=asymétrique 1=symétrique
-----	---	---	---	--

PARAM.	MIN.	MAS.	U.M.	PROTECTIONS DU COMPRESSEUR
C0	0	240	min	retard de l'allumage du compresseur à compter de la mise sous tension du dispositif (4)
C2	0	240	min	durée minimale de l'extinction du compresseur (5)
C3	0	240	s	durée minimale de l'allumage du compresseur (5)
C4	0	240	min	durée de l'extinction du compresseur durant l'erreur sonde ambiante (code "Pr1"); voir également C5
C5	0	240	min	durée de l'allumage du compresseur durant l'erreur sonde ambiante (code "Pr1"); voir également C4
C6	0	199	°C/°F (1)	température du condensateur au-delà de laquelle l'alarme du condensateur surchauffé se déclenche (code "COH") (6)
C7	0	199	°C/°F (1)	température du condensateur au-delà de laquelle l'alarme du compresseur bloqué se déclenche (code "CSd")
C8	0	15	min	retard alarme compresseur bloqué (code "CSd") (7)

PARAM.	MIN.	MAS.	U.M.	DÉGIVRAGE
d0	0	99	h	si d8 = 0, 1 ou 2, intervalle de dégivrage 0=le dégivrage à intervalles n'est jamais activé si d8 = 3, intervalle maximum de dégivrage
d2	-99	99	°C/°F (1)	température de l'évaporateur en fin de dégivrage ; voir également d3
d3	0	99	min	si P4 = 0 ou 2, durée du dégivrage si P4 = 1, durée maximale du dégivrage ; voir également d2 0=le dégivrage n'est jamais activé
d4	0	1	-	dégivrage à l'allumage du dispositif (4) 1=OUI
d5	0	99	min	si d4 = 0, temps minimum entre l'allumage du dispositif et l'activation du dégivrage (4) si d4 = 1, retard de l'activation du dégivrage à compter de l'allumage du dispositif (4)
d6	0	2	-	température affichée durant le dégivrage (uniquement si P5 = 0) 0=température ambiante 1=si à l'activation du dégivrage, la température ambiante est inférieure au "point de consigne de fonctionnement + Δt", au maximum "point de consigne de fonctionnement + Δt" ; si au dégivrage, la température ambiante est supérieure au "point de consigne de fonctionnement + Δt", au maximum la température ambiante à l'activation du dégivrage (8) (9) 2=étiquette "dEF"
d7	0	15	min	durée de l'égouttement (durant l'égouttement le compresseur reste éteint)
d8	0	3	-	modalité d'activation du dégivrage 0=A INTERVALLES - PENDANT TEMPS - le dégivrage reste actif si le dispositif est resté allumé au total pendant le temps d0 1=A INTERVALLES - POUR ALLUMAGE DU COMPRESSEUR - le dégivrage reste actif si le compresseur est resté allumé au total pendant le temps d0 2=A INTERVALLES - POUR TEMPÉRATURE DE L'ÉVAPORATEUR - le dégivrage s'active si la température de l'évaporateur est restée inférieure à la température d9 au total pendant le temps d0 (10) 3=ADAPTATIF - le dégivrage s'active à des intervalles dont la durée dépend chaque fois de la durée des allumages du compresseur, de la température de l'évaporateur et de l'activation de l'entrée du micro-interrupteur de la porte ; voir également d18, d19, d20, d22, i13 et i14 (10)
d9	-99	99	°C/°F (1)	température de l'évaporateur au-delà de laquelle le comptage de l'intervalle de dégivrage est suspendu (uniquement si d8 = 2)
d11	0	1	-	activation de l'alarme de dégivrage terminée en raison de la durée maximale (code "dFd") ; uniquement si P4 = 1 et en l'absence d'erreur de la sonde évaporateur (code "Pr2") 1=OUI
d18	0	999	min	intervalle de dégivrage (le dégivrage s'active si le compresseur est resté allumé au total, avec la température de l'évaporateur inférieure à la température d22, pendant le temps d18 ; uniquement si d8 = 3) 0=le dégivrage n'est jamais activé suite à cette condition
d19	0	40	°C/°F (1)	température de l'évaporateur en dessous de laquelle le dégivrage s'active, c'est-à-dire "moyenne des températures de l'évaporateur - d19") (uniquement si d8 = 3)
d20	0	999	min	durée minimale consécutive de l'allumage du compresseur provoquant l'activation du dégivrage 0=le dégivrage n'est jamais activé suite à cette condition
d22	0	19,9	°C/°F (1)	température de l'évaporateur au-dessus de laquelle le comptage de l'intervalle de dégivrage est suspendu (relative à la moyenne des températures de l'évaporateur - c'est-à-dire "moyenne des températures de l'évaporateur +d22") (uniquement si d8 = 3) ; voir également d18

PARAM.	MIN.	MAS.	U.M.	ALARME DE TEMPÉRATURE (11) (12)
A1	0	99	°C/°F (1)	température ambiante en dessous de laquelle l'alarme de température minimale se déclenche (code "AL" ; relative au point de consigne de fonctionnement, c'est-à-dire "point de consigne de fonctionnement - A1") ; voir également A11 0=alarme absente
A4	0	99	°C/°F (1)	température ambiante au-dessus de laquelle l'alarme de température maximale se déclenche (code "AH" ; relative au point de consigne de fonctionnement, c'est-à-dire "point de consigne de fonctionnement + A4") ; voir également A11=alarme absente
A6	0	99	10 min	retard alarme de température maximale (code "AH") à compter de l'allumage du dispositif (4)
A7	0	199	min	retard alarme de température minimale (code "AL") et maximale (code "AH")
A11	0,1	15	°C/°F (1)	différentiel des paramètres A1 et A4

PARAM.	MIN.	MAS.	U.M.	ENTRÉES NUMÉRIQUES
i0	0	4	-	effet provoqué par l'activation de l'entrée numérique 0=aucun effet 1=MICRO-INTERRUPTEUR PORTE - ACTIVATION DE L'ALARME ENTRÉE MICRO-INTERRUPTEUR PORTE (code "id") - le compresseur s'éteint (au maximum pendant le temps i3 ou jusqu'à ce que l'entrée soit désactivée) ; voir également i2 (13) 2=MULTIFONCTION - ACTIVATION DE LA FONCTION "ENERGY SAVING" – la fonction "energy saving" s'active (avec un effet uniquement sur le compresseur, jusqu'à ce que l'entrée soit désactivée) ; voir également r4 3=MULTIFONCTION - ACTIVATION DE L'ALARME ENTRÉE MULTIFONCTION (code "iA") - le dispositif continu à fonctionner régulièrement ; voir également i2 4=MULTIFONCTION - ACTIVATION DE L'ALARME PRESSOSTAT (code "iA") - le compresseur s'éteint (jusqu'à ce que l'entrée soit désactivée) ; voir également i2

i1	0	1	-	type de contact de l'entrée numérique 0=normalement ouvert (entrée active avec contact fermé) 1=normalement fermé (entrée active avec contact ouvert)
i2	-1	120	min	si i0 = 1, retard de la signalisation d'alarme entrée micro-interrupteur porte (code "id") -1=l'alarme n'est pas signalée si i0 = 3, retard de la signalisation de l'alarme entrée multifonction (code "iA") -1=l'alarme n'est pas signalée si i0 = 4, retard de l'allumage du compresseur à compter de la désactivation de l'alarme pressostat (code "iA") -1=réservé
i3	-1	120	min	durée maximale de l'effet provoqué par l'activation de l'entrée micro-interrupteur porte sur le compresseur -1=l'effet dure jusqu'à ce que l'entrée soit désactivée
i10	0	999	min	temps qui doit s'écouler en l'absence d'activations de l'entrée du micro-interrupteur porte (après que la température ambiante a atteint le point de consigne de fonctionnement) afin que la fonction "energy saving" soit activée ; voir également r4 et HE2 0=la fonction n'est jamais activée suite à cette condition
i13	0	240	-	nombre d'activations de l'entrée du micro-interrupteur porte provoquant l'activation du dégivrage 0=le dégivrage n'est jamais activé suite à cette condition
i14	0	240	min	durée minimale de l'activation de l'entrée du micro-interrupteur porte provoquant l'activation du dégivrage 0=le dégivrage pour cette condition n'est jamais activé







PARAM.	MIN.	MAS.	U.M.	ENERGY SAVING
HE2	0	99	min	durée maximale de la fonction "energy saving" activée suite à l'absence d'activations de l'entrée du micro-interrupteur porte ; voir également r4 et i10 0=la fonction dure jusqu'à ce que l'entrée soit activée
HE3	0	240	min	temps qui doit s'écouler en l'absence d'opérations avec les touches afin que la modalité "faible consommation" soit activée 0=la modalité n'est jamais activée

PARAM.	MIN.	MAS.	U.M.	DIVERS
POF	0	1	-	activation de la touche  1 = OUI
PAS	-99	999	-	mot de passe d'accès aux paramètres de configuration 0=le mot de passe ne doit pas être sélectionné

- (1) l'unité de mesure dépend du paramètre P2
(2) saisir opportunément les paramètres relatifs aux régulateurs après la saisie du paramètre P2
(3) si le paramètre r5 est saisi à 1, la fonction "energy saving" et la gestion du dégivrage ne seront pas activées
(4) le paramètre a également de l'effet après une interruption de l'alimentation se manifestant quand le dispositif est allumé
(5) le temps établi avec le paramètre est également compté quand le dispositif est éteint
(6) le différentiel paramètre est de 2,0 °C/4 °F
(7) si à l'allumage du dispositif la température du condensateur est déjà supérieure à la température établie avec le paramètre C7, le paramètre C8 n'a aucun effet
(8) la valeur de ?t dépend du paramètre r12 (r0 si r12 = 0, r0/2 si r12 = 1)
(9) l'afficheur rétablit le fonctionnement normal quand, au terme de l'égouttement, la température ambiante descend en dessous de la température qui a bloqué l'afficheur (ou si une alarme de température se déclenche)
(10) si le paramètre P4 est saisi à 0 ou à 2, le dispositif fonctionne comme si le paramètre d8 était saisi à 0
(11) durant le dégivrage et l'égouttement, les alarmes des températures sont absentes, à condition que celles-ci se soient manifestées après l'activation du dégivrage
(12) durant l'activation de l'entrée du micro-interrupteur porte, l'alarme de température maximale est absente, à condition que celle-ci se soit manifestée après l'activation de l'entrée
(13) le compresseur s'éteint 10 secondes après l'activation de l'entrée.

TEMPERATURE NORMALE "-2/+10°C" "-2/+8°C" - BASSE TEMPERATURE "-24/-12°C"

Sélection du point de consigne de fonctionnement

- S'assurer que le clavier n'est pas bloqué et qu'aucune procédure n'est en cours
- Toucher la touche  **SET** a DEL  se met à clignoter
- Toucher la touche  ou la touche **FNC**  dans un délai de 15 s ; voir également les paramètres r1 et r2
- Toucher la touche  **SET** ou ne pas opérer pendant 15s : la DEL  s'éteint, après quoi le dispositif quitte la procédure.

Pour quitter la procédure prématurément:

- Toucher la touche  (les éventuelles modifications ne seront pas enregistrées)





On peut également sélectionner le point de consigne de fonctionnement à travers le paramètre **SP**.

Points de consigne



PARAM.	MIN.	MAS.	U.M.	POINT DE CONSIGNE DE FONCTIONNEMENT
r1	r2		°C/°F (1)	point de consigne de fonctionnement ; voir également r0 et r12

Programmation des paramètres de configuration

Pour accéder à la procédure:

- S'assurer qu'aucune procédure n'est en cours
- Toucher la touche enfoncée  **SET** pendant 4 s : l'afficheur indique "PA"
- Enfoncer puis relâcher la touche  **SET**
- Toucher la touche  ou la touche **FNC**  dans un délai de 15 s pour sélectionner la valeur établie avec les paramètres "PAS" (pour la sélection nominale, le paramètre est saisi à -19°)
- Toucher la touche  **SET** ou ne pas opérer pendant 15s : l'afficheur indique "SP"

Pour sélectionner un paramètre:

- Toucher la touche  ou la touche **FNC** 

Pour modifier un paramètre:

- Toucher la touche **SET**
- Toucher la touche **▲** ou la touche **▼** dans un délai de 15 s
- Toucher la touche **SET** ou ne pas opérer pendant 15s

Pour quitter la procédure:

- Toucher la touche **SET** enfoncée pendant 4 s ou ne pas opérer pendant 60 s (les éventuelles modifications seront enregistrées)

Paramètres de configuration

PARAM.	MIN.	MAS.	U.M.	POINT DE CONSIGNE DE FONCTIONNEMENT
SP	r1	r2	°C/°F	point de consigne de fonctionnement ; voir également r0 et r12

LABEL	MIN.	MAS.	U.M.	ENTRÉES ANALOGIQUES
CA1	-25	25	°C/°F	offset sonde enceinte si P4 = 3, offset sonde air en sortie
CA2	-25	25	°C/°F	offset sonde évaporateur
CA3	-25	25	°C/°F	offset sonde auxiliaire
P0	0	1	-	type de sonde 0=PTC 1=NTC
P1	0	1	-	activation point décimal °C 0 = non 1 = oui
P2	0	1	-	unité de mesure température 0 = °C 1 = °F
P3	0	2	-	fonction sonde évaporateur 0 = désactivée 1 = dégivrage + ventilateurs 2 = ventilateurs
P4	0	3	-	fonction entrée configurable 0 = entrée numérique 1 = sonde condensateur 2 = sonde température critique 3 = sonde air en sortie si P4 = 3, température réglage = température produit (CPT)
P5	0	4	-	valeur affichée 0 = température réglage 1 = point de consigne 2 = température évaporateur 3 = température auxiliaire 4 = température air en entrée
P7	0	100	%	pois air en entrée pour calcul température produit (CPT) CPT = $\{[(P7 \times (\text{air en entrée})) + ((100 - P7) \times (\text{air en sortie}))] : 100\}$
P8	0	250	0,1 s	tempo rinfresco display

LABEL	MIN.	MAS.	U.M.	RÉGLAGE
r0	0.1	15	°C/°F	différentiel point de consigne
r1	-99	r2	°C/°F	point de consigne minimum
r2	r1	99	°C/°F	point de consigne maximum
r4	0	99	°C/°F	offset point de consigne en économie d'énergie
r5	0	1	-	réglage pour chaud ou pour froid 0 = pour froid 1 = pour chaud
r6	0	99	°C/°F	offset du point de consigne en surrefroidissement/surchauffe
r7	0	240	min	durée surrefroidissement/surchauffe
r8	0	2	-	fonction supplémentaire touche DOWN 0 = désactivée 1 = surrefroidissement/surchauffe 2 = économie d'énergie
r12	0	1	-	position du différentiel r0 0 = asymétrique 1 = symétrique

LABEL	MIN.	MAS.	U.M.	COMPRESSEUR
C0	0	240	min	retard compresseur ON après power-on
C2	0	240	min	temps minimum compresseur OFF
C3	0	240	s	temps minimum compresseur ON
C4	0	240	min	temps compresseur OFF en alarme sonde enceinte
C5	0	240	min	temps compresseur ON en alarme sonde enceinte
C6	0	200	°C/°F	seuil signalisation condensation élevé
C7	0	200	°C/°F	seuil alarme condensation élevée
C8	0	15	min	retard alarme condensation élevée
C10	0	9999	h	heures compresseur pour entretien 0 = désactivé
C11	0	240	s	retard allumage compresseur 2
C12	0	10	-	nombre démarrages pour rotation compresseurs 0 = désactivé

LABEL	MIN.	MAS.	U.M.	DÉGIVRAGE
d00	0	1	-	activer les paramètres de type b 0 = non 1 = oui

d01	r1	r2	°C/°F	seuil de consigne pour la qualification des paramètres de type b se SP > d01
d0	0	99	h	intervalle dégivrage automatique 0 = seulement manuel si d8 = 3, intervalle maximum
d0b	0	99	h	intervalle dégivrage automatique 0 = seulement manuel si d8 = 3, intervalle maximum
d1	0	2	-	type de dégivrage 0 = électrique 1 = à gaz chaud 2 = pour arrêt compresseur
d1b	0	2	-	type de dégivrage 0 = électrique 1 = à gaz chaud 2 = pour arrêt compresseur
d2	-99	99	°C/°F	0 seuil fin dégivrage
d2b	-99	99	°C/°F	0 seuil fin dégivrage
d3	0	99	min	durée dégivrage si P3 = 1, durée maximum
d3b	0	99	min	durée dégivrage si P3 = 1, durée maximum
d4	0	1	-	activation dégivrage au power-on 0 = non 1 = oui
d5	0	99	min	retard dégivrage après power-on
d6	0	2	-	valeur affichée durant dégivrage 0 = température réglage 1 = afficheur verrouillé 2 = label dEF
d7	0	15	min	temps égouttement
d7b	0	15	min	temps égouttement
d8	0	3	-	mode comptage intervalle dégivrage 0 = heures dispositif ON 1 = heures compresseur ON 2 = heures température évaporateur < d9 3 = adaptatif 4 = en temps réel
d9	-99	99	°C/°F	seuil évaporation pour comptage intervalle dégivrage automatique
d11	0	1	-	activation alarme time-out dégivrage 0 = non 1 = oui
d15	0	99	min	temps consécutif compresseur ON pour dégivrage à gaz chaud
d16	0	99	min	temps pré-égouttement pour dégivrage à gaz chaud
d18	0	999	min	intervalle dégivrage adaptatif si compresseur ON + température évaporateur < d22 0 = seulement manuel
d19	0	40	°C/°F	seuil pour dégivrage adaptatif (relatif à température optimale évaporation) température optimale évaporation - d19
d20	0	999	min	temps consécutif compresseur ON pour dégivrage 0 = désactivé
d21	0	500	min	temps consécutif compresseur ON pour dégivrage après poweron et après surrefroidissement si (température réglage - point de consigne) > 10°C/20 °F 0 = désactivé
d22	0	10	°C/°F	seuil évaporation pour comptage intervalle dégivrage adaptatif (relatif à température optimale évaporation) température optimale évaporation + d22

LABEL	MIN.	MAS.	U.M.	ALARMES
AA	0	2	-	sélection valeur pour alarmes haute/basse température 0 = température réglage 1 = température évaporateur 2 = température auxiliaire
A1	0	99	°C/°F	seuil alarme basse température
A2	0	2	-	type d'alarme basse température 0 = désactivé 1 = relative au point de consigne 2 = absolue
A4	0	99	°C/°F	seuil alarme haute température
A5	0	2	-	type d'alarme haute température 0 = désactivé 1 = relative au point de consigne 2 = absolue
A6	0	99	10 min	retard alarme haute température après power-on
A7	0	240	min	retard alarmes haute/basse température
A8	0	240	min	retard alarme haute température après dégivrage
A9	0	240	min	retard alarme haute température après fermeture porte
A10	0	240	min	durée panne courant pour mémorisation alarme
A11	0,1	15	°C/°F	différentiel rétablissement alarmes haute/basse température

LABEL	MIN.	MAS.	U.M.	VENTILATEURS
F0	0	4	-	mode ventilateurs évaporateur durant fonctionnement normal 0 = OFF 1 = ON 2 = fonction de F15 et F16 si compresseur OFF, ON si compresseur ON 3 = thermostatés (avec F1 et F1A) 4 = thermostatés (avec F1 et F1A) si compresseur ON
F0b	0	4	-	mode ventilateurs évaporateur durant fonctionnement normal

				0 = OFF 1 = ON 2 = fonction de F15 et F16 si compresseur OFF, ON si compresseur ON 3 = thermostatés (avec F1 et F1A) 4 = thermostatés (avec F1 et F1A) si compresseur ON
F1	-99	99	°C/°F	seuil d'évaporateur ventilateur hors
F1A	-99	99	°C/°F	seuil ventilateur évaporateur on si F1A > F1, différentiel F1 = 2 °C/4 °F
F2	0	2	-	mode ventilateurs évaporateur durant dégivrage et égouttement 0 = OFF 1 = ON 2 = fonction de F0
F2b	0	2	-	mode ventilateurs évaporateur durant dégivrage et égouttement 0 = OFF 1 = ON 2 = fonction de F0
F3	0	15	min	temps maximum arrêt ventilateurs évaporateur
F3b	0	15	min	temps maximum arrêt ventilateurs évaporateur
F4	0	240	10 s	temps ventilateurs évaporateur OFF en économie d'énergie
F5	0	240	10 s	temps ventilateurs évaporateur ON en économie d'énergie
F7	-99	99	°C/°F	seuil ventilateurs évaporateur ON après égouttement (relatif au point de consigne)
F9	0	240	s	retard ventilateurs évaporateur OFF après compresseur OFF
F10	0	99	°C/°F	différence « temperature cella - temperature evaporatore » par évaporateur ventole sur
F11	0	99	°C/°F	seuil ventilateurs condensateur ON
F12	0	240	s	retard ventilateurs condensateur OFF après compresseur OFF
F13	0	15	°C/°F	différentiel F11
F15	0	240	s	temps ventilateurs évaporateur OFF avec compresseur OFF si F0 = 2
F16	0	240	s	temps ventilateurs évaporateur ON avec compresseur OFF si F0 = 2

LABEL	MIN.	MAS.	U.M.	ENTRÉES NUMÉRIQUES
i0	0	5	-	fonction entrée microinterrupteur porte 0 = désactivée 1 = compresseur + ventilateurs évaporateur OFF 2 = ventilateurs évaporateur OFF 3 = éclairage enceinte ON 4 = compresseur + ventilateurs évaporateur OFF, éclairage enceinte ON 5 = ventilateurs évaporateur OFF, éclairage enceinte ON
i1	0	1	-	activation entrée microinterrupteur port 0 = avec contact fermé 1 = avec contact ouvert
i2	-1	120	min	retard alarme porte ouverte -1 = désactivé
i3	-1	120	min	temps maximum inhibition réglage avec porte ouverte -1 = jusqu'à la fermeture
i5	0	7	-	Fonction entrée microinterrupteur porte/multifonction 0 = désactivée 1 = économie d'énergie 2 = alarme iA 3 = charge depuis touche ON 4 = allumage/extinction du dispositif 5 = alarme Cth 6 = alarme th 7 = compresseur + ventilateurs évaporateur OFF, éclairage enceinte ON 8 = ventilateurs évaporateur OFF, éclairage enceinte ON
i6	0	1	-	activation entrée microinterrupteur porte/multifonction 0 = avec contact fermé 1 = avec contact ouvert
i7	0	120	min	retard alarme entrée multifonction -1 = désactivé si i5 = 5 ou 6, retard compresseur ON après rétablissement alarme
i10	0	999	min	temps consécutif porte fermée pour économie d'énergie après que température de réglage < SP 0 = désactivé
i13	0	240	-	nombre ouvertures porte pour dégivrage 0 = désactivé
i14	0	240	min	temps consécutif porte ouverte pour dégivrage 0 = désactivé

LABEL	MIN.	MAS.	U.M.	SORTIES NUMÉRIQUES
uc1	0	12	-	configuration du relais K1 0 = compresseur 1 = dégivrage 2 = ventilateurs évaporateur 3 = éclairage enceinte 4 = antibuée 5 = charge depuis touche 6 = alarme 7 = résistances porte 8 = résistances pour zone neutre 9 = ventilateurs condensateur 10 = on/stand-by 11 = compresseur 2 12 = désactivé
uc2	0	12	-	configuration du relais K2 (comme uc1)

uc3	0	12	-	configuration du relais (comme uc2)
uc4	0	12	-	configuration du relais K4 (comme uc3)
u2	0	1	-	activation éclairage enceinte et charge depuis touche en standby 0 = non 1 = oui en mode manuel
u4	0	1	-	désactivation sortie alarme 0 = non 1 = oui
u5	-99	99	°C/°F	seuil résistances porte ON différentiel = 2 °C/4 °F
u6	0	120	min	durée antibuée ON
u7	-99	99	°C/°F	seuil zone neutre pour chauffage (relatif au point de consigne) point de consigne + u7
u8	1	15	°C/°F	différentiel de u7

LABEL	MIN.	MAS.	U.M.	ÉCONOMIE D'ÉNERGIE (si r5 = 0)
HE2	0	999	min	durée maximum économie d'énergie -1 = jusqu'à l'ouverture de la porte

LABEL	MIN.	MAS.	U.M.	ÉCONOMIE D'ÉNERGIE EN TEMPS RÉEL (si r5 = 0)
H01	0	23	h	horaire économi journalier
H02	0	24		durée maximum économi

LABEL	MIN.	MAS.	U.M.	DÉGIVRAGE EN TEMPS RÉEL (si d8 = 4)
Hd1	-	-	-	horaire 1er dégivrage journalier h- = désactivé
Hd2	-	-	-	horaire 2er dégivrage journalier h- = désactivé
Hd3	-	-	-	horaire 3er dégivrage journalier h- = désactivé
Hd4	-	-	-	horaire 4er dégivrage journalier h- = désactivé
Hd5	-	-	-	horaire 5er dégivrage journalier h- = désactivé
Hd6	-	-	-	horaire 6er dégivrage journalier h- = désactivé

LABEL	MIN.	MAS.	U.M.	SÉCURITÉS
Pbu	0	2	-	sélection d'événement pour activation buzzer 0 = désactivé 1 = alarmes 2 = boutons et alarmes
POF	0	1	-	activation touche ON/STAND-BY 0 = non 1 = ou
PAS	-99	999	-	mot de passe
PA1	-99	999	-	mot de passe 1er niveau
PA2	-99	999	-	mot de passe 2e niveau





LABEL	MIN.	MAS.	U.M.	HORLOGE
POF	0	1	-	activation horloge 0 = non 1 = oui

LABEL	MIN.	MAS.	U.M.	ENREGISTREMENT DE DONNÉES EVLINK
bLE	0	99	-	configuration du port série pour la connectivité 0 = libre 1 = forcé pour EVconnect ou EPoCA 2-99 = adresse du réseau local EPoCA
rE0	0	240	min	intervalle échantillonnage enregistreur de données
rE1	0	5	-	sélection température pour enregistreur de données 0 = aucune 1 = enceinte 2 = évaporateur 3 = auxiliaire 4 = enceinte et évaporateur 5 = toutes

LABEL	MIN.	MAS.	U.M.	MODBUS
LA	1	247	-	adresse MODBUS
Lb	0	3	-	débit en bauds MODBUS 0 = 2 400 bauds 1 = 4 800 bauds 2 = 9 600 bauds 3 = 19 200 bauds parité even

GESTION HUMIDITÉ (seulement sur appareils Pastry & Bakery)





Il est possible de décider la valeur de l'humidité que l'on désire selon le type d'aliment que l'on veut garder :

- S'assurer que le clavier n'est pas bloqué et qu'aucune procédure n'est en cours
- Toucher la touche **FNC**  pour 2 s : l'écran affichera le label de configuration dell'umidità
(**rH⁺** = humidité élevée ou **rH⁻** = faible humidité)
- Toucher la touche **SET**  pour 2 s pour modifier le paramètre
- Toucher la touche   pour confirmer et sortir de la procédure.

ALARMS

TEMPERATURE NORMALE "0/+10°C" "+2/+10°C"

Signalisations

DEL	SIGNIFICATION
	DEL compresseur si elle est allumée, cela signifie que le compresseur est sous tension si elle clignote: - la sélection du point de consigne de fonctionnement est en cours - une protection du compresseur est en cours
	DEL dégivrage si elle est allumée, cela signifie que le dégivrage est en cours si elle clignote, cela signifie que l'égouttement est en cours
	DEL energy saving si elle est allumée et si l'afficheur est sous tension, cela signifie que la fonction "energy saving" est en cours si elle est allumée et si l'afficheur est hors tension, cela signifie que la modalité "faible consommation" est en cours ; enfoncer une touche pour rétablir l'affichage normal
°C	DEL degré Celsius si elle est allumée, l'unité de mesure des températures est le degré Celsius
°F	DEL degré Fahrenheit si elle est allumée, l'unité de mesure des températures est le degré Fahrenheit
	DEL on/stand-by si elle est allumée, cela signifie que le dispositif est éteint (état "stand-by")

Indications

CODE	SIGNIFICATION
Loc	le clavier est bloqué
- - -	le fonctionnement demandé n'est pas disponible
dEF	le dégivrage est en cours

Alarmes

CODE	SIGNIFICATION
AL	Alarme de température minimale Solutions : - vérifier la température ambiante; voir le paramètre A1 Principales conséquences: - le dispositif continuera à fonctionner régulièrement
AH	Alarme de température maximale Solutions : - vérifier la température ambiante; voir le paramètre A4 Principales conséquences: - le dispositif continuera à fonctionner régulièrement
id	Alarme entrée micro-interrupteur porte Solutions : - vérifier les causes de l'activation de l'entrée; voir les paramètres i0 et i1 Principales conséquences: - l'effet établi avec le paramètre i0 - la sortie d'alarme est activée
dFd	Alarme dégivrage terminé en raison de la durée maximale Solutions:

	<ul style="list-style-type: none"> - vérifier l'intégrité de la sonde de l'évaporateur; voir les paramètres d2, d3 et d11 - enfoncer une touche pour rétablir l'affichage normal Principales conséquences: <ul style="list-style-type: none"> - le dispositif continuera à fonctionner régulièrement
--	---

Quand la cause de l'alarme disparaît, le dispositif rétablit le fonctionnement normal, sauf pour les alarmes suivantes:

- l'alarme du compresseur bloqué (code "CSd") qui exige l'extinction du dispositif ou l'interruption de l'alimentation
- l'alarme dégivrage terminé en raison de la durée maximale (code "dFd") exigeant qu'on appuie sur la touche.







Erreurs

CODE	SIGNIFICATION
Pr1	Erreur sonde ambiante Solutions: <ul style="list-style-type: none"> - vérifier que la sonde est du type PTC ou NTC; voir le paramètre P0 - vérifier le raccordement dispositif-sonde - vérifier la température ambiante Principales conséquences: <ul style="list-style-type: none"> - l'activité du compresseur dépendra des paramètres C4 et C5 - le dégivrage n'est jamais activé
Pr2	Erreur sonde évaporateur ou sonde condensateur Solutions : <ul style="list-style-type: none"> - les mêmes que dans le cas précédent mais se rapportant à la sonde évaporateur ou à la sonde condensateur Principales conséquences : <ul style="list-style-type: none"> - si le paramètre P4 est saisi à 1, le temps de dégivrage sera celui établi avec le paramètre d3 - si le paramètre P4 est saisi à 1 et le paramètre d8 à 2 ou 3, le dispositif fonctionne comme si le paramètre d8 était saisi à 0 - si le paramètre P4 est saisi à 2, l'alarme condensateur surchauffé (code "COH") ne se déclenche jamais - si le paramètre P4 est saisi à 2, l'alarme compresseur bloqué (code "CSd") ne se déclenche jamais

Quand la cause de l'erreur disparaît, le dispositif rétablit le fonctionnement normal.

TEMPERATURE NORMALE "-2/+10°C" "-2/+8°C" - BASSE TEMPERATURE "-24/-12°C"

Signalisations

DEL	SIGNIFICATION
	DEL compresseur si elle est allumée, cela signifie que le compresseur est sous tension si elle clignote: <ul style="list-style-type: none"> - la sélection du point de consigne de fonctionnement est en cours - une protection du compresseur est en cours
	DEL dégivrage si elle est allumée : <ul style="list-style-type: none"> - cela signifie que le compresseur est sous tension - sarà in corso il pregocciamento si elle clignote: <ul style="list-style-type: none"> - le dégivrage est demandé mais une protection du compresseur est en cours - l'égouttement est en cours - le dégivrage est demandé mais un allumage minimum du compresseur est en cours
	DEL ventilateur de l'évaporateur si elle est allumée, cela signifie que le ventilateur de l'évaporateur est sous tension si elle clignote, cela signifie que l'arrêt du ventilateur de l'évaporateur est en cours
HACCP	LED alarme HACCP en mémoire EVlink
AUX	DEL auxiliaire si elle est allumée : <ul style="list-style-type: none"> - les résistances anti-buée sont sous tension
	DEL energy saving si elle est allumée et si l'afficheur sous tension, cela signifie que la fonction "energy saving" est en cours si elle est allumée et si l'afficheur est hors tension, cela signifie que la modalité "faible consommation" est en cours ; enfoncer une touche pour rétablir l'affichage normal
	DEL entretien si elle est allumée, l'entretien du compresseur est nécessaire
°C	DEL degré Celsius si elle est allumée, l'unité de mesure des températures est le degré Celsius
°F	DEL degré Fahrenheit si elle est allumée, l'unité de mesure des températures est le degré Fahrenheit
	DEL on/stand-by si elle est allumée, cela signifie que le dispositif est éteint (état "stand-by")

Indications

CODE	SIGNIFICATION
Loc	le clavier est bloqué
- - -	le fonctionnement demandé n'est pas disponible

Alarmes

CODE	SIGNIFICATION
rtc	Alarme horloge Solutions: configurer la date, l'heure et le jour de la semaine
AL	Alarme de température minimale Solutions : - vérifier la température ambiante ou la température CPT; voir le paramètre A1 Principales conséquences : - l'a sortie d'alarme est activée
AH	Alarme de température maximale Solutions : - vérifier la température ambiante ou la température CPT; voir le paramètre A4 Principales conséquences: - la sortie d'alarme est activée
id	Alarme entrée micro-interrupteur porte Solutions : - vérifier les causes de l'activation de l'entrée; voir les paramètres i0 et i1 Principales conséquences: - l'effet établi avec le paramètre i0 - la sortie d'alarme est activée
PF	Alarme panne courant Solutions: - appuyer sur une touche - vérifier le branchement électrique
dFd	Alarme dégivrage terminé en raison de la durée maximale Solutions: - vérifier l'intégrité de la sonde de l'évaporateur; voir les paramètres d2, d3 et d11 - enfoncer une touche pour rétablir l'affichage normal Principales conséquences : - le dispositif continuera à fonct. régulièrement

Quand la cause de l'alarme disparaît, le dispositif rétablit le fonctionnement normal, sauf pour les alarmes suivantes:
 - l'alarme compresseur bloqué (code "CSd") et l'alarme protection thermique globale (code "th") exigeant la mise hors tension du dispositif ou la coupure de l'alimentation
 - l'alarme de dégivrage terminé en raison de la durée maximale (code "dFd") exigeant la pression d'une touche.

Erreurs

CODE	SIGNIFICATION
Pr1	Erreur sonde compartiment Solutions: - vérifier que la sonde est du type PTC ou NTC; voir le paramètre P0 - vérifier le raccordement dispositif-sonde - vérifier la température ambiante/la température CPT Principales conséquences : - l'activité du compresseur dépendra des paramètres C4 et C5 - si le paramètre P4 est saisi à 3, la température associée au réglage et aux alarmes de température sera la température de l'air à la sortie - le dégivrage n'est jamais activé - la sortie d'alarme est activée - les résistances de la porte sont hors tension - les résistances pour le fonctionnement en zone neutre sont mises hors tension
Pr2	Erreur sonde évaporateur/defrost Solutions: - les mêmes que dans le cas précédent mais se rapportant à la sonde évaporateur Principales conséquences: - si le paramètre P3 est saisi à 1, le temps de dégivrage sera celui établi avec le paramètre d3 - si le paramètre P3 est saisi à 1 et le paramètre d8 à 2 ou 3, le dispositif fonctionne comme si le paramètre d8 était saisi à 0 - si le paramètre P3 est saisi à 1 ou 2 et le paramètre F0 à 3 ou 4, le dispositif fonctionne comme si le paramètre était saisi à 2 - l'a sortie d'alarme est activée

Quand la cause de l'erreur disparaît, le dispositif rétablit le fonctionnement normal.

DEGIVRAGE

LE DÉGIVRAGE DES ARMOIRES FRIGORIFIQUES ESST TOTALEMENT AUTOMATQUE.

Le dégivrage des appareils "TEMPERATURE NORMALE 0/+10°C ÷ +2/10°C " est à air et a lieu toutes les 6 heures automatiquement. Le dégivrage a une durée de 20 mintes.

Le dégivrage des appareils "TEMPERATURE NORMALE -2/+10°C ÷ -2/+8°C " est á résistance et se vérifie automatiquement toutes les 6 heures. La durée du cycle de dégivrage est automatiquement réglé par l'appareil.

Le dégivrage des appareils "BASSE TEMPERATURE -24/-12°C" est á gaz chaud et se vérifie automatiquement toutes les 6 heures de fonctionnement du compresseur. La durée du cycle de dégivrage est automatiquement réglé par l'appareil.

Il est possible d'activer touteois en tout moment un cycle de dégivrage en pressant pour 5 secondes la touche "▲❄";le dègivrage automatique suivant aura lieu après 6 heure à partir de ce moment pour appareils "TEMPERATURE NORMALE" et après 6 heures de fonctionnement du compresseur pour appareils "BASSE TEMPERATURE".

CHARGEMENT DU PRODUIT

- Distribuer le produit uniformément à l'intérieur du compartiment réfrigérateur pour consentir une bonne circulation de l'air;
- Eviter de masquer les zones de ventilation de l'installation de refroidissement placée sur la partie gauche du compartiment;
- Eviter de ranger les aliments nécessitant une température de conservation basse dans le dernier tiroir en bas à droite;
- Couvrir ou emballer les aliments avec des films de protections pour aliments avant leur introduction à l'intérieur de l'appareil;
- Ne pas introduire des aliments ou boissons trop chaudes;
- Limiter le nombre d'ouvertures de portes lorsque vous rangez vous retirer les aliments du compartiment;
- Chargement du support de clayette supérieur ne doit pas dépasser la limite de charge;
- Pas de marchandises au-dessous du dernier support de clayette.
- *Modèles Snack*: lors du chargement des tiroirs inférieurs, ne dépassez pas la limite de charge.

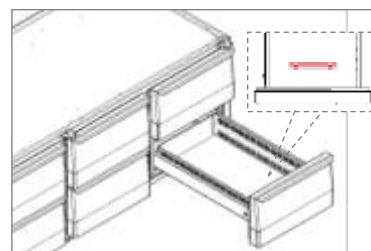
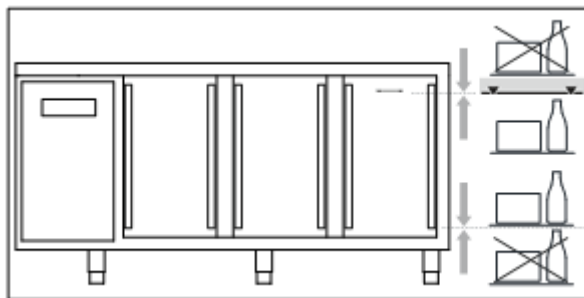

ARRET

En n'importe quelle condition pour arrêter l'appareil il est suffisant de pousser l'interrupteur général 1 en position OFF; la lumière du bouton s'eteindra.

ATTENTION: le bouton interrupteur général 1 n'isole pas l'appareil du courant électrique.

Tournez l'interrupteur du réseau en position OFF.

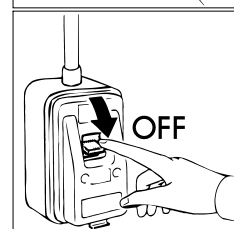
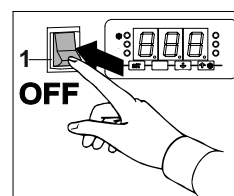

Pour isoler l'appareil enlevez la fiche de la prise.

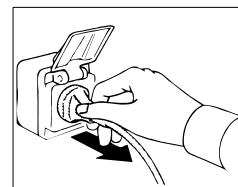

IRREGULARITES DE FONCTIONNEMENT

En cas de fonctionnement irrégulier, avant d'appeler le service après-vente des environs, vérifiez que:

- l'interrupteur général 1 du réseau en position I et le courant est présent;
- la valeur de la température établie est celle désirée;
- les portes sont parfaitement fermées;
- l'appareil n'est pas placé au voisinage de sources de chaleur;
- le condensateur est propre et le ventilateur fonctionne régulièrement;
- une quantité excessive de givre ne couvre pas la plaque évaporante.

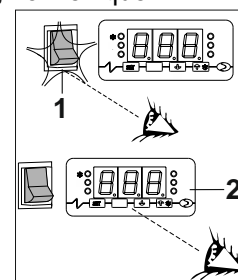

Si ces contrôles sont négatifs, adressez-vous à votre revendeur/service d'assistance en indiquant le modèle et le numéro d'immatriculation estampillés sur la plaquette signalétique.

INTERRUPTIONS D'USAGE

En cas de longues périodes d'inactivité de l'appareil et pour la maintenir dans les meilleures conditions, agissez de la manière suivante:

- prtez l'interrupteur du courant en position OFF.
- enlevez la fiche de la prise.
- videz le réfrigérateur et nettoyez-le comme décrit au chapitre "NETTOYAGE".
- laissez les portes des chambres entrouvertes pour éviter la formation de mauvaises odeurs.

PROBLEMES DE FONCTIONNEMENT

Considéré que bien souvent les problèmes de fonctionnement qui se vérifient sont causés banalement, ils peuvent être solutionnés la plupart du temps sans l'intervention d'un technicien spécialisé. Par conséquent, avant de contacter le service d'assistance technique, faire les contrôles suivants:

PROBLEME	CAUSES POSSIBLES
L'appareil ne s'allume pas	Contrôler que la fiche soit introduite correctement dans la prise de courant
	Contrôler qu'il n'y ait pas de coupure de courant
La température intérieure est trop élevée	Vérifier le réglage du thermostat
	Vérifier que l'appareil ne subisse pas l'influence d'une source de chaleur
	Vérifier que la porte se ferme correctement
L'appareil est trop bruyant	Vérifier la mise à niveau de l'appareil. Une position non horizontale peut être à l'origine de vibrations
	Vérifier que le contact de l'appareil avec quelque objet ou autre appareil ne provoque pas de vibrations
A l'intérieure du frigo il y a des odeurs désagréables	Il ya des odeurs particulièrement fortes (par exmple le fromage et le melon), dans des emballages non fermés hermétiquement
	Les surfaces intérieures doivent être propres
Sur l'appareil se forme de la vapeur d'eau condensée	L'humidité est très élevée
	Les portes ne se sont pas bien fermées

Si en dépit de ces contrôles le problème persiste, s'adresser au service d'assistance technique et signaler:

- la nature du problème
- Le modèle et le numéro d'immatriculation de l'appareil qui peuvent être relevés sur la plaque des caractéristiques électriques, posée sous le tableau de bord de l'appareil.

FICHE TECHNIQUE DU REFRIGERANT

R290

GWP = 3

ODP = 0

❖ Identification des dangers

Gaz liquéfié – Extrêmement inflammable

❖ Mesures d'urgence

• *Inhalation:*

En haute concentration peut causer une asphyxie. Les symptômes peuvent inclure une perte de mobilité et/ou de connaissance. Les victimes peuvent ne pas se rendre compte de l'asphyxie. Peut avoir un effet narcotique en basse concentration. Les symptômes peuvent inclure des vertiges, des maux de tête, des nausées et des pertes de coordination. Déplacer la victime en zone non contaminée en portant l'appareil respiratoire autonome. Maintenir le patient étendu et au chaud. Appeler un médecin. Procéder à la respiration artificielle en cas d'arrêt de la respiration..

• *Contact avec la peau et avec les yeux:*

En cas de fuite, laver avec de l'eau pendant au moins 15 minutes

• *Ingestion:*

Voie d'exposition peu probable

❖ Informations écologiques

On ne connaît pas de dommages sur l'environnement provoqués par ce produit

PLAQUETTE SCHÉMA ÉLECTRIQUE

Le schéma électrique est indiqué sur la dernière page du livret des instructions.

Pos	DESCRIPTION	Pos	DESCRIPTION
1	COMPRESSEUR	20C	RESISTANCE ANTICONDENSATION PORTE
2	VENTILATEUR CONDENSATEUR	21	RESISTANCE DE DEGIVRAGE
3	BORNIER	22	RESISTANCE FOND BASSINES
6	INTERRUPTEUR GENERAL	44	RELAIS COMPRESSEUR
8	FICHE ELECTRIQUE	69	BORNE DE TERRE
9	VENTILATEUR EVAPORATEUR	75	ELECTROSOUPAPE
12	ELECTROSOUPAPE	88	THERMOREGULATEUR
20	RESISTANCE ANTICONDENSATION PORTE	90	THERMOREGULATEUR
20A	RESISTANCE ANTICONDENSATION PORTE	102	THERMOSTAT DE SECURITE
20B	RESISTANCE ANTICONDENSATION PORTE		

INDICE

INFORMACIÓN DE SEGURIDAD.....	2
NORMAS DE SEGURIDAD	2
DESCRIPTION DE LA MAQUINA.....	4
ETIQUETA DE IDENTIFICATION	4
MEDIDAS DE INGOMBRO	5
COLOCACION EN SU LUGAR E INSTALACION	7
LIMPIEZA Y MANUTENCION GENERAL.....	8
MANTENIMIENTO APARATOS DE ACERO	8
MANTENIMIENTO APARATOS DE VX-PET	10
DESPACHO DE RESIDUOS Y DEMOLICION	10
NOTAS GENERALES PARA LA ENTREGA	11
ACCESSORIOS.....	11
DISPOSICIONES HACCP.....	11
CARACTERISTICAS TECNICAS	12
TABLEROS DE MANDO.....	13
ARRANQUE Y FUNCIONAMIENTO	13
BLOQUEO/DESBLOQUEO DEL TECLADO	13
PUNTO DE AJUSTE DE TRABAJO Y PARAMETROS DE CONFIGURACION	14
GESTIÓN HUMEDAD (<i>sólo en equipos Pastry & Bakery</i>).....	21
ALARMAS E SEÑALIZACIONES	21
DESCONGELATION.....	24
CARGA DEL PRODUCTO	24
PARADA	24
ANORMALIDADES DE FUNCIONAMIENTO.....	25
INTERRUPCIONES EN EL FUNCIONAMIENTO	25
PROBLEMAS DE FUNCIONAMIENTO	25
FICHA TÉCNICA DEL REFRIGERANTE.....	26
PLACA ESQUEMA ELECTRICO.....	26

INFORMACIÓN DE SEGURIDAD

ADVERTENCIA: Este aparato contiene hidrocarburos refrigerantes (R290).

PELIGRO: Riesgo de fuego o explosión. Refrigerante inflamable en uso. No utilice dispositivos mecánicos para descongelar el refrigerador. No perforo la línea de refrigerante.

PELIGRO: Riesgo de fuego o explosión. Refrigerante inflamable en uso. Para ser reparado solamente por personal de servicio entrenado. No perforo la línea de refrigerante.

ATENCIÓN: Riesgo de fuego o explosión. Refrigerante inflamable en uso. Consulte el manual de servicio/guía del usuario antes de intentar prestarle servicio a este producto. Seguir todas las precauciones de seguridad.

ATENCIÓN: Riesgo de fuego o explosión. Desechar correctamente de acuerdo a las regulaciones federales o locales. Refrigerante inflamable en uso.

ATENCIÓN: Riesgo de fuego o explosión debido a perforaciones en la tubería de refrigerante; siga las instrucciones de manejo cuidadosamente. Refrigerante inflamable en uso.

ATENCIÓN: Mantenga libres de obstrucciones todas las áreas de ventilación donde se encuentre el equipo o en la estructura donde se fabrica.

ATENCIÓN: no conserve sustancias explosivas, como bombonas spray con propelente inflamable, dentro del aparato..



Señal de peligro de inflamabilidad por presencia de fluido frigorígeno inflamable (R290)

Las instrucciones se encuentran en el sitio web www.sagispa.it.

NORMAS DE SEGURIDAD

Los aparatos están dotados de cable de alimentación con enchufe.

ATENCIÓN: antes de cualquier operación de mantenimiento o limpieza, es necesario aislar el equipo de la red eléctrica:

– poner el interruptor general en posición OFF.

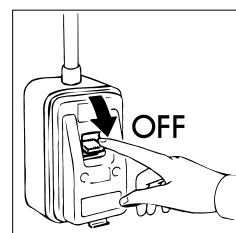

– desenchufar el equipo. La extracción de la clavija debe ser tal que el operador pueda comprobar su desconexión de cada punto de trabajo.

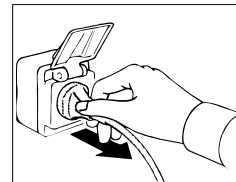

ATENCIÓN: no utilizar tomacorrientes o enchufes desprovistos de puesta a tierra.

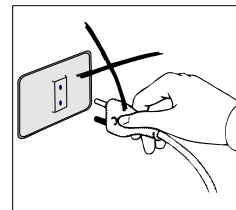

El tomacorrientes de la red eléctrica debe tener su CABLE DE TIERRA.

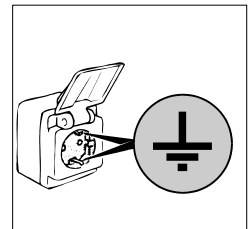

ATENCIÓN: para enchufar en la red, no utilizar adaptadores o prolongadores de cable.

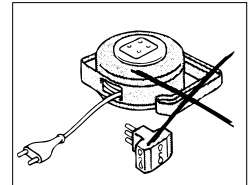

ATENCIÓN: si el cable de alimentación estuviera dañado, deberá ser sustituido por un servicio de asistencia o por personal cualificado para evitar riesgos.

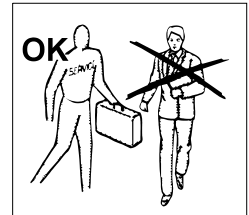

La limpieza y la manutención de la instalación refrigeradora y de la zona compresores requiere la intervención de un técnico especializado y autorizado; por lo tanto no pueden ser efectuadas por personal no preparado.

Para intervenciones de manutención o en caso de anomalías, desenchufar completamente el equipo y solicitar la intervención del SERVICIO DE ASISTENCIA a un centro autorizado y el empleo de repuestos originales. El incumplimiento de las disposiciones anteriores pone en riesgo el estado de seguridad de los equipos.

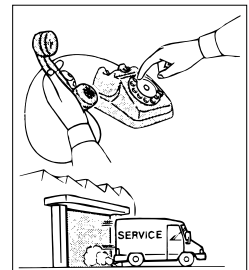

ATENCIÓN: esperar el tiempo necesario para alcanzar la temperatura determinada antes de poner adentro los alimentos a conservar.

Cubrir siempre los alimentos con la película antes de ponerlos en los aparatos.

ATENCIÓN: no introduzca en el equipo bebidas o alimentos calientes.

ATENCIÓN: no realice la limpieza de las partes vecinas del equipo cuando la puerta esté abierta.

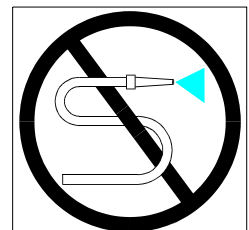

No lave el equipo con chorros de agua directa y a alta presión.

ATENCIÓN: no usar sustancias a base de cloro (lejía, ácido muriático, etc.) o que sean tóxicas para la limpieza o estén cerca de los equipos.

ATENCIÓN: no use dispositivos mecánicos ni otros medios para acelerar el proceso de descongelación que sean diferentes de aquellos recomendados por el fabricante.

ATENCIÓN: no use aparatos eléctricos dentro de los compartimientos que sean diferentes de aquellos recomendados por el fabricante.

El equipo ha sido diseñado para un nivel de presión sonora inferior a 70 db(A)



DESCRIPTION DE LA MAQUINA

Este aparato ha sido proyectado para la refrigeración y conservación de comidas. Cualquier otro uso tiene que considerarse inadecuado.

ATENCIÓN: las máquinas no son idóneas para ser instaladas al aire libre y/o en ambientes sometidos a acciones de agentes atmosféricos.

El fabricante declina toda responsabilidad por usos no previstos.

Las bases poseen en la parte superior una superficie de trabajo disponible también con zócalo posterior; se encuentran además productos sin dicha superficie con análogas capacidades refrigerantes.

Los comandos son con termostato digital e interruptor general.

El grupo motor está colocado a la izquierda de la base en un alojamiento específico.

El evaporador está colocado en el interior del vano motor, uno por cada vano y está protegido con chapas especiales.

La ventilación interna se realiza con ventiladores tangenciales protegidos, colocados sobre el evaporador.

El aparato está equipado con evaporación automática del líquido de condensación.

Las zonas que están en contacto con el producto están realizadas de acero o revestidas de material plástico atóxico.

En caso de parada de la máquina, asegurarse de que exista una buena ventilación, una temperatura comprendida entre -20°C+50°C, una humedad relativa entre el 30% y el 80% y una atmósfera seca no polvorosa.

ETIQUETA DE IDENTIFICACION

La etiqueta de identificación está aplicada de manera estable en el producto y suministra una serie de indicaciones importantes sobre las características técnicas y constructivas del producto.

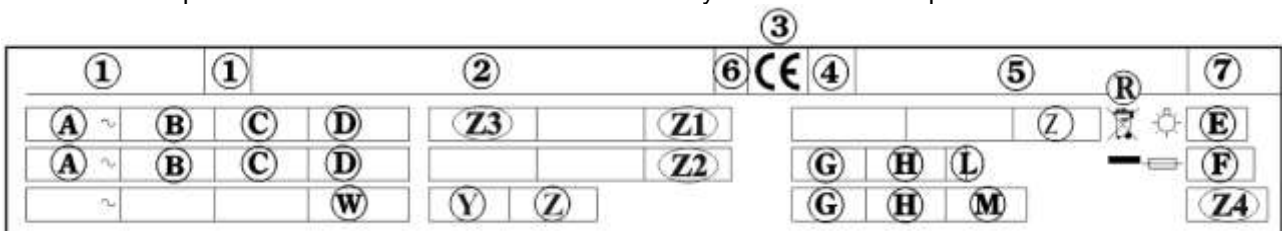

CONTENIDO CAMPOS ETIQUETA TÉCNICA

- | | |
|--|---|
| 1) MODELO | E) POTENCIA TOTAL |
| 2) EMPRESA DE CONSTRUCCION | F) FUSIBLES DE LA CORRIENTE |
| 3) SIGLA MARCA CEE | G) TIPO DE GAS REFRIGERANTE |
| 4) AÑO DE CONSTRUCCION | H) CANTIDAD GAS REFRIGERANTE |
| 5) NUMERO DE MATRICULA | L) TEMPERATURA AMBIENTE |
| 6) CLASE DE AISLAMIENTO ELECTRICO | R) SÍMBOLO RAEE |
| 7) CLASE DE PROTECCION ELECTRICA | W) POTENCIA DE LOS ELEMENTOS DE CALENTAMIENTO |
| A) VOLTAJE DE ALIMENTACION ELECTRICA | Z1) VOLUMEN NETO (RSV) |
| B) INTENSIDAD DE LA CORRIENTE ELECTRICA | Z2) FLUID FOAMING |
| C) FRECUENCIA DE LA ALIMENTACION ELECTRICA | Z3) TEMPERATURA FUNCIONAMIENTO |
| D) POTENCIA NOMINAL | Z4) GWP |

Clase climática *	Temperatura ambiente
3 (SN)	+10°C ---> +32°C
4 (N)	+16°C ---> +32°C
4+ (ST)	+16°C ---> +38°C
4+ (SN-ST)	+10°C ---> +38°C
5 (T)	+16°C ---> +43°C
5 (SN-T)	+10°C ---> +43°C

(*) La clase climática de temperatura indica la temperatura ambiente para la cual puede funcionar el equipo.

MEDIDAS DE INGOMBRO

Consulte las medidas de Vs. aparato.

- Modelos prof.600

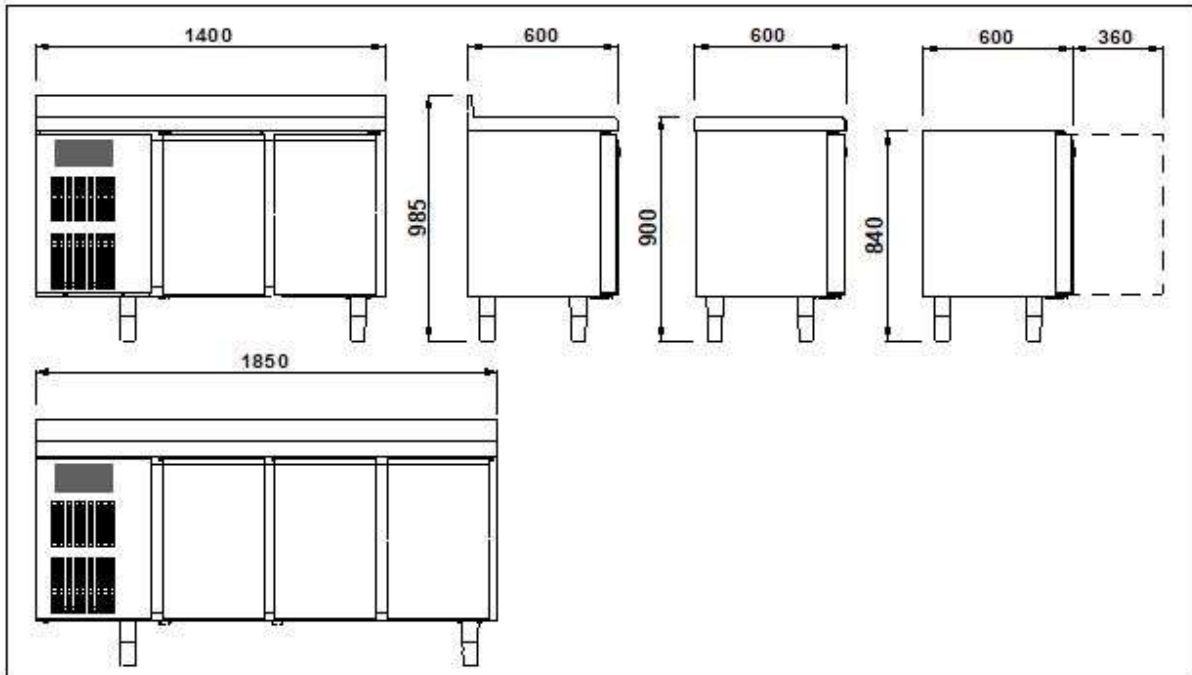

- Modelos prof.700

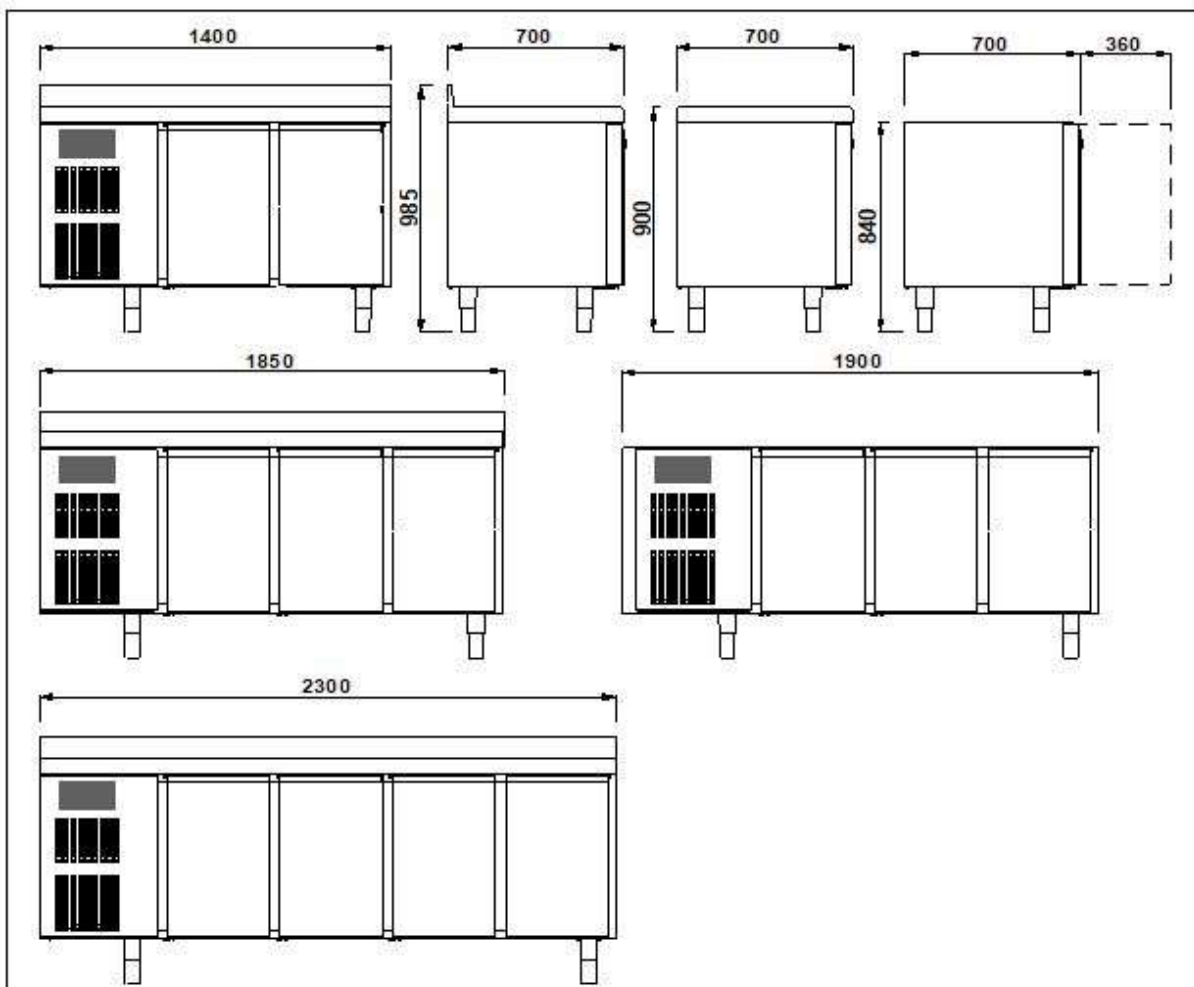

- Modelos snack

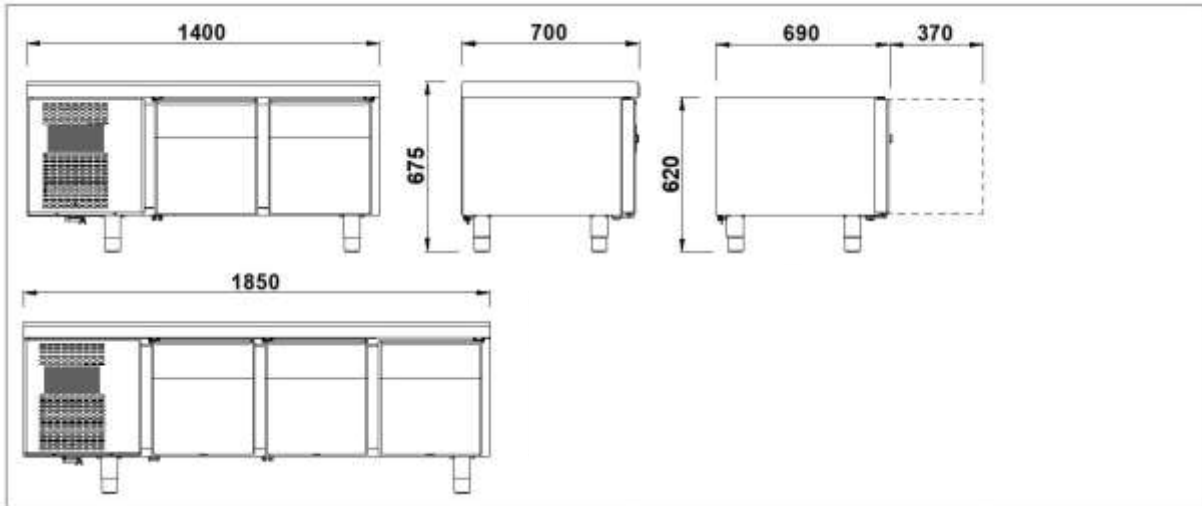

- Modelos pastry & bakery

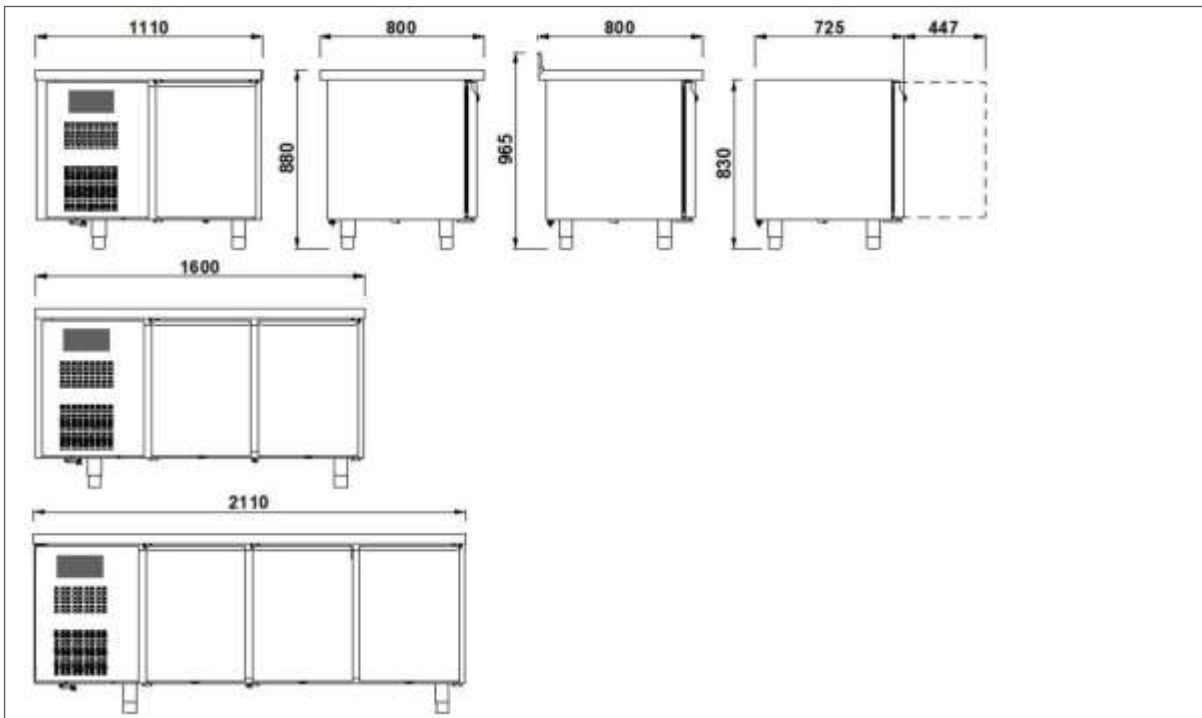

- Modelos pizza

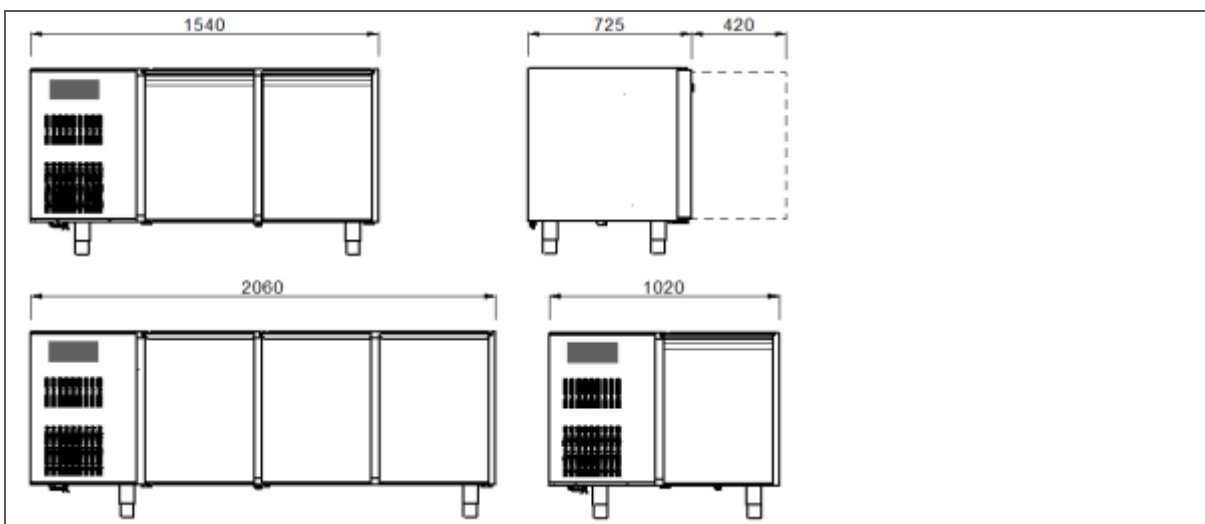

COLOCACION EN SU LUGAR E INSTALACION

Los aparatos se despachan siempre embaladas y sobre palets.

Cuando se reciben y después de haberlas desembrado, en caso de daños o falta de partes, seguir las instrucciones del capítulo "NOTAS GENERALES PARA LA ENTREGA".

Las operaciones de puesta en marcha y de instalación deben ser efectuadas por personas especializadas.



Remover la caja d'embalaje con cuidado para no magullar las superficies del equipaje.

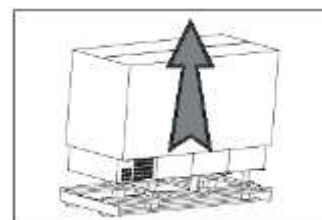

ATENCIÓN: los elementos del embalaje (las bolsas de àstica, il poliéster, los clavos, etc) no deben dejarse al alcance de los ninos porque pueden ser causa de peligros.

Con un carro de horquillas levante el aparato y llévelo al lugar de instalación prestando atención a que la carga esté bien balanceada.

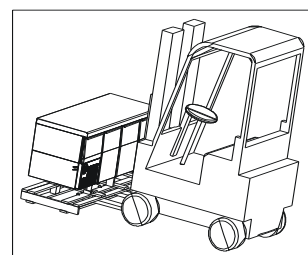

ATENCIÓN: ya sea para la colocación en el lugar de instalación como para los desplazamientos futuros no empuje o arrastre el aparato, para evitar que se vuelque o se causen daños en algunas partes del mismo.

ATENCIÓN: no coloque el aparato cerca de fuentes de calor o en ambientes con temperatura elevada; esto podría causar un menor rendimiento del mismo y una excesiva sollicitación de la instalación de refrigeración.



Coloque el aparato en su ubicación final.

Asegúrese de que haya ventilación adecuada en el cuarto. No asignar el equipo a entornos de temperatura superior a la clase climática declarada.

Quite la película protectora del producto.

Esta operación puede producir descargas fastidiosas aunque no peligrosas (electricidad estática). El inconveniente se elimina o se reduce considerablemente manteniendo una mano siempre en contacto con el aparato o conectando a tierra la envoltura externa.

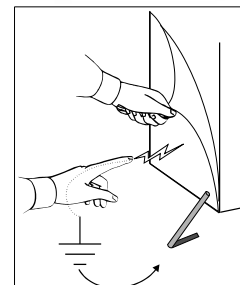

A esta altura se pueden regular las pies del aparato para nivelarlo.

Nivele el aparato manteniéndolo ligeramente inclinado hacia atrás para facilitar el perfecto cerrado de las puertas.

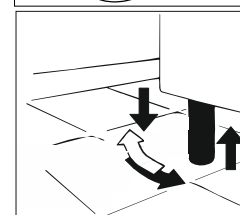

Limpie con agua tibia y jabón neutro (según lo indicado en el capítulo “LIMPIEZA”) y monte los posibles accesorios.

Controle que la tensión de la red corresponda a la indicada en la etiqueta de las características técnicas del aparato.

ATENCIÓN: controle que el tomacorriente de la red esté provisto de puesta a tierra; de lo contrario provéala.

Introduzca luego el enchufe en el tomacorriente específico.

El aparato, además, se debe incluir en un sistema equipotencial cuya eficiencia debe ser verificada de acuerdo a las normas vigentes. La conexión se realiza mediante un tornillo marcado con la sigla “Equipotencial” ubicada en la zona compresores.

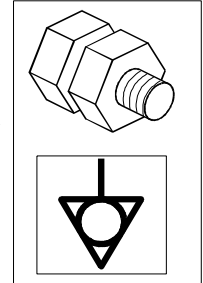

A esta altura las operaciones de puesta en obra se han terminado.

LIMPIEZA Y MANUTENCION GENERAL

Para asegurar el constante rendimiento de la cabina, se aconseja realizar las operaciones de limpieza y manutención generales.

Antes de iniciar con las mismas, hacer cuanto sigue:

- poner el interruptor de línea en la posición OFF
- desenchufar el equipo y esperar a que se haya descongelado completamente.

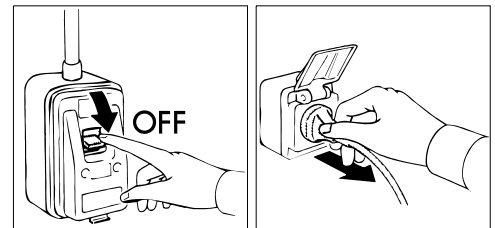

Con un aspirador, un pincel o un cepillo no metálico, limpie con atención el grupo refrigerante y especialmente la batería con aletas.

ATENCIÓN: para la limpieza y manutención del equipo refrigerante y de la zona compresores es necesaria la intervención de un técnico especializado y autorizado; por este motivo no debe ser efectuado por personal no idóneo.

Clean the external and internal surfaces with water and neutral soap or detergent; a little vinegar in the water will remove eventual bad smells.

Rinse abundantly with pure water and dry up accurately.

A este punto han terminado las operaciones de manutención y limpieza generales.

MANTENIMIENTO APARATOS DE ACERO

LIMPIEZA DIARIA

Para garantizar una higiene y una conservación perfectas del aparatos es conveniente efectuar periódicamente y/o diariamente las siguientes operaciones de limpieza indicadas a continuación:

1. Limpiar cuidadosamente las superficies del compartimiento pasando una esponja suave humedecida en agua y detergente neutro, y luego exprimida, únicamente en el sentido del satinado.
2. El detergente no debe contener cloro y no debe ser abrasivo.
 - 2.a Los detergentes aconsejados son los siguientes tipos:
 - Detergente desinfectante de acción combinada;
(con tensioactivos no iónicos, benzalconio cloruro, sustancias quelantes y pH tampón)

- Detergente para laboratorio, neutro, para lavado manual; (con tensioactivos aniónicos y no iónicos)
- Desengrasante para ambientes alimenticios; (con tensioactivos aniónicos y EDTA)

3. Antes del uso diluir eventualmente los detergentes según las instrucciones incluidas en la etiqueta.
4. Dejar actuar los detergentes al menos 5 minutos.
5. Enjuagar cuidadosamente las paredes del frigorífico con una esponja pasada varias veces en agua corriente.
6. 6. Secar con atención utilizando una esponja limpia.

ATENCIÓN: evitar absolutamente el uso de herramientas o elementos que puedan rayar el equipo con la consiguiente formación de herrumbre.

MANCHAS DE ALIMENTOS Y RESIDUOS ENDURECIDOS

En caso de presencia de manchas de comida o residuos en el aparato, lavar con agua y quitarlos antes de que estos puedan endurecerse.

Si los residuos ya están endurecidos proceder como indicado a continuación:

1. Usar una esponja suave humedecida en agua tibia y detergente neutro (se pueden usar esos previstos para la limpieza diaria, a la concentración más alta entre aquellas previstas en la etiqueta).
2. Humedecer el residuo endurecido de modo tal que se mantenga húmedo por al menos 30 minutos repasando más o menos cada 5 minutos la esponja humedecida en agua y detergente sobre la suciedad endurecida.
3. Al final del ablandamiento quitar el residuo con la esponja humedecida en agua y detergente neutro.
4. Si fuera necesario, recurrir a una espátula de madera o a una esponja fina de acero inoxidable, teniendo cuidado de no dañar la superficie del aparato.
5. Al final del procedimiento se aconseja un ciclo de limpieza diaria de todas las superficies internas del aparato.
6. A limpieza terminada enjuagar cuidadosamente con una esponja pasada varias veces en agua corriente.
7. Secar con atención utilizando una esponja limpia.

También las zonas debajo y cercanas a la cabina deben estar limpias y mantenidas en perfecta higiene. Limpiar con agua y jabón o detergente neutro.

Proteger las chapas con cera con siliconas.

CONSEJOS UTILES PARA LA MANUTENCION DEL ACERO INOXIDABLE

Para la limpieza y mantenimiento de las partes de acero inoxidable, respetar cuanto se especifica a continuación, teniendo presente que la primera regla y fundamental es garantizar la no toxicidad y la máxima higiene de los productos tratados.

El acero inoxidable tiene una capa fina antióxidante que impide la formación de herrumbre.

Existen sustancias o detergentes que pueden destruir o dañar esta capa y comenzar así un proceso de corrosión.

Antes de usar cualquier producto detergente, preguntar al proveedor de confianza cuál es el tipo más adecuado de detergente neutro que no provoca corrosiones al acero.

En caso de rayones en las superficies, es necesario pulir con lana de ACERO INOXIDABLE finísima o esponjas abrasivas de material sintético fibroso frotando en el sentido del satinado.

ATENCIÓN: Para limpiar el ACERO INOXIDABLE no deben usarse esponjitas de hierro y ni siquiera dejarlas apoyadas en las superficies pues los depósitos ferrosos pueden pegarse y provocar la formación de herrumbre por contaminación, comprometiendo el estado de higiene.

MANTENIMIENTO APARATOS DE VX-PET

Para garantizar una higiene y una conservación perfectas del compartimento frigorífico es conveniente efectuar periódicamente y/o diariamente las siguientes operaciones de limpieza.

En caso de presencia de manchas de alimentos o residuos sobre la superficie externa, lavar con agua y quitarlos antes de que éstos puedan endurecerse.

Si los residuos ya se han endurecido usar una esponja suave humedecida en aguarrás o alcohol de quemar.

En caso de presencia de manchas de alimentos o residuos sobre la superficie interna, usar vinagre blanco hirviendo o alcohol de quemar utilizando un paño suave para la limpieza.

Limpiar en el sentido del satinado.

Se aconseja un ciclo de limpieza diario de todas las superficies internas del aparato.

Evitar el uso de cremas abrasivas o pajillas de acero, acetona, trielina y amoníaco.

A limpieza terminada enjuagar cuidadosamente con una esponja pasada varias veces en agua corriente.

Secar con atención utilizando una esponja limpia.

También las zonas debajo y cercanas a la cabina deben estar limpias y mantenidas en perfecta higiene. Limpiar con agua y jabón o detergente neutro.

DESPACHO DE RESIDUOS Y DEMOLICION

ALMACENAJE DE LOS DESHECHOS

Al final del ciclo de vida del producto, no eliminar en el medio ambiente el aparato. Las puertas tendrán que desmontarse antes de la eliminación del aparato. Está admitido u almacenaje provvisorio de los desechos especiales, en vista de una eliminación, por medio del tratamiento y/o almacenaje definitivo.

De todos modos se deben cumplir con las leyes vigentes en cuanto a la tutela del ambiente, en el país del utilizador.

PROCEDIMIENTOS RELATIVOS A LAS MACRO-OPERACIONES DE DESARMADO DEL APARATO

Cada País tiene legislaciones diferentes, por tanto, se tienen que cumplir las prescripciones impuestas por las leyes y entidades encargadas de los Países donde se realiza la demolición.

En general, es necesario devolver el frigorífico a los centros especializados para el retiro/demolición.

Desmontar el frigorífico, agrupando los componentes de acuerdo a su naturaleza química, recordando que en el compresor hay aceite lubricador y fluido refrigerante, que se pueden recuperar y volver a usar, y que los componentes del frigorífico son desechos especiales asimilables a los urbanos. Hacer que el aparato sea inutilizable para su eliminación, sacando el cable de alimentación y cualquier dispositivo de cierre espacios, con el fin de evitar que alguien pueda quedar encerrado en el interior.

LAS OPERACIONES DE DESARMADO, DE TODOS MODOS, TIENE QUE SER REALIZADA POR PERSONAL ESPECIALIZADO.

ELIMINACIÓN SEGURA DE LOS RESIDUOS DE APARATOS ELÉCTRICOS Y ELECTRÓNICOS (DIRECTIVA RAE 2002/96/CE)

No abandonar material contaminante en el ambiente. Efectuar su eliminación en conformidad con lo dispuesto por las leyes vigentes en esta materia.

Conforme con la Directiva RAEE 2002/96/CE (sobre residuos de aparatos eléctricos y electrónicos), al efectuar la eliminación de los equipos el usuario deberá entregarlos en instalaciones de recogida específicas y autorizadas, o bien -en el momento de efectuar una nueva compra- deberá entregarlos aún montados al distribuidor.

Todos los aparatos que deben ser eliminados de modo selectivo y en conformidad con lo dispuesto por la

Directiva RAEE 2002/96/CE, aparecen identificados mediante un símbolo específico .

La eliminación abusiva de residuos de aparatos eléctricos y electrónicos será sancionada en conformidad con lo dispuesto por las leyes vigentes en el territorio en que se ha cometido la infracción.

Los residuos de aparatos eléctricos y electrónicos pueden contener sustancias peligrosas con efectos potencialmente nocivos no sólo para el ambiente, sino también para la salud de las personas. Se aconseja efectuar su eliminación de modo correcto.

NOTAS GENERALES PARA LA ENTREGA

Cuando se recibe el bulto, controlar que el embalaje esté intacto y que no haya sufrido daños durante el transporte.

Después de haber desembalado la cabina frigorífica, controlar que estén todas las partes o componentes y que las características y el estado correspondan a las especificaciones de la orden de compra. Si así no fuera, ponerse en contacto inmediatamente con el vendedor.

Les felicitamos por vuestra óptima elección y les auguramos que podáis utilizar del mejor modo nuestros armarios frigoríficos siguiendo las indicaciones y las precauciones necesarias contenidas en este manual.

Pero recordad que está prohibida la reproducción del presente manual y que, debido a una constante búsqueda de innovación y calidad tecnológica, las características aquí presentes podrían cambiar sin preaviso.

ACCESORIOS

Bajo pedido, el equipo puede ser suministrado con los accesorios que a continuación se indican "*vea el catálogo general*".

DISPOSICIONES HACCP

ATENCIÓN: Verduras crudas, huevos y carnes blancas **NO** pueden ser conservados en los mismos ambientes refrigerados. Las carnes blancas se conservan en un ambiente refrigerado especial.

ATENCIÓN: Evitar la conservación de los alimentos que tengan una temperatura comprendida entre 10°C y 60°C. Utilizar idóneos aparatos (refrigeradores) para reducir la temperatura en el corazón del alimento.

ATENCIÓN: En el momento de sacar alimentos del frigorífico hay que controlar la fecha de vencimiento estampada sobre los paquetes, y utilizar los de vencimiento más cercano. Si se nota un alimento vencido, se lo saca del frigorífico y se lo elimina señalando lo sucedido al responsable de la Empresa en la cual trabajáis.

ATENCIÓN: Los alimentos fácilmente perecederos hay que sacarlos del ambiente refrigerado lo más tarde posible al fin de quedar expuestos a la temperatura ambiente el tiempo indispensable.

ATENCIÓN: No recongelar alimentos precedentemente descongelados.

ATENCION: Numerar los equipos y controlar dos veces al día la temperatura relevada registrando los valores en una hoja especial que debe conservarse por 24 meses.

ATENCION: Eventuales interrupciones de corriente a los frigoríficos pueden efectuarse controlando el tiempo detenido con un reloj eléctrico al fin de eliminar los alimentos que pudieran dañarse.

Temperaturas máximas admitidas para la mercadería

Alimento	Temperatura normal di almacenamiento (°C)	Temperatura máxima de transporte (°C)
Leche fresca pasteurizada	0÷+4	9
Nata fresca	0÷+4	9
Yoghurt, ricota y quesos frescos	0÷+2	9
Productos de la pesca bajo hielo	0÷+2	0÷+4
Carnes bovinas y suinas	0÷+3	10
Carnes blancas	0÷+4	8
Conejo	0÷+2	8
Carne de caza pequeña	0÷+2	8
Carne de caza grande	0÷+2	8
Vísceras	0÷+3	8
Alimentos congelados	-23÷-24	-18
Helados empaquetados	-18÷-20	-18
Fruta y verdura	0÷+4	ambiente

CARACTERISTICAS TECNICAS

En las ultimas paginas de libro instrucciones: caracteristicas tecnicas.

TABLEROS DE MANDO

Todos los aparatos están dotados de un interruptor general y de un termostato:

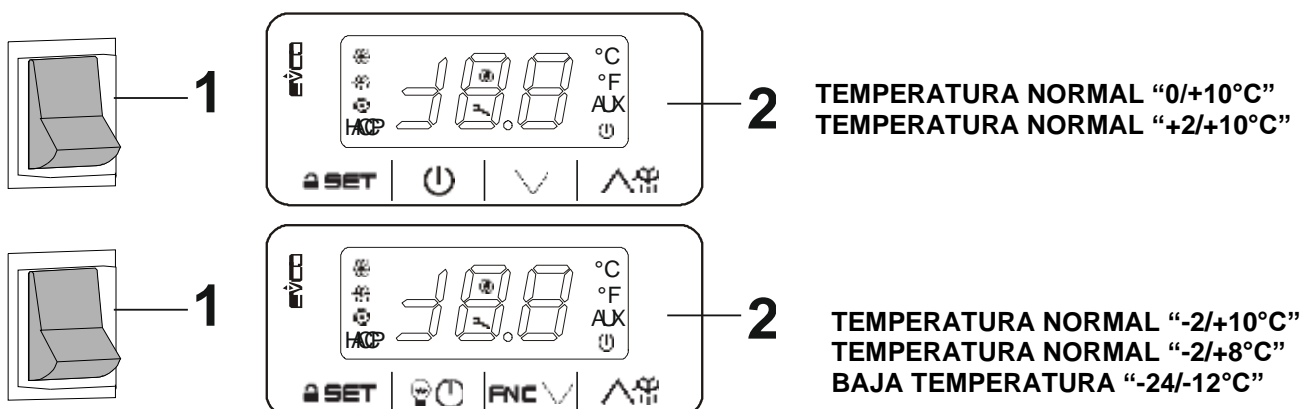

ARRANQUE Y FUNCIONAMIENTO

Para poner en marcha el aparato realice las siguientes operaciones:

- enchufarla en el tomacorriente de red;
- coloque el interruptor de línea en la posición ON;
- presionar el interruptor general (1).

A esta altura es posible colocar la temperatura de funcionamiento a través de una adecuada regulación del termostato (2).

Controle en el display del termostato (2), luego de un tiempo necesario, que la temperatura interna de los aparatos corresponda a la temperatura regulada.

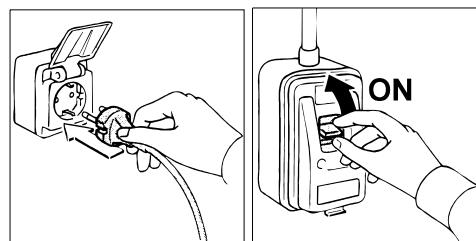

BLOQUEO/DESBLOQUEO DEL TECLADO

Para bloquear el teclado:

- Asegurarse que no haya en curso ningún proceso
- No operar durante 30 s: la pantalla mostrará "Loc" durante 1 s y el teclado se bloqueará automáticamente.

Si el teclado se bloquea, no es posible:

- encender/apagar el dispositivo
- visualizar la temperatura registrada por las sondas
- activar la descongelación de modo manual
- programar el setpoint de trabajo

Estas operaciones generan la visualización de la label "Loc" durante 1 s.

Para desbloquear el teclado:

- Tocar el botón durante 1 s: la pantalla mostrará "UnL" durante 1 s.

PUNTO DE AJUSTE DE TRABAJO Y PARAMETROS DE CONFIGURACION

TEMPERATURA NORMAL "0/+10°C" "+2/+10°C"

Programación del setpoint de trabajo

- Asegurarse que el teclado no esté bloqueado y que no exista ningún problema
- Tocar el botón **SET** : el LED parpadeará
- Tocar el botón o el botón dentro de 15 s; véanse los parámetros r1 y r2
- Tocar el botón **SET** o no accionar durante 15 s: el LED se apagará, luego el dispositivo saldrá del proceso.

Para salir a tiempo del proceso:

- Tocar el botón (si hay modificaciones no serán guardadas)

También es posible programar el setpoint de trabajo mediante el parámetro **SP**.

Puntos de ajuste de trabajo

LABEL	MIN.	MAS.	U.M.	PUNTOS DE AJUSTE DE TRABAJO
r1	r2		°C/°F (1)	setpoint de trabajo; véase también r0 y r12

Programación de los parámetros de configuración

Para entrar en el proceso:

- Asegurarse que no haya en curso ningún proceso
- Tocar el botón **SET** durante 4 s: la pantalla mostrará "PA"
- Tocar el botón **SET**
- Tocar el botón o el botón dentro de 15 s para programar el valor establecido con el parámetro "PAS" (en configuración de fábrica el parámetro se programa en -19°)
- Tocar el botón **SET** o no accionar durante 15 s: la pantalla mostrará "SP".

Para seleccionar un parámetro:

- Tocar el botón o el botón

Para programar un parámetro:

- Tocar el botón **SET**
- Tocar el botón o el botón dentro de 15 s.
- Tocar el botón **SET** o no accionar durante 15 s.

Para salir del proceso:

- Tocar el botón **SET** durante 4 s o no accionar durante 60 s (las modificaciones hechas serán guardadas)

Parámetros de configuración

LABEL	MIN.	MAS.	U.M.	PUNTOS DE AJUSTE DE TRABAJO
SP	r1	r2	°C/°F (1)	setpoint de trabajo; véase también r0 y r12

LABEL	MIN.	MAS.	U.M.	ENTRADAS ANALÓGICAS
CA1	-25	25	°C/°F (1)	offset sonda ambiente
CA2	-25	25	°C/°F (1)	si P4 = 1, offset sonda evaporador si P4 = 2, offset sonda condensador
P0	0	1	-	tipo de sonda 0 = PTC 1 = NTC
P1	0	1	-	punto decimal grado Celsius (durante el funcionamiento normal) 1 = Sí
P2	0	1	-	unidad de medida temperatura (2) 0 = °C (grado Celsius; la resolución depende del parámetro P1) 1 = °F (grado Fahrenheit; la resolución es de 1 °F)
P4	0	2	-	función de la segunda entrada 0 = entrada digital (micro puerta o multifunción) 1 = entrada analógica (sonda evaporador) 2 = entrada analógica (sonda condensador)
P5	0	2	-	magnitud visualizada durante el funcionamiento normal 0 = temperatura ambiente 1 = setpoint de trabajo 2 = si P4 = 0, "- - -" si P4 = 1, temperatura del evaporador si P4 = 2, temperatura del condensador
P8	0	250	0,1s	retraso visualización variación temperaturas registradas por las sondas

LABEL	MIN.	MAS.	U.M.	REGULADOR PRINCIPAL
r0	0.1	15	°C/°F (1)	diferencial del setpoint de trabajo; véase también r12
r1	-99	r2	°C/°F (1)	mínimo setpoint de trabajo
r2	r1	99	°C/°F (1)	máximo setpoint de trabajo
r4	0	99	°C/°F (1)	aumento del setpoint de trabajo durante la función "energy saving"; véase también i0, i10 y HE2
r5	0	1	-	funcionamiento para frío o para calor(3) 0 = para frío 1 = para calor

r12	0	1	-	tipo de diferencial del setpoint de trabajo 0 = asimétrico 1 = simétrico
-----	---	---	---	--

LABEL	MIN.	MAS.	U.M.	PROTECCIONES DEL COMPRESOR
C0	0	240	min	Retraso encendido compresor desde el encendido del dispositivo (4)
C2	0	240	min	Duración mínima del apagado del compresor (5)
C3	0	240	s	Duración mínima del encendido del compresor
C4	0	240	min	Duración del apagado del compresor durante el error sonda ambiental (código "Pr1"); véase también C5
C5	0	240	min	Duración del encendido del compresor durante el error sonda ambiental (código "Pr1"); véase también C4
C6	0	199	°C/°F (1)	Temperatura del condensador por encima del cual se activa la alarma condensador sobrecalentado (código "COH") (6)
C7	0	199	°C/°F (1)	Temperatura del condensador por encima de la cual se activa la alarma compresor bloqueado (código "CSd")
C8	0	15	min	Retraso alarma compresor bloqueado (código "CSd") (7)

LABEL	MIN.	MAS.	U.M.	DESCONGELACIÓN
d0	0	99	h	si d8 = 0, 1 o 2, intervalo de descongelación 0 = La descongelación por intervalos no será nunca activada si d8 = 3, máximo intervalo de descongelación
d2	-99	99	°C/°F (1)	temperatura del evaporador de final de descongelación; véase también d3
d3	0	99	min	si P4 = 0 o 2, duración de la descongelación si P4 = 1, duración máxima de la descongelación; véase también d2 0 = la descongelación no será activada
d4	0	1	-	descongelación en el encendido del dispositivo (4) 1 = Sí
d5	0	99	min	si d4 = 0, tiempo mínimo entre el encendido del dispositivo y la activación de la descongelación (4) si d4 = 1, retraso activación descongelación desde el encendido del dispositivo (4)
d6	0	2	-	temperatura visualizada durante la descongelación (sólo si P5 = 0) 0 = temperatura ambiente 1 = si en la activación de la descongelación la temperatura ambiente está por debajo del "setpoint de trabajo + Δt", al máximo "setpoint de trabajo + Δt"; si en la activación de la descongelación, la temperatura ambiente está por encima del "setpoint de trabajo + Δt", como máximo la temperatura ambiente en la activación de la descongelación (8) (9) 2 = label "dEF"
d7	0	15	min	duración del goteo (durante el goteo el compresor quedará apagado)
d8	0	3	-	modo de activación de la descongelación 0 = POR INTERVALOS – POR TIEMPO - la descongelación será activada cuando el dispositivo permanezca encendido por el tiempo d0 1 = POR INTERVALOS – POR ENCENDIDO DEL COMPRESOR – la descongelación será activada cuando el compresor permanezca encendido por el tiempo d0 2 = POR INTERVALOS – POR TEMPERATURA DEL EVAPORADOR – la descongelación será activada cuando la temperatura del evaporador permanezca por debajo de la temperatura d9 durante el tiempo d0 (10) 3 = ADAPTATIVO - la descongelación será activada a intervalos cuya duración estará en función de la duración de los encendidos del compresor, de la temperatura del evaporador y de la activación de la entrada micro puerta; véase también d18, d19, d20, d22, i13 y i14 (10)
d9	-99	99	°C/°F (1)	temperatura del evaporador por encima de la cual el conteo del intervalo de descongelación se suspende (sólo si d8 = 2)
d11	0	1	-	habilitación de la alarma descongelación concluida por duración máxima (código "dFd"; sólo si P4 = 1 y en ausencia de error sonda evaporador (código "Pr2") 1 = Sí
d16	0	999	min	duración del pregoteo (durante el pregoteo el compresor quedará apagado, la salida de la descongelación será activada y el ventilador del evaporador quedará apagado)
d18	0	999	min	intervalo de descongelación (la descongelación se activará cuando el compresor quede encendido, con la temperatura del evaporador, por debajo de la temperatura d22, por el tiempo d18; sólo si d8 = 3) 0 = la descongelación nunca se activará debido de esta condición
d19	0	40	°C/°F (1)	temperatura del evaporador por debajo de la cual se activa la descongelación (relativa al promedio de las temperaturas del evaporador, es decir "promedio de las temperaturas del evaporador - d19") (sólo si d8 = 3)
d20	0	999	min	duración mínima consecutiva del encendido del compresor que provoque la activación de la descongelación 0 = la descongelación nunca se activará debido de esta condición
d22	0	19,9	°C/°F (1)	temperatura del evaporador por encima de la cual el conteo del intervalo de descongelación se suspende (relativa al promedio de las temperaturas del evaporador, es decir "promedio de las temperaturas del evaporador + d22") (sólo si d8 = 3)

LABEL	MIN.	MAS.	U.M.	ALARMAS DE TEMPERATURA (11) (12)
A1	0	99	°C/°F (1)	temperatura ambiente por debajo de la cual se activa la alarma de temperatura de mínima (código "AL"; relativa al setpoint de trabajo, es decir "setpoint de trabajo - A1"); véase también A11 0 = alarma ausente
A4	0	99	°C/°F (1)	temperatura ambiente por encima de la cual se activa la alarma de temperatura de máxima (código "AH"; relativa al setpoint de trabajo, es decir "setpoint de trabajo + A4"); véase también A11 0 = alarma ausente
A6	0	99	10 min	retraso alarma de temperatura de máxima (código "AH") desde el encendido del dispositivo (4)
A7	0	199	min	retraso alarma de temperatura de mínima (código "AL") y de máxima (código "AH")
A11	0,1	15	°C/°F (1)	diferencial de los parámetros A1 y A4

LABEL	MIN.	MAS.	U.M.	ENTRADAS DIGITALES
i0	0	4	-	efecto provocado por la activación de la entrada digital 0 = ningún efecto 1 = MICRO PUERTA - ACTIVACIÓN DE LA ALARMA ENTRADA MICRO PUERTA (código "id") - el compresor será apagado (con el tiempo máximo i3 o hasta que la entrada se desactive); véase también i2 (13) 2 = MULTIFUNCIÓN - ACTIVACIÓN DE LA FUNCIÓN "ENERGY SAVING" – se activará la función "energy saving" (con efecto sólo sobre el compresor, hasta que la entrada se desactive); véase

				también r4 3 = MULTIFUNCIÓN - ACTIVACIÓN DE LA ALARMA DE ENTRADA MULTIFUNCIÓN (código "iA") - el dispositivo seguirá funcionando regularmente; véase también i2 4 = MULTIFUNCIÓN - ACTIVACIÓN DE LA ALARMA PRESÓSTATO (código "iA") - el compresor será apagado (hasta que la entrada se desactive, véase también i2)
i1	0	1	-	tipo de contador de la entrada digital 0 = normalmente abierto (entrada activa con contacto cerrado) 1 = normalmente cerrado (entrada activa con contacto abierto)
i2	-1	120	min	si i0 = 1, retraso señalización alarma entrada micro puerta (código "id") -1 = la alarma no es señalada si i0 = 3, retraso señalización alarma entrada multifunción (código "iA") -1 = la alarma no es señalada si i0 = 4, retraso encendido compresor desde la desactivación de la alarma presóstato (código "iA") -1 = reservado
i3	-1	120	min	duración máxima del efecto provocado por la activación de la entrada micro puerta en el compresor -1 = el efecto durará hasta que la entrada sea desactivada
i10	0	999	min	tiempo que debe transcurrir en ausencia de activaciones de la entrada micro puerta (después que la temperatura ambiente ha alcanzado el setpoint de trabajo) para que la función "energy saving" sea activada, véase también r4 y HE2 0 = la función nunca se activará por efecto de esta condición
i13	0	240	-	número de activaciones de la entrada micro puerta que provoca la activación de la descongelación 0 = la descongelación nunca se activará debido de esta condición
i14	0	240	min	duración mínima de la activación de la entrada micro puerta que provoca la activación de la descongelación 0 = la descongelación para esta condición nunca será activada







LABEL	MIN.	MAS.	U.M.	ENERGY SAVING
HE2	0	99	min	duración máxima de la función "energy saving" activada por efecto de la ausencia de activaciones de la entrada micro puerta; véase también r4 y i10 0 = la función durará hasta que el ingreso sea activado
HE3	0	240	min	tiempo que debe transcurrir en ausencia de operaciones con los botones hasta que el modo "bajo consumo" se active 0 = el modo no será nunca activado

LABEL	MIN.	MAS.	U.M.	VARIOS
POF	0	1	-	activación del botón  1 = SI
PAS	-99	999	-	contraseña de entrada a los parámetros de configuración 0 = la contraseña no deberá ser configurada

- (1) la unidad de medida depende del parámetro P2
(2) programar debidamente los parámetros relativos a los reguladores después de la configuración del parámetro P2
(3) si el parámetro r5 está configurado en 1, la función "energy saving" y la gestión de la descongelación no serán habilitados
(4) el parámetro tiene efecto incluso después de la alimentación que se manifiesta cuando el dispositivo está encendido
(5) el tiempo establecido con el parámetro se cuenta incluso cuando el dispositivo está apagado
(6) el diferencial del parámetro es de 2,0 °C/4 °F
(7) si en el encendido del dispositivo la temperatura del condensador está por encima de aquella establecida con el parámetro C7, el parámetro C8 no tendrá efecto
(8) el valor Δt depende del parámetro r12 (r0 si r12 = 0, r0/2 si r12 = 1)
(9) la pantalla restablece el funcionamiento normal cuando, concluido el goteo, la temperatura ambiente desciende por debajo de aquella que ha bloqueado la pantalla (o si aparece una alarma de temperatura)
(10) si el parámetro P4 se programa en 0 o 2, el dispositivo funcionará como si el parámetro d8 se hubiese programado en 0
(11) durante la descongelación y el goteo, las alarmas de temperatura están ausentes, siempre que éstas se hayan presentado después de la activación de la descongelación
(12) durante la activación de la entrada micro puerta la alarma de temperatura de máxima está ausente, con la condición que ésta se haya presentado después de la activación de la entrada
(13) el compresor se apaga pasados 10 s de la activación de la entrada.

TEMPERATURA NORMAL "-2/+10°C" "-2/+8°C" - BAJA TEMPERATURA "-24/-12°C"

Programación del setpoint de trabajo

- Asegurarse que el teclado no esté bloqueado y que no exista ningún problema
- Tocar el botón  SET : el LED  parpadeará
- Tocar el botón  o el botón  dentro de 15 s; véanse los parámetros r1 y r2
- Tocar el botón  SET o no accionar durante 15 s: el LED  se apagará, luego el dispositivo saldrá del proceso.

Para salir a tiempo del proceso:

- Tocar el botón  (si hay modificaciones no serán guardadas)





También es posible programar el setpoint de trabajo mediante el parámetro SP.

Puntos de ajuste de trabajo

LABEL	MIN.	MAS.	U.M.	PUNTOS DE AJUSTE DE TRABAJO
	r1	r2	°C/°F (1)	setpoint de trabajo; véase también r0 y r12



Programación de los parámetros de configuración

Para entrar en el proceso:

- Asegurarse que no haya en curso ningún proceso
- Tocar el botón  SET durante 4 s: la pantalla mostrará "PA"
- Tocar el botón  SET
- Tocar el botón  o el botón  dentro de 15 s para programar el valor establecido con el parámetro "PAS" (en configuración de fábrica el parámetro se programa en -19")

- Tocar el botón **SET** o no accionar durante 15 s: la pantalla mostrará "SP".

Para seleccionar un parámetro:

- Tocar el botón  o el botón 

Para programar un parámetro:

- Tocar el botón **SET**
- Tocar el botón  o el botón  dentro de 15 s.
- Tocar el botón **SET** o no accionar durante 15 s.

Para salir del proceso:

- Tocar el botón **SET** durante 4 s o no accionar durante 60 s (las modificaciones hechas serán guardadas)

Parámetros de configuración

LABEL	MIN.	MAS.	U.M.	SETPOINT
SP	r1	r2	°C/°F	setpoint

LABEL	MIN.	MAS.	U.M.	ENTRADAS ANALÓGICAS
CA1	-25	25	°C/°F	offset sonda cámara si P4 = 3, offset sonda aire en salida
CA2	-25	25	°C/°F	offset sonda evaporador
CA3	-25	25	°C/°F	offset sonda auxiliar
P0	0	1	-	tipo de sonda 0=PTC 1=NTC
P1	0	1	-	activar punto decimal °C 0 = no 1 = si
P2	0	1	-	unidad de medida temperatura 0=°C 1=°F
P3	0	2	-	función sonda evaporador 0 = desactivada 1 = desescarche + ventiladores 2 = ventiladores
P4	0	3	-	función entrada configurable 0 = entrada digital 1 = sonda condensador 2 = sonda temperatura crítica 3 = sonda aire en salida si P4 = 3, temperatura regulación = temperatura producto (CPT)
P5	0	4	-	valor en el display 0 = temperatura regulación 1 = setpoint 2 = temperatura evaporador 3 = temperatura auxiliar 4 = temperatura aire en entrada
P7	0	100	%	peso aire en entrada para cálculo temperatura producto (CPT) CPT = (((P7 x (aire en entrada)) + [(100 - P7) x (aire en salida)] : 100)
P8	0	250	0,1 s	tiempo actualización display

LABEL	MIN.	MAS.	U.M.	REGULACIÓN
r0	0.1	15	°C/°F	diferencial setpoint
r1	-99	r2	°C/°F	setpoint mínimo
r2	r1	99	°C/°F	setpoint máximo
r4	0	99	°C/°F	offset setpoint en energy saving
r5	0	1	-	regulación para calor o para frío 0 = para frío 1 = para calor
r6	0	99	°C/°F	offset setpoint en sobreenfriamiento/sobrecalentamiento
r7	0	240	min	duración sobreenfriamiento/sobrecalentamiento
r8	0	2	-	función suplementaria tecla DOWN 0 = desactivado 1 = sobreenfriamiento/ sobrecalentamiento 2 = energy saving
r12	0	1	-	posición diferencial r0 0 = asimétrico 1 = simétrico

LABEL	MIN.	MAS.	U.M.	COMPRESOR
C0	0	240	min	retraso compresor on tras power-on
C2	0	240	min	tiempo mínimo compresor off
C3	0	240	s	tiempo mínimo compresor on
C4	0	240	min	tiempo compresor off en alarma sonda cámara
C5	0	240	min	tiempo compresor on en alarma sonda cámara
C6	0	200	°C/°F	umbral aviso alta condensación
C7	0	200	°C/°F	umbral alarma alta condensación
C8	0	15	min	retraso alarma alta condensación
C10	0	9999	h	horas compresor para mantenimiento 0 = desactivado
C11	0	240	s	retraso encendido compresor 2
C12	0	10	-	número arranques para rotación compresores 0 = desactivado

LABEL	MIN.	MAS.	U.M.	DESESCARCHE
d00	0	1	-	habilitar parámetros tipo b 0 = no 1 = sí
d01	r1	r2	°C/°F	umbral de consigna para habilitar parámetros tipo b si SP > d01
d0	0	99	h	intervalo desescarche automático 0 = sólo manual si d8 = 3, intervalo máximo
d0b	0	99	h	intervalo desescarche automático 0 = sólo manual si d8 = 3, intervalo máximo
d1	0	2	-	tipo de desescarche 0 = eléctrico 1 = a gas caliente 2 = para parada compresor
d1b	0	2	-	tipo de desescarche 0 = eléctrico 1 = a gas caliente 2 = para parada compresor
d2	-99	99	°C/°F	umbral final desescarche
d2b	-99	99	°C/°F	umbral final desescarche
d3	0	99	min	duración desescarche si P3 = 1, duración máxima
d3b	0	99	min	duración desescarche si P3 = 1, duración máxima
d4	0	1	-	activar desescarche con power-on 0 = no 1 = sí
d5	0	99	min	retraso desescarche tras power-on
d6	0	2	-	valor en el display en desescarche 0 = temperatura regulación 1 = display bloqueado 2 = etiqueta dEF
d7	0	15	min	tiempo goteo
d7b	0	15	min	tiempo goteo
d8	0	3	-	modalidad cómputo intervalo desescarche 0 = horas dispositivo on 1 = horas compresor on 2 = horas temperatura evaporador < d9 3 = adaptativo 4 = en tiempo real
d9	-99	99	°C/°F	umbral evaporación para cómputo intervalo desescarche automático
d11	0	1	-	activa alarma timeout desescarche 0 = no 1 = sí
d15	0	99	min	tiempo consecutivo compresor on para desescarche con gas caliente
d16	0	99	min	tiempo pre-goteo para desescarche con gas caliente
d18	0	999	min	intervalo desescarche adaptativo si compresor on + temperatura evaporador < d22 0 = sólo manual
d19	0	40	°C/°F	umbral desescarche adaptativo (relativo a temperatura óptima evaporación) temperatura óptima evaporación - d19
d20	0	999	min	tiempo consecutivo compresor on para desescarche 0 = desactivado
d21	0	500	min	tiempo consecutivo compresor on para desescarche tras power on y tras sobreenfriamiento para desescarche tras power on y tras sobreenfriamiento 0... 500 min si (temperatura regulación - setpoint) > 10°C/20 °F 0 = desactivado
d22	0	10	°C/°F	umbral evaporación para cómputo intervalo desescarche adaptativo (relativo a temperatura óptima evaporación) temperatura óptima evaporación + d22

LABEL	MIN.	MAS.	U.M.	ALARMAS
AA	0	2	-	selección valor para alarmas alta/baja temperatura 0 = temperatura regulación 1 = temperatura evaporador 2 = temperatura auxiliar
A1	0	99	°C/°F	umbral alarma baja temperatura
A2	0	2	-	tipo de alarma baja temperatura 0 = desactivado 1 = relativo a setpoint 2 = absoluto
A4	0	99	°C/°F	umbral alarma alta temperatura
A5	0	2	-	tipo de alarma alta temperatura 0 = desactivado 1 = relativo a setpoint 2 = absoluto
A6	0	99	10 min	retraso alarma alta temperatura tras power-on
A7	0	240	min	retraso alarmas alta/baja temperatura
A8	0	240	min	retraso alarma alta temperatura posdesescarche
A9	0	240	min	retraso alarma alta temperatura tras cierre puerta
A10	0	240	min	duración power failure para memorización alarma
A11	0,1	15	°C/°F	diferencial reinicio alarmas alta/baja temperatura

LABEL	MIN.	MAS.	U.M.	VENTILADORES
F0	0	4	-	modalidad ventiladores evaporador en funcionamiento normal 0 = off 1 = on 2 = función de F15 y F16 si compresor off, on si compresor on

				3 = termorreguladas (con F1) 4 = termorreguladas (con F1) si compresor on
F0b	0	4	-	modalidad ventiladores evaporador en funcionamiento normal 0 = off 1 = on 2 = función de F15 y F16 si compresor off, on si compresor on 3 = termorreguladas (con F1 y F1A) 4 = termorreguladas (con F1 y F1A) si compresor on
F1	-99	99	°C/°F	umbral del ventilador de evaporación fuera
F1A	-99	99	°C/°F	umbral del ventilador evaporador on si F1A > F1, diferencial F1 = 2 °C/4 °F
F2	0	2	-	modalidad ventiladores evaporador en desescarche y goteo 0 = off 1 = on 2 = función de F0
F2b	0	2	-	modalidad ventiladores evaporador en desescarche y goteo 0 = off 1 = on 2 = función de F0
F3	0	15	min	tiempo máximo parada ventiladores evaporador
F3b	0	15	min	tiempo máximo parada ventiladores evaporador
F4	0	240	10 s	tiempo ventiladores evaporador off en energy saving
F5	0	240	10 s	tiempo ventiladores evaporador on en energy saving
F7	-99	99	°C/°F	umbral ventiladores evaporador on tras goteo (relativo a setpoint)
F9	0	240	s	retraso ventiladores evaporador off tras compresor off
F10	0	99	°C/°F	diferencia "temperaturas de celda - temperaturas de evaporación" para ventiladores de evaporación on
F11	0	99	°C/°F	umbral ventiladores condensador on
F12	0	240	s	retraso ventiladores condensador off tras compresor off
F13	0	15	°C/°F	diferencial F11
F15	0	240	s	tiempo ventiladores evaporador off con compresor off si F0 = 2
F16	0	240	s	tiempo ventiladores evaporador on con compresor off si F0 = 2

LABEL	MIN.	MAS.	U.M.	ENTRADAS DIGITALES
i0	0	5	-	función entrada micro puerto 0 = desactivado 1 = compresor + ventiladores evaporador off 2 = ventiladores evaporador off 3 = luz cámara on 4 = compresor + ventiladores evaporador off, luz cámara on 5 = ventiladores evaporador off, luz cámara on
i1	0	1	-	activación entrada micro puerto 0 = con contacto cerrado 1 = con contacto abierto
i2	-1	120	min	retraso alarma puerta abierta -1 = desactivado
i3	-1	120	min	tiempo máximo inhibición regulación con puerta abierta -1 = hasta el cierre
i5	0	7	-	función entrada micro puerto/multifunción 0 = desactivado 1 = energy saving 2 = alarma iA 3 = carga tras tecla on 4 = enciende/apaga dispositivo 5 = alarma Cth 6 = alarma th 7 = compresor + ventiladores evaporador off, luz cámara on 8 = ventiladores evaporador off, luz cámara on
i6	0	1	-	activación entrada micro puerto/multifunción 0 = con contacto cerrado 1 = con contacto abierto
i7	0	120	min	retraso alarma entrada multifunción -1 = desactivado si i5 = 5 o 6, retraso compresor on tras restablecimiento alarma
i10	0	999	min	tiempo consecutivo puerta cerrada para energy saving después de que temperatura regulación < SP 0 = desactivado
i13	0	240	-	número aperturas puerta tras desescarche 0 = desactivado
i14	0	240	min	tiempo consecutivo puerta abierta tras desescarche 0 = desactivado

LABEL	MIN.	MAS.	U.M.	USCITE DIGITALI
uc1	0	12	-	configuración relé K1 0 = compresor 1 = desescarche 2 = ventiladores evaporador 3 = luz cámara 4 = antivaho 5 = carga tras tecla 6 = alarma 7 = resistencias puerta 8 = resistencias por zona neutra 9 = ventiladores condensador 10 = on/stand-by

				11= compresor 2 12= desactivado
uc2	0	12	-	configuración relé K2 (como uc1)
uc3	0	12	-	configuración relé K3 (como uc2)
uc4	0	12	-	configuración relé K4 (como uc3)
u2	0	1	-	activa luz cámara y carga tras tecla en standby 0 = no 1 = sí de forma manual
u4	0	1	-	activa silenciar salida alarma 0 = no 1 = sí
u5	-99	99	°C/°F	umbral resistencias puerta on diferencial = 2 °C/4 °F
u6	0	120	min	duración antivaho on
u7	-99	99	°C/°F	umbral zona neutra para calentamiento (relativo a setpoint) setpoint + u7
u8	1	15	°C/°F	diferencial di u7

LABEL	MIN.	MAS.	U.M.	ENERGY SAVING (si r5 = 0)
HE2	0	999	min	duración máxima energy saving -1 = hasta la apertura de la puerta

LABEL	MIN.	MAS.	U.M.	ENERGY SAVING EN TIEMPO REAL (si r5 = 0)
H01	0	23	h	horario energy saving diario
H02	0	24		duración máxima energy saving diario

LABEL	MIN.	MAS.	U.M.	DESESCARCHE EN TIEMPO REAL (si d8 = 4)
Hd1	-	-	-	horario 1er desescarche diario h- = desactivado
Hd2	-	-	-	horario 2er desescarche diario h- = desactivado
Hd3	-	-	-	horario 3er desescarche diario h- = desactivado
Hd4	-	-	-	horario 4er desescarche diario h- = desactivado
Hd5	-	-	-	horario 5er desescarche diario h- = desactivado
Hd6	-	-	-	horario 6er desescarche diario h- = desactivado

LABEL	MIN.	MAS.	U.M.	DISPOSITIVOS DE SEGURIDAD
Pbu	0	2	-	seleccionar evento para activar buzzer 0 = desactivado 1 = alarma 2 = botones y alarmas
POF	0	1	-	activar tecla ON/STANDBY 0 = no 1 = sí
PAS	-99	999	-	contraseña
PA1	-99	999	-	contraseña 1er nivel
PA2	-99	999	-	contraseña 2o nivel





LABEL	MIN.	MAS.	U.M.	RELOJ
POF	0	1	-	activar reloj 0 = no 1 = sí

LABEL	MIN.	MAS.	U.M.	REGISTRO DE DATOS EVLINK
bLE	0	99	-	configuración de puerto serie para conectividad 0 = desocupada 1 = forzado para Evconnect o EPoCA 2-99 = dirección de red local EPoCA
rE0	0	240	min	intervalo muestreo registrador de datos
rE1	0	5	-	selección temperatura para registrador de datos 0 = ninguna 1 = cámara 2 = evaporador 3 = auxiliar 4 = cámara y evaporador 5 = todas

LABEL	MIN.	MAS.	U.M.	MODBUS
LA	1	247	-	dirección MODBUS
Lb	0	3	-	baud rate MODBUS 0 = 2.400 baud 1 = 4.800 baud 2 = 9.600 baud 3 = 19.200 baud igualdad even

GESTIÓN HUMEDAD (sólo en equipos Pastry & Bakery)





Es posible decidir el valor de humedad que se desea según el tipo de alimentos que se desea conservar:

- Asegurarse que el teclado no esté bloqueado y que no exista ningún problema
- Tocar el botón **FNC**  por 2 s: la pantalla mostrará la etiqueta de ajuste de humedad (**rH⁻** = *alta humedad* o **rH⁻** = *baja humedad*)
- Tocar el botón **SET**  per 2 s para cambiar la configuración
- Tocar el botón   para confirmar y salir del procedimiento.

ALARMAS E SEÑALIZACIONES

TEMPERATURA NORMAL “0/+10°C” “+2/+10°C”

Señalizaciones

LED	SIGNIFICADO
	LED compresor si está encendido, significa que el compresor está encendido si parpadea: - está en curso la programación del setpoint de trabajo - está en curso una protección del compresor
	LED descongelación si está encendido, está activada la descongelación si parpadea, está activado el goteo
	LED ahorro de energía si está encendido y la pantalla está encendida, está activa la función “energy saving” si está encendido y la pantalla está apagada, está activo el modo “bajo consumo”; tocar un botón para restablecer la visualización normal
°C	LED grados Celsius si está encendido, la unidad de medida de la temperatura es en grados Celsius
°F	LED grados Fahrenheit si está encendido, la unidad de medida de la temperatura es en grados Fahrenheit
	LED on/stand-by si está encendido, el dispositivo está apagado (estado “stand-by”)

Indicaciones

CODICE	SIGNIFICADO
Loc	el teclado está bloqueado
- - -	el funcionamiento solicitado no está disponible
dEF	está activada la descongelación

Alarmas

CODICE	SIGNIFICADO
AL	Alarma de temperatura mínima Soluciones: - comprobar la temperatura ambiente; véase el parámetro A1 Principales consecuencias: - el dispositivo seguirá funcionando regularmente
AH	Alarma de temperatura máxima Soluciones: - comprobar la temperatura ambiente; véase el parámetro A4 Principales consecuencias: - el dispositivo seguirá funcionando regularmente
id	Alarma entrada micro puerta Soluciones: - comprobar las causas que han generado la activación de la entrada; véanse los parámetros i0 y i1 Principales consecuencias: - el efecto establecido con el parámetro i0 - la salida de alarma será activada

dFd	Alarma descongelación concluida por duración máxima Soluciones: - comprobar el buen estado de la sonda evaporador, consultar los parámetros d2, d3 y d11 - tocar un botón para restablecer la visualización normal Principales consecuencias: - el dispositivo seguirá funcionando regularmente
------------	---

Cuando la causa que ha generado la alarma desaparece, el dispositivo restablece el funcionamiento normal, salvo el caso de las siguientes alarmas:

- la alarma compresor bloqueado (código "CSd") que requiere el apagado del dispositivo o la interrupción de la alimentación
- la alarma descongelación concluida por duración máxima (código "dFd") que requiere el toque de un botón.





Errores

CODICE	SIGNIFICADO
Pr1	Error sonda ambiente Soluciones: - comprobar que la sonda sea de tipo PTC o NTC; véase el parámetro P0 - controlar la conexión dispositivo-sonda - controlar la temperatura ambiente Principales consecuencias: - la actividad del compresor dependerá de los parámetros C4 y C5 - la descongelación no será activada
Pr2	Error sonda evaporador o sonda condensador Soluciones: - las mismas del caso anterior pero relativos a la sonda evaporador o a la sonda condensador Principales consecuencias: - si el parámetro P4 se programa en 1, la descongelación durará el tiempo establecido con el parámetro d3 - si el parámetro P4 se programa en 1 y el parámetro d8 se programa en 2 o 3, el dispositivo funcionará como si el parámetro d8 estuviese programado en 0 - si el parámetro P4 se programa en 2, la alarma condensador sobrecalentado (código "COH") no será activada - si el parámetro P4 se programa en 2, la alarma condensador bloqueado (código "CSd") no será activada

Cuando la causa que ha generado el error desaparece, el dispositivo restablece el funcionamiento normal.

TEMPERATURA NORMAL "-2/+10°C" "-2/+8°C" - BAJA TEMPERATURA "-24/-12°C"

Señalizaciones

LED	SIGNIFICADO
	LED compresor si está encendido, significa que el compresor está encendido si parpadea: - está en curso la programación del setpoint de trabajo - está en curso una protección del compresor
	LED descongelación si está encendido: - está activada la descongelación - estará en curso el pre-goteo si parpadea: - se solicitará la descongelación pero estará en curso una protección del compresor - estará en curso el goteo - se solicitará la descongelación pero estará en curso un encendido mínimo del compresor
	LED ventilador del evaporador si está encendido el ventilador del evaporador estará encendido si parpadea estará en curso la parada ventilador del evaporador
HACCP	LED alarma HACCP memoria EVlink
AUX	LED auxiliar si está encendido: - las resistencias antivaho se encenderán
	LED energy saving si está encendido y la pantalla está encendida, está activa la función "energy saving" si está encendido y la pantalla está apagada, está activo el modo "bajo consumo"; tocar un botón para restablecer la visualización normal
	LED mantenimiento si está encendido, se indica el mantenimiento del compresor
°C	LED grados Celsius si está encendido, la unidad de medida de la temperatura es en grados Celsius
°F	LED grados Fahrenheit si está encendido, la unidad de medida de la temperatura es en grados Fahrenheit

	LED on/stand-by si está encendido, el dispositivo está apagado (estado "stand-by")
---	--

Indicaciones

CODICE	SIGNIFICADO
Loc	el teclado está bloqueado
- - -	el funcionamiento solicitado no está disponible

Alarmas

CODICE	SIGNIFICADO
rtc	Alarma reloj Soluciones: ajustar la fecha, la hora y el día de la semana
AL	Alarma de temperatura mínima Soluciones: - comprobar la temperatura ambiente o la temperatura CPT; véase el parámetro A1 Principales consecuencias: - la salida de alarma será activada
AH	Alarma de temperatura máxima Soluciones: - comprobar la temperatura ambiente o la temperatura CPT; véase el parámetro A4 Principales consecuencias: - la salida de alarma será activada
id	Alarma entrada micro puerta Soluciones: - comprobar las causas que han generado la activación de la entrada; véanse los parámetros i0 y i1 Principales consecuencias: - el efecto establecido con el parámetro i0 - la salida de alarma será activada
PF	Alarma power failure Soluciones: - tocar una tecla - comprobar la conexión eléctrica
dFd	Alarma descongelación concluida por duración máxima Soluciones: - comprobar el buen estado de la sonda evaporador, consultar los parámetros d2, d3 y d11 - tocar un botón para restablecer la visualización normal Principales consecuencias: - el dispositivo seguirá funcionando regularmente

Cuando la causa que generó la alarma desaparece, el dispositivo restablece el funcionamiento normal, salvo para las siguientes alarmas:

- la alarma compresor bloqueado (código "CSd") y la alarma protección térmica global (código "th") que necesitan el apagado del dispositivo o la interrupción de la alimentación
- la alarma descongelación concluida por una duración máxima (código "dFd") que necesita el toque de un botón.

Errores

CODICE	SIGNIFICADO
Pr1	Error sonda ambiente o sonda aire en entrada Soluciones: - comprobar que la sonda sea de tipo PTC o NTC; véase el parámetro P0 - controlar la conexión dispositivo-sonda - controlar la temperatura ambiente/la temperatura CPT Principales consecuencias: - la actividad del compresor dependerá de los parámetros C4 y C5 - si el parámetro P4 se programa en 3, la temperatura asociada a la regulación y a las alarmas de temperatura será la temperatura del aire en salida - la descongelación no será activada - la salida de alarma será activada - las resistencias de la puerta serán apagadas - la resistencias para el funcionamiento en zona neutra se apagarán
Pr2	Error sonda evaporador Soluciones: - las mismas del caso anterior pero relativos a la sonda evaporador Principales consecuencias: - si el parámetro P3 se programa en 1, la descongelación durará el tiempo establecido con el parámetro d3 - si el parámetro P3 se programa en 1 y el parámetro d8 se programa en 2 o 3, el dispositivo funcionará como si el parámetro d8 estuviese programado en 0 - si el parámetro P3 se programa en 1 o 2 el parámetro F0 se programa en 3 o 4, el dispositivo funcionará como si el

parámetro estuviere programado en2
- la salida de alarma será activada

Cuando la causa que ha generado el error desaparece, el dispositivo restablece el funcionamiento normal.

DESCONGELATION

LA DESCONGELACION DE LOS APARATOS ES COMPLETAMENTE AUTOMATICA.

La descongelación de las instalaciones de "NORMAL TEMPERATURA 0/+10°C ÷ +2/10°C" es a aire y se realiza automáticamente cada 6 horaas. La descongelación dura 20 minutos.

La descongelación de las instalaciones de "NORMAL TEMPERATURA -2/+10°C ÷ -2/+8°C" es de resistencia y se realiza automáticamente cada 6 horas. La duración del ciclo de descongelación está regulada por el aparato.

La descongelación de las instalaciones de "BAJA TEMPERATURA -24/-12°C" es a gas caliente y se realiza automáticamente cada 6 horas de funcionamiento del compresor. La duración del ciclo de descongelación está regulada por el aparato.

De todos modos es posible activar en cualquier momento un cilco de desescarche apretando por 5 segundos el boton "▲❄"; el desescarche automático siguiente se hará a partir de este momento despues de 6 horas para instalaciones de "NORMAL TEMPERATURA" y 6 horas de funcionamiento del compresor para instalaciones de "BAJA TEMPERATURA".

CARGA DEL PRODUCTO

- Distribuir el producto en el interior de los vanos refrigerados de manera uniforme para permitir una buena circulación del aire;
- Evitar obstruir las zonas de ventilación de la instalación de refrigeración colocado sobre la parte izquierda del vano;
- Evitar guardar los alimentos que necesitan bajas temperaturas de conservación en el último cajón inferior derecho;
- Cubrir o envolver los alimentos antes de introducirlos en el interior del aparato con adecuadas películas protectoras;
- No introducir en el aparato alimentos o bebidas demasiado calientes;
- No dejar las puertas abiertas más de lo necesario durante el retiro o la introducción de los alimentos;
- Almacenar los productos en la rejilla superior solamente hasta el límite de carga;
- No coloque productos por debajo del soporte del estante inferior.
- *Modelos Snack:* al cargar los cajones inferiores no se sobrepase el límite de carga.

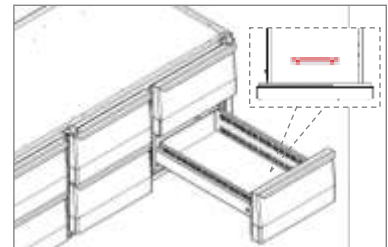
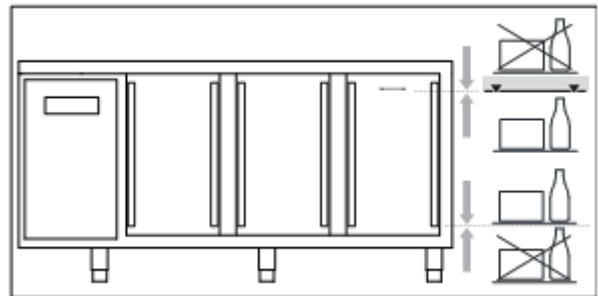

PARADA

En cualquier condición y para parar el equipo, basta apretar poniéndolo en posición OFF el interruptor general 1.

ATENCIÓN: la tecla de interruptor general 1 NO aísla el equipo de la tensión eléctrica.

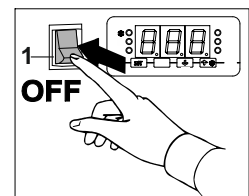

Poner el interruptor de línea en la posición OFF.

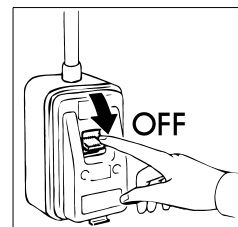

Para aislar la cabina de la tensión eléctrica, desenchufarla del tomacorriente de red.

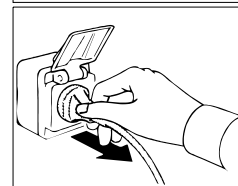

ANORMALIDADES DE FUNCIONAMIENTO

En el caso de funcionamiento irregular, antes de llamar al servicio asistencia de zona, controlar que:

- el interruptor general 1 esté iluminado y que haya tensión de red;
- el valor de la temperatura determinada sea el deseado;
- las puertas estén perfectamente cerradas;
- el equipo no esté cerca de fuentes de calor;
- el condensador esté limpio y el ventilador funcione regularmente;
- no haya demasiado hielo en la placa evaporadora.

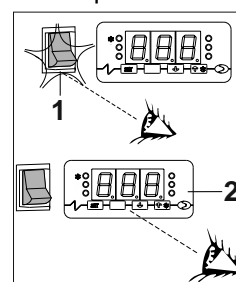

En caso que dichos controles hayan dado un resultado negativo, diríjase al servicio de asistencia de zona suministrando las indicaciones del modelo y número de matrícula colocados en la placa de las características.

INTERRUPCIONES EN EL FUNCIONAMIENTO

En caso de prolongada inactividad de la cabina y para mantenerla en las mejores condiciones, seguir estas indicaciones:

- llevar el interruptor de red a la posición OFF.
- desenchufar el aparato.
- vaciar la cabina frigorífica y limpiarla como indicado en el capítulo "LIMPIEZA".
- dejar las puertas de las celdas entreabiertas para evitar que tomen mal olor.

PROBLEMAS DE FUNCIONAMIENTO

A denudo, las dificultades de funcionamiento que se presentan, son ocasionadas por causas banales, que se pueden solucionar sin la intervención de un técnico especializado, por tanto, antes de llamar la red de asistencia por una avería, controlar lo siguiente:

PROBLEMA	CAUSAS POSIBLES
El aparato no se enciende	Controlar que esté enchufado correctamente
	Controlar que a la toma llegue corriente
La temperatura interna es demasiado elevada	Verificar la regulación del termostato
	Verificar que no haya una fuente de calor cercana
	Verificar que la puerta cierre correctamente
El aparato es excesivamente ruidoso	Verificar la nivelación del mismo. Una posición no equilibrada podría originar vibraciones
	Controlar que el aparato no esté en contacto con otros aparatos o partes que podrían entrar en resonancia
En el interior del frigorífico hay olores desagradables	Hay alimentos con olor muy fuerte (por ejemplo queso y melón), en recipientes no herméticos
	Las superficies internas deben limpiarse

Sobre el aparato se forma condensación	La humedad ambiente es muy elevada
	No se han cerrado bien las puertas

Realizar las verificaciones arriba indicadas, si el desperfecto continúa, dirigirse a la asistencia técnicas, recordando de señalar:

- la naturaleza del defecto
- el modelo y el número de matrícula del aparato que se pueden observar en la placa de las características eléctricas, puesta bajo la pared interna del aparato.

FICHA TÉCNICA DEL REFRIGERANTE

R290

GWP = 3

ODP = 0

❖ Identificación de los peligros

Gas licuado – Extremamente inflamable

❖ Medidas de primeros auxilios

• Inhalación:

En alta concentración puede causar asfixia. Los síntomas pueden incluir pérdida de movilidad y/o conocimiento. Las víctimas pueden no darse cuenta de la asfixia. En bajo nivel de concentración puede tener un efecto narcótico. Los síntomas pueden incluir mareos, dolor de cabeza, náusea y pérdida de la coordinación. Desplazar la víctima en una zona no contaminada usando un respirador. Mantener el paciente acostado y en un lugar cálido. Llame a un médico. En caso de paro respiratorio, realizar respiración artificial.

• Contacto con la piel o con los ojos:

En caso de derrame, lavar con agua durante como mínimo 15 minutos.

• Ingestión:

Vía de exposición poco probable

❖ Informaciones ecológicas

No se conocen daños en el ambiente provocados por este producto

PLACA ESQUEMA ELECTRICO

El esquema eléctrico se muestra sobre la última página del libro.

Pos	DESCRIPCIÓN	Pos	DESCRIPCIÓN
1	COMPRESOR	20C	RESISTENCIA ANTICONDENSACION PUERTAS
2	VENTILADOR CONDENSADOR	21	RESISTENCIA DESPOSIT.DESCONG.
3	TABLERO DE BORNES	22	RESISTENCIA FONDO BANDEJAS
6	INTERRUPTOR GENERAL	44	RELAIS COMPRESOR
8	TOMA ELÉCTRICA	69	BORNE DE TIERRA
9	VENTILADOR EVAPORADOR	75	ELÉCTROVALVULA
12	ELECTROVÁLVULA DISPOSIT.DESCONG.	88	TERMOREG. DGT
20	RESISTENCIA ANTICONDENSACION PUERTAS	90	TERMOREG. DGT
20A	RESISTENCIA ANTICONDENSACION PUERTAS	102	TERMOSTATO DE SEGURIDAD
20B	RESISTENCIA ANTICONDENSACION PUERTAS		

INDEX

VEILIGHEIDSINFORMATIE.....	2
VEILIGHEIDSVOORSCHRIFTEN	2
BESCHRIJVING APPARAAT	4
IDENTIFIKATIE ETIKET	4
AFMETINGEN.....	5
IN WERKING STELLEN EN INSTALLATIE.....	7
ALGEMENE REINIGING EN ONDERHOUD.....	8
ONDERHOUD APPARATEN ROESTVRIJ STAAL	8
ONDERHOUD APPARATEN VX-PET	10
HET AFVALMATERIAAL LOZEN EN HET APPARAAT AFDANKE.....	10
ALGEMENE OPMERKINGEN BIJ DE LEVERING	11
ACCESSOIRES	11
HACCP VOORSCHRIFTEN	11
TECHNISCHE KENMERKEN	12
BEDIENINGSPANELEN	13
AANSLUITING EN FUNKTIONEREN	13
BLOKKERING/DEBLOKKERING VAN HET TOETSENBORD	13
INTELWAARDE EN CONFIGURATIEPARAMETERS	14
VOCHTIGHEIDSMANAGEMENT' (<i>uitsluitend op apparaten Pastry & Bakery</i>).....	21
ALARMSIGNALLEN	21
ONTDOOIEN.....	24
INLEGGEN VAN PRODUCTEN.....	24
UITZETTEN.....	24
ONREGELMATIGHEDEN IN DE WERKING.....	25
GEBRUIKSONDERBREKINGEN.....	25
STORINGEN IN DE WERKING.....	25
SPECIFICATIES VAN DE KOELVLOEISTOF	26
BESCHRIJVING ELEKTRISCH SCHEMA.....	26

VEILIGHEIDSINFORMATIE

WAARSCHUWING: Dit apparaat bevat koolwaterstofkoelmiddelen (R290).

GEVAAR: Vuur- of explosiegevaar. Ontvlambaar koelmiddel in gebruik. Gebruik geen mechanische apparatuur om de koelkast te ontdooien. Koelmiddelleidingen mogen niet doorboord worden.

GEVAAR: Vuur- of explosiegevaar. Ontvlambaar koelmiddel in gebruik. Reparatie alleen door vakpersoneel. Koelmiddelleidingen mogen niet doorboord worden.

LET OP: Vuur- of explosiegevaar. Ontvlambaar koelmiddel in gebruik. Volg de reparatiehandleiding/ gebruikshandleiding voor service aan dit product. Alle veiligheidsvoorschriften moeten opgevolgd worden.

LET OP: Vuur- of explosiegevaar. Verwijdering van de koelkast alleen volgens geldende voorschriften. Ontvlambaar koelmiddel in gebruik.

LET OP: Vuur- of explosiegevaar wanneer koelmiddelleidingen doorboord worden; volg de instructies in de handleidingen. Ontvlambaar koelmiddel in gebruik.

LET OP: Niet blokkeren. Alle ventilatieopeningen in de nabijheid moeten vrij blijven als het apparaat is ingebouwd.

LET OP: Bewaar in dit apparaat geen ontplofbare stoffen zoals spuitbussen met een ontvlambaar drijfgas



Aanduiding licht ontvlambaar door de aanwezigheid van een brandbaar koelmiddel (R290)

De instructies zijn beschikbaar op de website www.sagispa.it.

VEILIGHEIDSVOORSCHRIFTEN

De apparaten zijn voorzien van een voedingskabel met stekker.

LET OP: bij iedere handeling van reiniging en onderhoud dient de stroom uitgeschakeld te worden:

– de hoofdschakelaar op OFF zetten.

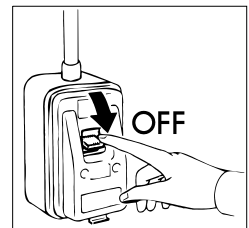

– de stekker uit het stopcontact trekken. Het verwijderen van de plug moet zodanig zijn dat de operator vanaf ieder werkpunt de uitschakeling kan controleren.

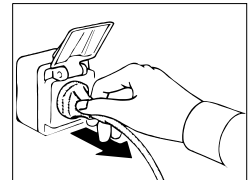

LET OP: geen niet-geaarde stekkers of stopcontacten gebruiken.

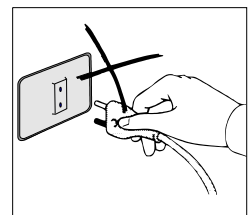

Het netstopkontakt moet geaard zijn.

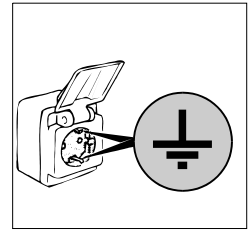

LET OP: geen adapters of verlengsnoeren gebruiken voor aansluiting aan het net.

LET OP: wanneer de voedingskabel is beschadigd moet deze worden vervangen door de fabrikant, een klantenservice of gekwalificeerd personeel, om risico's te voorkomen.

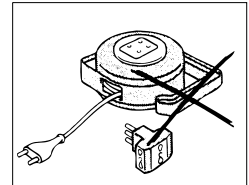

De reiniging en het onderhoud van het koelsysteem en van de kompressorruimte moet door een gespecialiseerd technicus gebeuren, en kan daarom niet door ongeschikt personeel worden uitgevoerd.



Tijdens handelingen van onderhoud of in het geval van onregelmatigheden, het apparaat geheel uitzetten; Vraag om tussenkomst van de REPARATIEDIENST van een daartoe bevoegd centrum en het gebruik van originele reserveonderdelen. Gebeurt dit niet, dan kan dit de veiligheid van het apparaat in gevaar brengen.

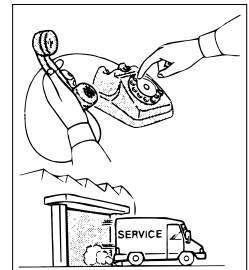

LET OP: wacht na de inwerkingstelling de tijd die nodig is om de ingestelde temperatuur te bereiken voordat het te conserveren voedsel wordt ingebracht.

Etenswaaren moeten altijd op de juiste manier verpakt zijn alvorens ze in het apparaat worden gezet.

LET OP: geen warme dranken of etenswaren in het apparaat zetten.

LET OP: Niet schoonmaken in de buurt van het apparaat als de deur geopend is.

Het apparaat niet met plenzen water of water onder hoge druk schoonmaken.

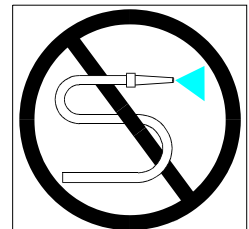

LET OP: geen substanties gebruiken bij de reiniging of in de buurt van het apparaat die chloor bevatten (bleekmiddel, zoutzuur, enz.) of die giftig zijn.

LET OP: gebruik alleen mechanische apparaten of andere middelen om het ontdooien te versnellen die zijn aanbevolen door de fabrikant.

LET OP: gebruik geen elektrische apparaten in de bewaarruimten.

De apparatuur is ontworpen voor een geluidsdruk niveau lager dan 70dB (A).



BESCHRIJVING APPARAAT

Dit apparaat is ontworpen voor het koelen en het bewaren van levensmiddelen. Elk ader gebruik moet als oneigenlijk beschouwd worden.

LEP OP: de apparaten zijn niet geschikt om buiten geïnstalleerd te worden of op plaatsen die aan de inwerking van weersinvloeden blootgesteld zijn.

De fabrikant kan op geen enkele wijze aansprakelijk gesteld worden voor onjuist gebruik van de producten.

De basiselementen hebben aan de bovenkant een werkblad, dat ook beschikbaar is met achtersteuntjes: ze zijn ook beschikbaar zonder blad met soortgelijke koelvermogens.

Het bedieningspaneel is voorzien van digitale temperatuurregeling en algemene schakelaar.

De motoreenheid bevindt zich links van het basiselement in een geschikte ruimte.

De verdampers bevinden zich binnen in de koelruimte, één voor iedere ruimte, en wordt afgeschermd met geschikte metaalplaten.

De interne ventilatie wordt gerealiseerd met beveiligde boven de verdampers geplaatste tangentiële ventilatoren.

Het apparaat verdampt de condens automatisch.

De gedeelten die met de levensmiddelen in aanraking komen zijn gemaakt van staal of bekleed met kunststof materiaal dat niet giftig is.

Zorg bij opslag voor goede ventilatie, temperaturen tussen -20 °C en 50 °C, relatieve luchtvochtigheid tussen 30% en 80% en een niet stoffige, droge omgeving.

IDENTIFIKATIE ETIKET

Het identificatie-etiket zit definitief op het product en levert een serie belangrijke aanwijzingen over de technische en constructieve kenmerken van het product.

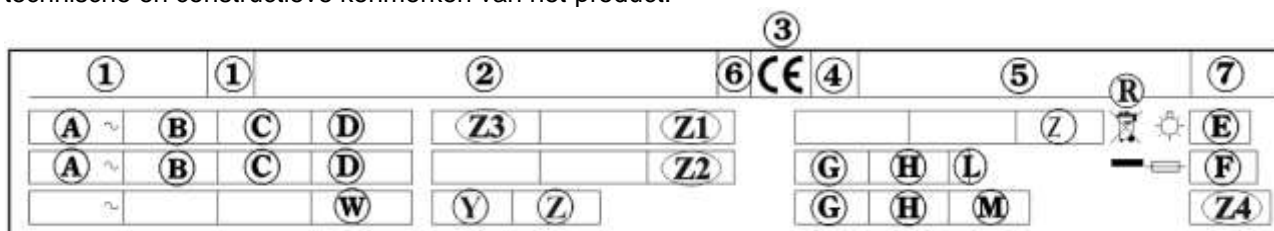

INHOUD VAN DE VAKJES VAN HET TECHNISCHE PLAATJE

- | | |
|-----------------------------------|--------------------------------------|
| 1) MODEL | E) TOTALE KRACHT VERLICHTING |
| 2) NAAM EN ADRES VAN FABRIKANT | F) ZEKERINGSSTROOM |
| 3) EG HERKENNINGSTEKEN | G) TYPE KOELGAS |
| 4) BOUWJAAR | H) HOEVEELHEID KOELGAS |
| 5) REGISTRATIENUMMER | L) TEMPERatuurKLASSE KOELINSTALLATIE |
| 6) KLASSE ELEKTRISCHE ISOLATIE | W) KRACHT WARMTE-ELEMENTEN |
| 7) KLASSE ELEKTRISCHE BESCHERMING | Z1) NETTO-VOLUME (RSV) |
| A) SPANNING ELEKTRISCHE VOEDING | Z2) FLUID FOAMING |
| B) INTENSITEIT ELEKTRISCHE STROOM | Z3) BEDRIJFSTEMPERATUUR |
| C) FREKWENTIE | Z4) GWP |
| D) NOMINALE KRACHT | |

Klimaatklasse *	Omgevingstemperatuur
3 (SN)	+10°C ---> +32°C
4 (N)	+16°C ---> +32°C
4+ (ST)	+16°C ---> +38°C
4+ (SN-ST)	+10°C ---> +38°C
5 (T)	+16°C ---> +43°C
5 (SN-T)	+10°C ---> +43°C

(*) De klimatologische temperatuurklasse geeft de omgevingstemperatuur aan waarop het apparaat kan werken.

AFMETINGEN

Zie de afmetingen van Uw apparaat.

- *Dieptemodellen 600*

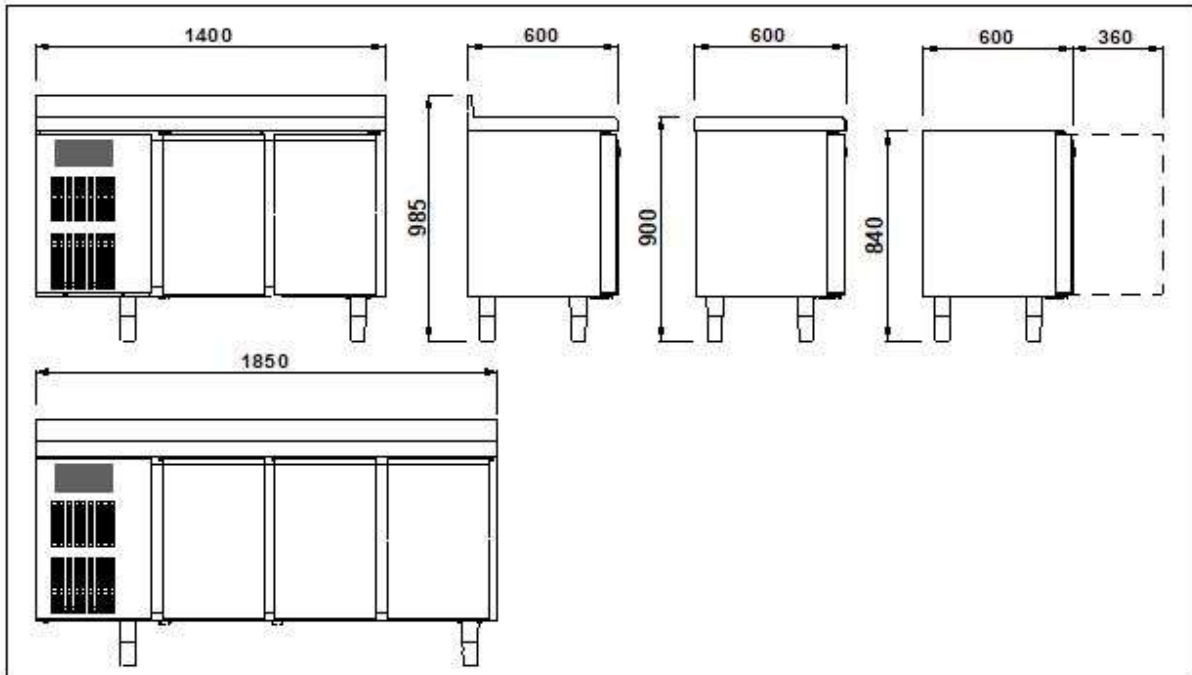

- *Dieptemodellen 700*

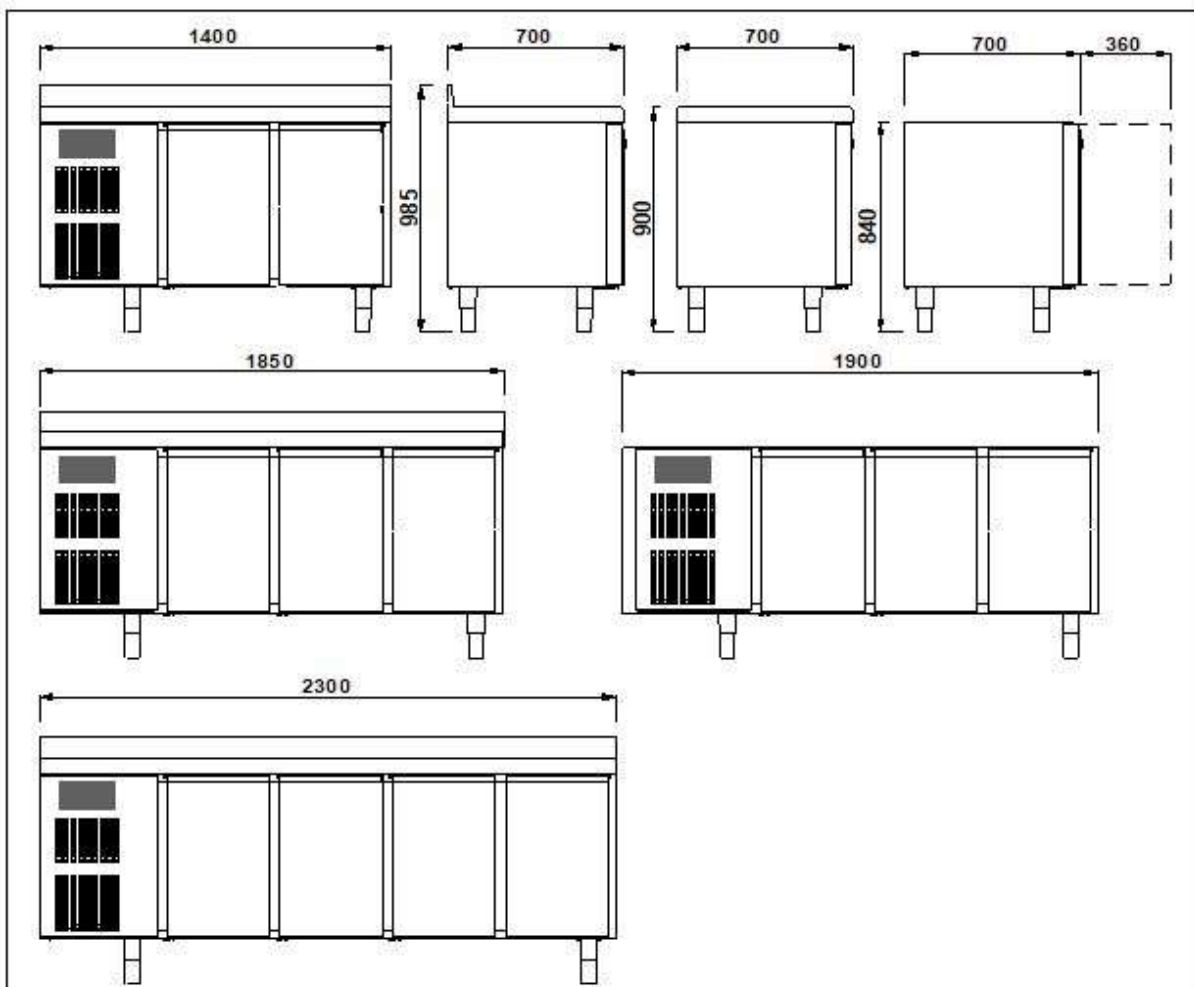

- *Modellen snack*

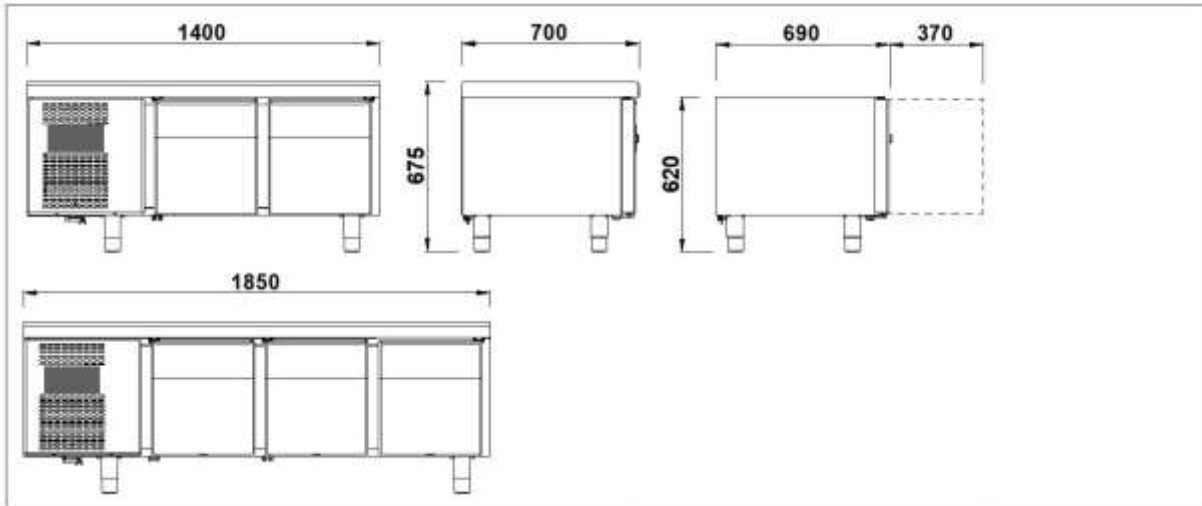

- *Modellen pastry & bakery*

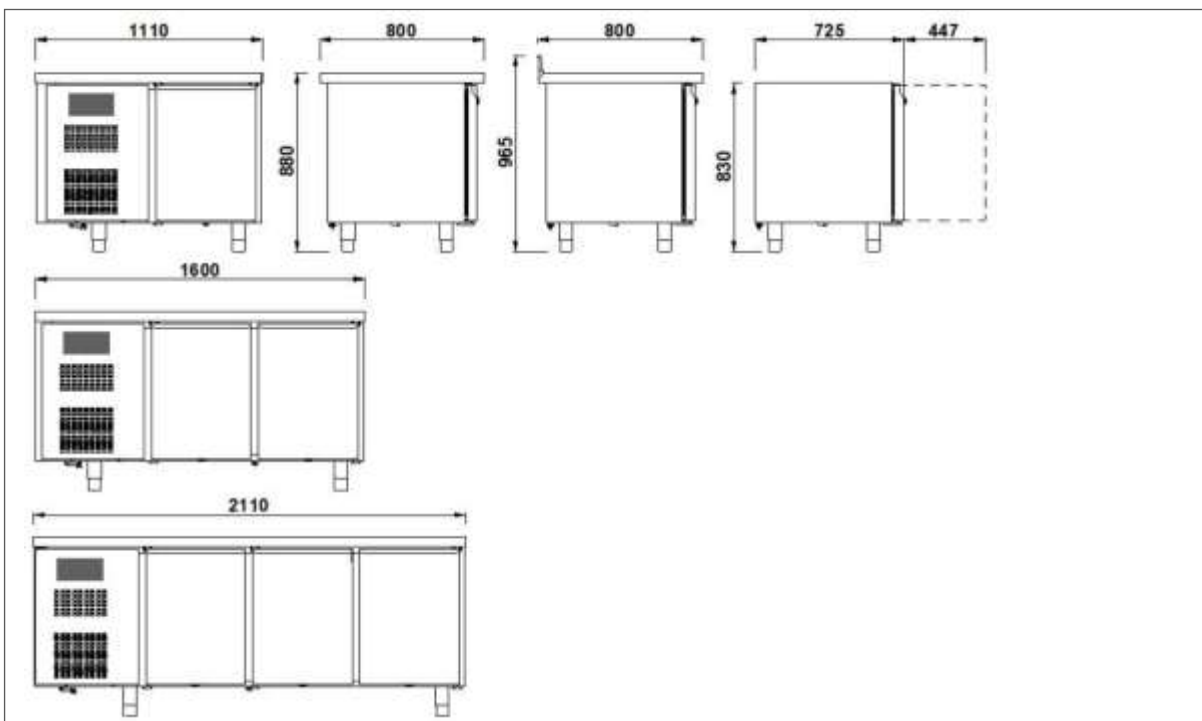

- *Modellen pizza*

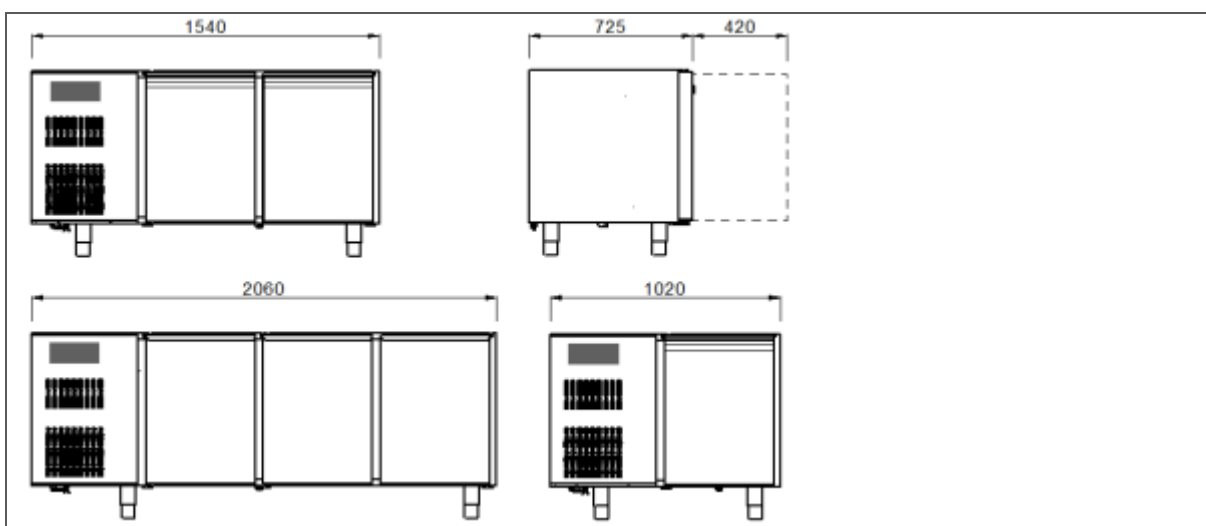

IN WERKING STELLEN EN INSTALLATIE

De apparaten worden altijd ingepakt en op palets verzonden.

Bij ontvangst en na het apparaat uitgepakt te hebben, gelieve zich te gedragen in geval van schade of ontbrekende delen, zoals beschreven in het hoofdstuk "ALGEMENE OPMERKINGEN BIJ DE LEVERING".

Het in werking stellen en de installatie moet door gespecialiseerd personeel uitgevoerd worden.



De verpakkingendoos verwijderen waarbij opgepast moet worden niet de oppervlakken van het apparaat te deuken.

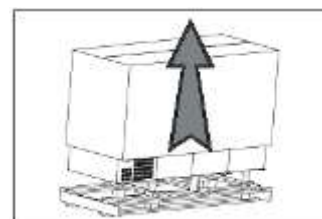

OPGELET: de verpakkingsonderdelen (plastic zakken, schuimrubber, spijkers e.d.) moeten buiten het bereik van kleine kinderen worden gehouden, omdat zij gevaarlijk kunnen zijn.

Met een vorkheftruck het apparaat optillen en naar de installatieplek brengen, waarbij men oplet, dat de last in evenwicht is.

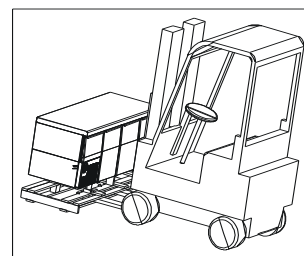

LET OP: zowel bij de plaatsing op de installatieplek als bij toekomstige verplaatsingen het apparaat niet duwen of slepen, om te vermijden, dat het omvalt, of schade te berokkenen aan enig onderdeel daarvan.

LET OP: het apparaat niet in de buurt van warmtebronnen of in ruimten met hoge temperaturen plaatsen; dat zou een lager rendement ervan of een buitengewone belasting voor de koelinstallatie kunnen veroorzaken.



Plaats het apparaat in de eindpositie.

Zorg ervoor dat de ruimte voldoende geventileerd is. Wijs geen apparatuur toe aan omgevingen boven de aangegeven klimaatklasse.

De beschermfolie van het product verwijderen. Deze handeling kan vervelende zijn het ongevaarlijke schokken veroorzaken (statische electriciteit). Dit ongemak maakt men ongedaan of vermindert men behoorlijk door altijd met één hand contact te houden met het apparaat of door het buitenomhulsel met de vloer te verbinden.

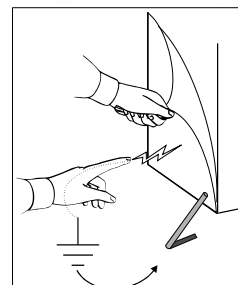

Nu kan men de voetjes van het apparaat regelen om dit te nivelleren.

Het apparaat nivelleren door het iets naar achteren te laten leunen om de optimale sluiting van de deuren te bevorderen.

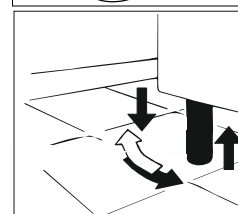

Met lauwwarm water en neutrale zeep schoonmaken (zoals beschreven in het hoofdstuk "REINIGING") en de eventuele accessoires monteren.

Controleren, of de netspanning overeenkomt met degene, die op het plaatje met de technische kenmerken van het apparaat aangegeven is.

LET OP: controleren, of het netstopcontact geaard is; in geval van niet daarvoor zorgen.

Dan de stekker in het betreffende netstopcontact steken.

De apparatuur moet ook op een equipotentiaal systeem aangesloten zijn, waarvan de efficiëntie volgens de geldende normen gecontroleerd moet zijn. De aansluiting wordt uitgevoerd door middel van een met het "Equipotentiaal"-teken gemerkte schroef, die in de compressorenruimte aangebracht is.

Nu zijn de werkzaamheden ter ingebruikname ten einde.

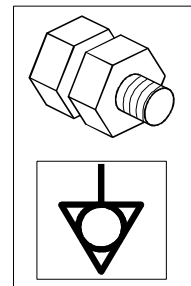

ALGEMENE REINIGING EN ONDERHOUD

Voor een konstant functioneren van het apparaat moeten handelingen van algemene reiniging en onderhoud worden verricht.

Voor hiermee te beginnen als volgt te werk gaan:

- de hoofdschakelaar op OFF zetten
- de stekker uit het stopcontact trekken en wachten tot het apparaat geheel ontdooid is.

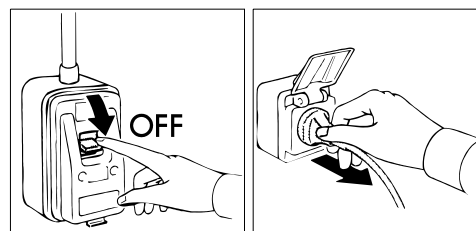

Met een stofzuiger, een penseel of een niet-metalen borstel zorgvuldig de koeleenheid en in het bijzonder de accu reinigen.

OPGELET: De reiniging en het onderhoud van het koelsysteem en van de kompressorruimte moet uitgevoerd worden door een gespecialiseerd en geautoriseerd technicus, en kan daarom niet worden uitgevoerd door ongeschikt personeel.

De oppervlakten aan de binnen- en buitenkant met water en zeep schoonmaken of met een neutraal schoonmaakmiddel; een beetje azijn in het water neemt eventuele vieze geuren weg. Afspoelen met ruimschoots schoon water en goed afdrogen.

De handelingen van algemene reiniging en onderhoud zijn nu beëindigd.

ONDERHOUD APPARATEN ROESTVRIJ STAAL

DAGELIJKSE REINIGING

Om een optimale hygiëne en behoud van de apparaat te garanderen is het raadzaam dagelijks, volgens de hieronder beschreven instructie, de koelkast schoon te houden:

1. de oppervlakten van de apparaat grondig schoonmaken met een zachte spons en water met een neutraal reinigingsmiddel, de spons uitwringen en alleen in de richting van de lak vegen.
2. gebruik geen bijtende schoonmaakmiddelen of reinigingsmiddelen die chloor bevatten.
 - 2.a wij raden U aan enkel de volgende reinigingsmiddelen te gebruiken:
 - desinfecterend reinigingsmiddel met meervoudige werking; (bevat niet-ionogene oppervlakte-actieve stoffen, benzalkoniumchloride, substanties met chelaat en pH tampon)

- reinigingsmiddel voor laboratoria, neutraal, voor handmatig reinigen; (bevat aniogene en niet-ionogene oppervlakte-actieve stoffen)
 - ontvettend reinigingsmiddel te gebruiken in omgevingen met etenswaren; (bevat aniogene oppervlakte-actieve stoffen en EDTA)
3. voor gebruik de reinigingsmiddelen eventueel verdunnen, volgens de gebruiksaanwijzingen vermeldt op het etiket.
 4. de reinigingsmiddelen minstens 5 min. laten inwerken.
 5. de wanden van de apparaat grondig naspoelen met een spons meerdere keren nat gemaakt onder stromend water.
 6. goed afdrogen met een schone doek.

OPGELET: Geen spullen gebruiken die op enigerlei wijze krassen kunnen veroorzaken wat roestvorming tot gevolg heeft.

VOEDSELVLEKKEN EN HARD GEWORDEN RESTEN

In het geval er etensvlekken of voedselresten in de apparaat aanwezig zijn deze met water schoonmaken en verwijderen voordat deze verharden.

Als de voedselresten reeds verhard zijn deze als volgt verwijderen:

1. gebruik een zachte spons gedompeld in lauw water met reinigingsmiddel (men kan dezelfde reinigingsmiddelen gebruiken als vermeldt voor de dagelijkse reiniging maar dan met hogere concentratie zoals vermeldt op het etiket).
2. de verharde voedselresten nat maken , zodat deze minstens 30 min. vochtig blijven, door ongeveer om de 5 min. de spons natgemaakt in water met reinigingsmiddel er overheen te vegen.
3. na het weken de resten wegvegen met de spons, natgemaakt in water met neutraal reinigingsmiddel.
4. indien nodig een houten spatel of een roestvrij stalen staalsponsje gebruiken, er aandacht aan bestedend de oppervlakte van de koelkast niet te beschadigen.
5. na deze specifieke reiniging is het raadzaam een algemene (dagelijkse) reiniging van alle interne oppervlakten van de apparaat uit te voeren.
6. aan het einde van de reiniging met een vochtige spons, veelvuldig gespoeld onder stromend water, de wanden vegen.
7. grondig afdrogen met een schone doek.

Ook de onderliggende gedeeltes moeten goed gereinigd en onderhouden worden voor een perfecte hygiene. Met water en zeep of neutraal schoonmaakmiddel reinigen.

Bescherm de beplating met siliconenwas.

NUTTIGE TIPS VOOR HET ONDERHOUD VAN ROESTVRIJ STAAL

Voor de reiniging en het onderhoud van de delen in roestvrij staal dient men het volgende in acht te nemen, er rekening mee houdend dat de belangrijkste voorwaarde het waarborgen van niet-giftigheid en hygiene van de produkten is.

Het roestvrij staal heeft een dun laagje oxyde wat de vorming van roest voorkomt. Er zijn verschillende substanties en schoonmaakmiddelen die deze laag kunnen beschadigen of krassen waardoor corrosie ontstaat. Voor een schoonmaakmiddel te gebruiken dient men eerst te informeren wat het meest geschikte neutrale schoonmaakmiddel is dat geen corrosie op staal veroorzaakt.

In het geval van krassen op de oppervlakten, moeten deze gepolijst worden met zeer fijne roestvrije staalwol of een schuur sponsje met synthetische vezels waarbij in de glansrichting gewreven moet worden.

OPGELET: Bij het reinigen van roestvrij staal nooit ijzeren voorwerpen gebruiken en deze ook niet op de oppervlakten laten liggen omdat zeer kleine ijzerhoudende deeltjes op de oppervlakte kunnen blijven liggen en zo roestvorming veroorzaken door besmetting, wat de hygiene verslechtert.

ONDERHOUD APPARATEN VX-PET

Om een optimale hygiene en behoud van de apparaat te garanderen is het raadzaam dagelijks, volgens de hieronder beschreven instructie.

Ingeval van aanwezigheid van etensresten of –vlekken op het buitenoppervlak, deze schoonmaken met water en verwijderen voordat ze indrogen.
Indien de resten reeds zijn ingedroogd, een zachte spons met terpentijn of gedenatureerde alcohol gebruiken.

Ingeval van aanwezigheid van etensresten of –vlekken op het interne oppervlak, deze schoonmaken met hete witte azijn of gedenatureerde alcohol en een zachte doek.
Schoonmaken in de glansrichting.

Aanbevolen wordt alle interne oppervlakten van het apparaat dagelijks schoon te maken.
Geen schuurmiddel of inox schuur sponsjes gebruiken. Geen aceton, trichloorethyleen en ammoniak gebruiken.

Aan het einde van de reiniging met een vochtige spons, veelvuldig gespoeld onder stromend water, de wanden vegen.

Grondig afdrogen met een schone doek.

Ook de onderliggende gedeeltes moeten goed gereinigd en onderhouden worden voor een perfecte hygiene.
Met water en zeep of neutraal schoonmaakmiddel reinigen.

HET AFVALMATERIAAL LOZEN EN HET APPARAAT AFDANKE

OPSLAG VAN HET AFVALMATERIAAL

Oude apparatuur mag niet worden vernietigd via de normale ongesorteerde afvalstroom. Alvorens het apparaat weg te gooien moeten eerst de deuren gedemonteerd worden.

Het afvalmateriaal mag tijdelijk opgeslagen worden in afwachting van het moment waarop de speciale afvalstoffen bij de vuilverwerkende instanties ingeleverd kunnen worden en/of definitief opgeslagen kunnen worden. De wettelijke bepalingen die in het land van de gebruiker van toepassing zijn ten aanzien van de bescherming van het milieu moeten in ieder geval in acht genomen worden.

PROCEDURE VOOR DE RUWE DEMONTAGE VAN HET APPARAAT

In die diverse landen zijn verschillende wetgevingen van toepassing. U moet dan ook de voorschriften die door de wetten en de instanties in het land waar het apparaat gesloopt wordt bepaald worden in acht nemen. In de meeste gevallen kan de oude koelkast bij de betreffende instanties die voor de inzameling/het slopen ervan zorgen ingeleverd worden. Haal de oude koelkast uit elkaar en scheid de diverse onderdelen al naar gelang de chemische samenstelling ervan, waarbij u er rekening mee moet houden dat er in de compressor smeerolie en koelmiddel zit en dat dit opgevangen kan worden en opnieuw gebruikt kan worden. Bovendien moet u er rekening mee houden dat de onderdelen van de koelkast speciaal vuil zijn dat niet bij het huisvuil gezet mag worden maar gescheiden moet worden.

Maak het apparaat volledig onbruikbaar door de voedingskabel en alle mogelijke sluitingen (waar aanwezig) te verwijderen om te voorkomen dat er iemand in opgesloten kan raken.

HET APPARAAT MOET IN IEDER GEVALDOOR VAKMENSEN GEDEMONTEERD WORDEN.

VEILIGHEID BIJ HET VERWERKEN VAN AFGEDANKTE ELEKTRISCHE EN ELEKTRONISCHE APPARATUUR (RICHTLIJN AEEA 2002/96/EG)

Verspreid geen vervuilende materialen in het milieu.

Deze materialen moeten worden verwerkt in overeenstemming met de betreffende geldende wetten.

Volgens de voorschriften van de richtlijn AEEA 2002/96/EG (afgedankte elektrische en elektronische apparatuur), moet de gebruiker, bij het afdanken ervan, de apparatuur in de speciale bevoegde verzamelcentra verwerken of ze op het moment van de nieuwe aankoop nog geïnstalleerd teruggeven aan de verkoper.

Alle apparaten die volgens de AEEA 2002/96/EG richtlijn moeten worden verwerkt zijn herkenbaar aan een

speciaal symbol .

De illegale verwerking van afgedankte elektrische en elektronische apparaten wordt bestraft met sancties geregeld door de geldende wetten in het gebied waar de overtreding geconstateerd wordt.

Afgedankte elektrische en elektronische apparaten kunnen gevaarlijke stoffen bevatten met potentieel schadelijke gevolgen voor het milieu en de gezondheid van de personen. Wij bevelen een correcte afvalverwerking aan.

ALGEMENE OPMERKINGEN BIJ DE LEVERING

Kontrolleren bij de levering dat de verpakking intact is en geen schade heeft opgelopen gedurende het transport.

Na het apparaat uitgepakt te hebben controleren of alle onderdelen aanwezig zijn en of de kenmerken voldoen aan hetgeen u besteld heeft. Mocht dit niet het geval zijn, gelieve onmiddellijk contact op te nemen met de verkoper.

Wij feliciteren U met uw uitstekende keuze en hopen op een optimaal gebruik van de koelkasten volgens de aanwijzingen en nodige voorzorgen vermeldt in deze gebruiksaanwijzing.

NB: nadruk van de gebruiksaanwijzing verboden.

Dankzij constant onderzoek en verbetering van de technologische kwaliteit kunnen de technische gegevens hier vermeld zonder voorafgaand bericht gewijzigd.

ACCESSOIRES

Op verzoek kan het apparaat worden uitgerust met de volgende accessoires ("*zie algemene catalogus*").

HACCP VOORSCHRIFTEN

OPGELET: rauwkost, eieren en gevogelte kunnen **NIET** in dezelfde koelvakken bewaard worden. Gevogelte moet apart bewaard worden in de daarvoor bestemde vakken.

OPGELET: Levensmiddelen met een temperatuur tussen de 10°C en 60°C niet in de koelkast plaatsen. De temperatuur in de kern van het produkt verlagen met de daarvoor bestemde apparatuur (versnelde invriezing).

OPGELET: Wanneer men levensmiddelen uit de koelkast neemt altijd de vervaldatum op de verpakking controleren en produkten die het eerst verlopen het eerst gebruiken. Een eventueel bedorven produkt uit de koelkast nemen en dit aan de bedrijfsleider melden.

OPGELET: Produkten die snel bedorven als laatste uit de koelkast nemen, zodat deze slechts voor korte tijd aan de omgevingstemperatuur blootgesteld worden.

OPGELET: Reeds ontdooide produkten niet opnieuw invriezen.

OPGELET: Instrumenten nummeren en tweemaal daags de temperatuur kontoleren.
De waarden op het daarvoor bestemde formulier invullen en 24 maanden bewaren.

OPGELET: Een digitale klok registreert eventuele stroomonderbrekingen, zodat beschadigde levensmiddelen verwijderd kunnen worden.

Maximaal toegestane temperatuur levensmiddelen

Levensmiddel	Normale opslagtemperatuur (°C)	Maximale temperatuur tijdens het transport (°C)
Verse gepasteuriseerde melk	0÷+4	9
Verse room	0÷+4	9
Yoghurt, ricotta, verse kaas	0÷+2	9
Gekoelde visprodukten	0÷+2	0÷+4
Runder- en varkensvlees	0÷+3	10
Gevogelte	0÷+4	8
Konijn	0÷+2	8
Klein wild	0÷+2	8
Groot wild	0÷+2	8
Orgaanvlees	0÷+3	8
Diepgevroren produkten	-23÷-24	-18
Ijs	-18÷-20	-18
Groente en fruit	0÷+4	omgevingstemperatuur

TECHNISCHE KENMERKEN

De technische gegevens kunt U vinden op the laaste pagina van de gebruiksaanwijzing.

BEDIENINGSPANELEN

Alle koelkasten zijn voorzien van een hoofdschakelaar en thermoregelaar:

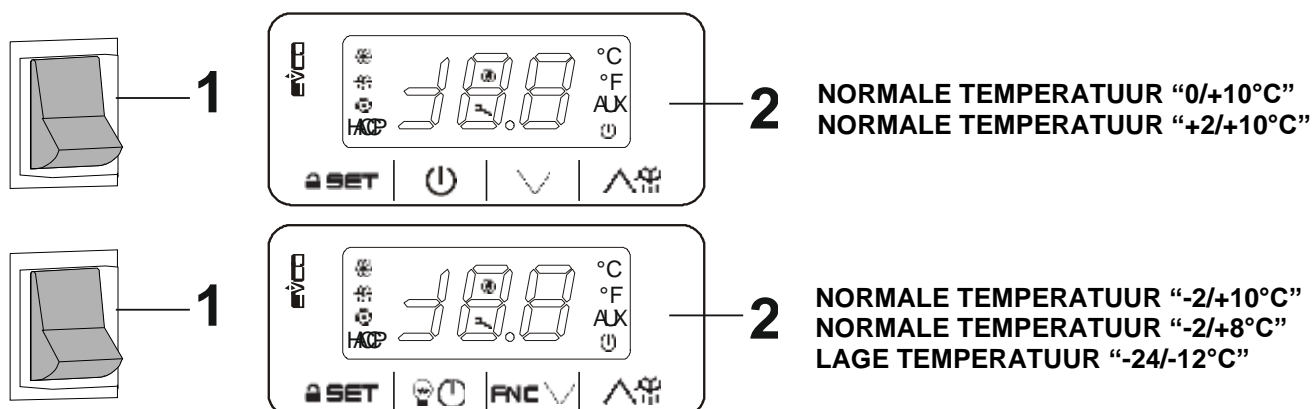

AANSLUITING EN FUNKTIONEREN

Om het apparaat op te starten, de volgende handelingen uitvoeren:

- de stekker in het stopkontakt stoppen;
- de netschakelaar op stand ON zetten;

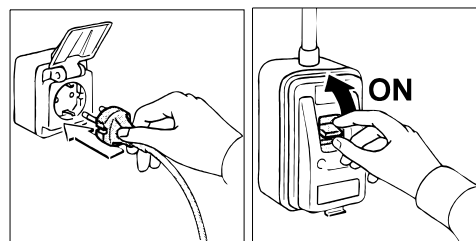

- op de hoofdschakelaar (1) drukken; het groene controlelichtje van de hoofdschakelaar zal gaan branden; dan is het mogelijk de werkt temperatuur in te stellen door middel van een geschikte instelling van de thermoregelaar (2).

Op het thermoregelaar-display (2), na verloop van de noodzakelijke tijd - controleren, of de interne temperatuur van de apparaten overeenkomt met de ingestelde temperatuur.

BLOKKERING/DEBLOKKERING VAN HET TOETSENBOORD

Blokkeren van het toetsenbord:

- controleer of er geen enkele procedure in gang is
- voer gedurende 30 seconden geen handeling uit: gedurende 1 sec. verschijnt "Loc" op de display.

Deblokkeren van het toetsenbord:

- druk 1 sec. op een toet : gedurende 1 sec. verschijnt "UnL" op de display

INSELWAARDE EN CONFIGURATIEPARAMETERS

NORMALE TEMPERATUUR "0/+10°C" "+2/+10°C"

Setting the working setpoint

- Make sure that the keyboard is not locked and that no procedure is in progress
- Touch the **SET** key: the LED will flash
- Touch the \wedge or \vee key within 15 s; see also r1 and r2 parameters
- Touch the **SET** key or do not operate for 15 s: the LED will switch off after which, the device will exit the procedure.

To exit the procedure before the operation is complete:

- Touch the \square (any changes will not be saved)

The working setpoint can also be set via **SP** parameter.

Working setpoints

LABEL	MIN.	MAS.	U.M.	WORKING SETPOINT
r1	r2		°C/°F (1)	working setpoint; see also r0 and r12

Setting the configuration parameters

To access the procedure:

- Make sure no procedure is in progress
- Touch the **SET** key for 4 s: the display will show "PA"
- Touch the **SET** key
- Touch the \wedge or \vee key within 15 s to set the value determined with the "PAS" parameter (the parameter is set at "-19" by default)
- Touch the **SET** or do not operate for 15 s: the display will show "SP"

To select a parameter:

- Touch the \wedge or \vee key

To set a parameter:

- Touch the **SET** key
- Touch the \wedge or \vee key within 15 s.
- Touch the **SET** key or do not operate for 15 s.

To exit the procedure:

- Touch the **SET** key for 4 s or do not operate for 60 s (*any changes will be saved*)

Configuration parameters

LABEL	MIN.	MAS.	U.M.	WORKING SETPOINT
SP	r1	r2	°C/°F (1)	working setpoint; see also r0 and r12

LABEL	MIN.	MAS.	U.M.	ANALOG INPUTS
CA1	-25	25	°C/°F (1)	room probe offset
CA2	-25	25	°C/°F (1)	if P4 = 1, evaporator probe offset if P4 = 2, condenser probe offset
P0	0	1	-	probe type (0 = PTC; 1 = NTC)
P1	0	1	-	degree Celsius decimal point (during normal operation) 1 = YES
P2	0	1	-	unit of measurement for temperature (2) 0 = °C (Celsius degree; resolution depends on P1 parameter) 1 = °F (Fahrenheit degree; resolution is 1 °F)
P4	0	2	-	second input function 0 = digital input (door switch or multifunction) 1 = analog input (evaporator probe) 2 = analog input (condenser probe)
P5	0	2	-	magnitude displayed during normal operation 0 = room temperature 1 = working setpoint 2 = if P4 = 0, "- -" if P4 = 1, evaporator temperature if P4 = 2, condenser temperature
P8	0	250	0,1s	delayed display of temperature changes as detected by the probes

LABEL	MIN.	MAS.	U.M.	MAIN REGULATOR
r0	0.1	15	°C/°F (1)	working setpoint differential; see also r12
r1	-99	r2	°C/°F (1)	minimum working setpoint
r2	r1	99	°C/°F (1)	maximum working setpoint
r4	0	99	°C/°F (1)	working setpoint increase during the "energy saving" function; see also i0, i10 and HE2
r5	0	1	-	cooling or heating operation (3) 0 = cooling 1 = heating
r12	0	1	-	working setpoint differential type 0 = asymmetric 1 = symmetric

LABEL	MIN.	MAS.	U.M.	COMPRESSOR PROTECTION SYSTEM
C0	0	240	min	delay in switching on of compressor after the device switches on (4)
C2	0	240	min	minimum compressor switch-off duration (5)
C3	0	240	s	minimum duration of compressor switch on time
C4	0	240	min	duration of compressor switch off time during a room temperature probe error (code "Pr1"); see also C5
C5	0	240	min	duration of compressor switch on time during a room temperature probe error (code "Pr1"); see also C4
C6	0	199	°C/°F (1)	condenser temperature is higher than that at which the condenser overheating alarm is activated (code "COH") (6)
C7	0	199	°C/°F (1)	condenser temperature above which the compressor shut down alarm is activated (code "CSd")
C8	0	15	min	compressor shut down alarm delay (code "CSd") (7)

LABEL	MIN.	MAS.	U.M.	DEFROST
d0	0	99	h	if d8 = 0, 1 or 2, defrost interval 0 = interval defrost will never be activated if d8 = 3, maximum defrost interval
d2	-99	99	°C/°F (1)	evaporator temperature at end of defrost; see also d3
d3	0	99	min	if P4 = 0 or 2, defrost duration if P4 = 1, maximum defrost duration; see also d2 0 = defrost will not be activated
d4	0	1	-	defrost when device is switched on (4) 1 = YES
d5	0	99	min	if d4 = 0, minimum time between switching on of device and activation of defrost (4) if d4 = 1, delay in activation of defrost after device is switched on (4)
d6	0	2	-	temperature displayed during defrost (only if P5 = 0) 0 = room temperature 1 = if on activation of defrost, the room temperature is below the "work setpoint + Δt", at maximum "work setpoint + Δt"; if on activation of defrost, the room temperature is above "work setpoint + Δt", at maximum the room temperature on activation of defrost (8) (9) 2 = label "dEF"
d7	0	15	min	dripping duration (during dripping the compressor will remain switched off)
d8	0	3	-	defrost activation methods 0 = AT INTERVALS - FOR TIME - defrost will be activated once the device has altogether been running for time d0 1 = AT INTERVALS - FOR COMPRESSOR SWITCH-ON - defrost will be activated once the compressor has altogether been switched on for time d0 2 = AT INTERVALS - FOR EVAPORATOR TEMPERATURE - defrost will be activated when the evaporator temperature has remained below the temperature d9 for a total time of d0 (10) 3 = ADAPTIVE - defrost will be activated at intervals, whose duration will each time depend on the duration of compressor switch-ons, the evaporator temperature and the door switch input activation; see also d18, d19, d20, d22, i13 and i14 (10)
d9	-99	99	°C/°F (1)	evaporator temperature is higher than that at which the defrost interval counter is suspended (only if d8 = 2)
d11	0	1	-	defrost alarm switches off once maximum time limit has been reached (code "dFd"); only if P4 = 1 and in absence of evaporator probe error (code "Pr2") 1 = YES
d16	0	999	min	defrost interval (defrost will be activated when the compressor has been on totally, with the evaporator temperature below that of d22, for time d18; only if d8 = 3) 0 = defrost will never be activated due to the effect of this condition
d18	0	999	min	defrost interval (defrost will be activated when the compressor has been on totally, with the evap. temp. below that of d22, for time d18; only if d8 = 3) 0 = defrost will never be activated due to the effect of this condition
d19	0	40	°C/°F (1)	evaporator temperature below which the defrost is activated (relative to the evaporator temperatures average, or "evaporator temperatures average - d19"; only if d8 = 3)
d20	0	999	min	minimum consecutive time the compressor must be switched on such as to provoke the defrost activation 0 = defrost will never be activated due to the effect of this condition
d22	0	19,9	°C/°F (1)	evaporator temperature above which the defrost interval count shall be suspended (relating to the average of evaporator temperatures, that is to say, "evaporator temperatures average + d22"; only if d8 = 3); see also d18

LABEL	MIN.	MAS.	U.M.	TEMPERATURE ALARMS (11) (12)
A1	0	99	°C/°F (1)	room temperature below which the minimum temperature alarm is triggered (code "AL"; it concerns the working setpoint, that is to say, "working setpoint - A1"); see also A11 0 = alarm absent
A4	0	99	°C/°F (1)	room temperature above which the maximum temperature alarm is triggered (code "AH"; it concerns the working setpoint, that is to say, "working setpoint + A4"); see also A11 0 = alarm absent
A6	0	99	10 min	delay in maximum temperature alarm (code "AH") after the device is switched on (4)
A7	0	199	min	minimum temperature alarm delay (code "AL") and maximum temperature alarm delay (code "AH")
A11	0,1	15	°C/°F (1)	differential of A1 and A4 parameters

LABEL	MIN.	MAS.	U.M.	DIGITAL INPUTS
i0	0	4	-	effect caused by the activation of the digital input 0 = no effect 1 = DOOR SWITCH - DOOR SWITCH INPUT ALARM ACTIVATION (code "id") - the compressor will be switched off (at maximum for time i3 or until the input is deactivated); see also i2 (13) 2 = MULTIFUNCTION - ACTIVATION OF "ENERGY SAVING" FUNCTION - the "energy saving" function will be activated (just with effect on the compressor, until the input is deactivated); see also r4 3 = MULTIFUNCTION - ACTIVATION OF MULTIFUNCTION INPUT ALARM (code "iA") - the device will continue to operate normally; see also i2 4 = MULTIFUNCTION - ACTIVATION OF THE MAXIMUM PRESSURE SWITCH ALARM (code "iA") - the compressor will be switched off (until the input is deactivated); see also i2
i1	0	1	-	type of digital input contact 0 = normally open (active input with closed contact) 1 = normally closed (active input with open contact)

i2	-1	120	min	if i0 = 1, delay in signalling of door switch input alarm (code "id") -1 = the alarm will not be signalled if i0 = 3, delay in signalling of multifunction input alarm (code "iA") -1 = the alarm will not be signalled if i0 = 4, delay in switching on of compressor after the deactivation of the maximum pressure switch alarm (code "IA") -1 = reserved
i3	-1	120	min	maximum duration of the effect caused by the activation of the door switch input on the compressor -1 = the effect will last until the input is deactivated
i10	0	999	min	time that must pass in absence of door switch input activations (after the room temperature has reached the working setpoint) for the "energy saving" function to be activated; see also r4 and HE2 0 = the function will never be activated due to the effect of this condition
i13	0	240	-	number of door switch input activations such as to provoke the defrost activation 0 = defrost will never be activated due to the effect of this condition
i14	0	240	min	minimum duration of the door switch input activation such as to provoke the defrost activation 0 = defrost will never be activated due to the effect of this condition

LABEL	MIN.	MAS.	U.M.	ENERGY SAVING
HE2	0	99	min	maximum duration of the "energy saving" function activated due to the effect of absence of door switch input activation; see also r4 and i10 0 = the function will last until the input is activated
HE3	0	240	min	time interval with no key strokes, after which the "low consumption" function is activated 0 = the mode shall never be aac

LABEL	MIN.	MAS.	U.M.	VARIOUS
POF	0	1	-	key activation 1 = YES
PAS	-99	999	-	access password for the configuration parameters 0 = the password need not be set

- (1) the unit of measurement depends on P2
- (2) properly set the parameters corresponding to the regulators after setting P2 parameter
- (3) if r5 parameter is set at 1, the "energy saving" function and the defrost management will be switched off
- (4) the parameter has effect even after an interruption in the power supply that occurs while the device is switched on
- (5) the time set by parameter C2 is counted also when the device is off
- (6) the differential of parameter is 2.0°C/4°F
- (7) if when the device is switched on, the condenser temperature is already above that established in C7 parameter, then C8 parameter will not have effect
- (8) the value Δt depends on r12 parameter (r0 if r12 = 0, r0/2 if r12 = 1)
- (9) the display restores normal operation when, at the end of the dripping phase, room temperature falls below the value that locked the display (or if a temperature alarm is triggered)
- (10) if P4 parameter is set at 0 or 2, the device will function as if d8 parameter were set at 0
- (11) during defrost and dripping, the maximum temperature alarm is absent, provided that it was triggered after defrost activation.
- (12) during activation of the door switch input, the maximum temperature alarm is absent, provided the alarm was signaled after the activation of the input
- (13) the compressor is switched off 10 s after the activation of the input

NORMALE TEMPERATUUR "-2/+10°C" "-2/+8°C" - LAGE TEMPERATUUR "-24/-12°C"

Setting the working setpoint

- Make sure that the keyboard is not locked and that no procedure is in progress
- Touch the **SET** key: the LED will flash
- Touch the or key within 15 s; see also r1 and r2 parameters
- Touch the **SET** key or do not operate for 15 s: the LED will switch off after which, the device will exit the procedure.

To exit the procedure before the operation is complete:

- Touch the (any changes will not be saved)

The working setpoint can also be set via **SP** parameter.

Working setpoints

LABEL	MIN.	MAS.	U.M.	WORKING SETPOINT
r1	r2		°C/°F	working setpoint; see also r0 and r12

Setting the configuration parameters

To access the procedure:

- Make sure no procedure is in progress
- Touch the **SET** key for 4 s: the display will show "PA"
- Touch the **SET**
- Touch the or key within 15 s to set the value determined with the "PAS" parameter (the parameter is set at "-19" by default)
- Touch the **SET** or do not operate for 15 s: the display will show "SP"

To select a parameter:

- Touch the or key

To set a parameter:

- Touch the **SET** key
- Touch the or key within 15 s.
- Touch the **SET** key or do not operate for 15 s.

To exit the procedure:

- Touch the **SET** key for 4 s or do not operate for 60 s (any changes will be saved)

Configuration parameters

LABEL	MIN.	MAS.	U.M.	WORKING SETPOINT
SP	r1	r2	°C/°F	working setpoint; see also r0 and r12

LABEL	MIN.	MAS.	U.M.	ANALOGUE INPUTS
CA1	-25	25	°C/°F	cabinet probe offset if P4 = 3, air in probe offset
CA2	-25	25	°C/°F	evaporator probe offset
CA3	-25	25	°C/°F	auxiliary probe offset
P0	0	1	-	probe type 0=PTC 1=NTC
P1	0	1	-	enable °C decimal point 0 = no 1 = yes
P2	0	1	-	temperature unit of measurement 0 = °C 1 = °F
P3	0	2	-	evaporator probe function 0 = disabled 1 = defrost + fan 2 = fan
P4	0	3	-	configurable input function 0 = digital input 1 = condenser probe 2 = critical temperature probe 3 = air out probe if P4 = 3, regulation temperature = product temperature (CPT)
P5	0	4	-	value displayed 0 = regulation temperature 1 = setpoint 2 = evaporator temperature 3 = auxiliary temperature 4 = air in temperature
P7	0	100	%	air in weight for calculated product temperature (CPT) CPT = $\{[(P7 \times (\text{air in})) + [(100 - P7) \times (\text{air out})]: 100]\}$
P8	0	250	0,1 s	display refresh time

LABEL	MIN.	MAS.	U.M.	REGULATION
r0	0.1	15	°C/°F	setpoint differential
r1	-99	r2	°C/°F	minimum setpoint
r2	r1	99	°C/°F	maximum setpoint
r4	0	99	°C/°F	setpoint offset in energy saving
r5	0	1	-	cooling or heating operation 0 = cooling 1 = heating
r6	0	99	°C/°F	setpoint offset in overcooling/overheating
r7	0	240	min	overcooling/overheating duration
r8	0	2	-	DOWN key additional function 0 = disabled 1 = overcooling/overheating 2 = energy saving
r12	0	1	-	position of the r0 differential 0 = asymmetric 1 = symmetric

LABEL	MIN.	MAS.	U.M.	COMPRESSOR
C0	0	240	min	compressor on delay after power-on
C2	0	240	min	compressor off minimum time
C3	0	240	s	compressor on minimum time
C4	0	240	min	compressor off time during cabinet probe alarm
C5	0	240	min	compressor on time during cabinet probe alarm
C6	0	200	°C/°F	threshold for high condensation warning
C7	0	200	°C/°F	threshold for high condensation alarm
C8	0	15	min	high condensation alarm delay
C10	0	9999	h	compressor hours for service 0 = disabled
C11	0	240	s	second compressor switch-on delay
C12	0	10	-	number of start-ups for compressor rotation 0 = disabled

LABEL	MIN.	MAS.	U.M.	DEFROST
d00	0	1	-	enable parameters type b 0 = no 1 = yes
d01	r1	r2	°C/°F	setpoint threshold to enable parameters type b if SP > d01
d0	0	99	h	automatic defrost interval 0 = only manual if d8 = 3, maximum interval
d0b	0	99	h	automatic defrost interval 0 = only manual

				if d8 = 3, maximum interval
d1	0	2	-	defrost type 0 = electric 1 = hot gas 2 = compressor stopped
d1b	0	2	-	defrost type 0 = electric 1 = hot gas 2 = compressor stopped
d2	-99	99	°C/°F	threshold for defrost end
d2b	-99	99	°C/°F	threshold for defrost end
d3	0	99	min	defrost duration if P3 = 1, maximum duration
d3b	0	99	min	defrost duration if P3 = 1, maximum duration
d4	0	1	-	enable defrost at power-on 0 = no 1 = yes
d5	0	99	min	defrost delay after power-on
d6	0	2	-	value displayed during defrost 0 = regulation temperature 1 = display locked 2 = dEF label
d7	0	15	min	dripping time
d7b	0	15	min	dripping time
d8	0	3	-	defrost interval counting mode 0 = device on hours 1 = compressor on hours 2 = hours evaporator temperature < d9 3 = adaptive 4 = real time
d9	-99	99	°C/°F	evaporation threshold for automatic defrost interval counting
d11	0	1	-	enable defrost timeout alarm 0 = no 1 = yes if d1 = 0 or 1, enabled with SP < 0, if d1 = 2, disabled
d15	0	99	min	compressor on consecutive time for hot gas defrost
d16	0	99	min	pre-dripping time for hot gas defrost
d18	0	999	min	adaptive defrost interval if compressor on + evaporator temperature < d22 0 = only manual
d19	0	40	°C/°F	threshold for adaptive defrost (relative to optimal evaporation temperature) optimal evaporation temperature - d19
d20	0	999	min	compressor on consecutive time for defrost 0 = disabled
d21	0	500	min	compressor on consecutive time for defrost after power-on and overcooling if (regulation temperature - setpoint) > 10°C/20 °F 0 = disabled
d22	0	10	°C/°F	evaporation threshold for adaptive defrost interval counting (relative to optimal evaporation temperature) optimal evaporation temperature + d22

LABEL	MIN.	MAS.	U.M.	ALARMS
AA	0	2	-	select value for high/low temperature alarms 0 = regulation temperature 1 = evaporator temperature 2 = auxiliary temperature
A1	0	99	°C/°F	threshold for low temperature alarm
A2	0	2	-	low temperature alarm type 0 = disabled 1 = relative to setpoint 2 = absolute
A4	0	99	°C/°F	threshold for high temperature alarm
A5	0	2	-	high temperature alarm type 0 = disabled 1 = relative to setpoint 2 = absolute
A6	0	99	10 min	high temperature alarm delay after power-on
A7	0	240	min	high/low temperature alarms delay
A8	0	240	min	high temperature alarm delay after defrost
A9	0	240	min	high temperature alarm delay after door closing
A10	0	240	min	power failure duration for alarm recording
A11	0,1	15	°C/°F	high/low temperature alarms reset differential

LABEL	MIN.	MAS.	U.M.	FANS
F0	0	4	-	evaporator fan mode during normal operation 0 = off 1 = on 2 = according to F15 and F16 if compressor off, on if compressor on 3 = thermoregulated (with F1 and F1A) 4 = thermoregulated (with F1 and F1A) if compressor on
F0b	0	4	-	evaporator fan mode during normal operation 0 = off 1 = on 2 = according to F15 and F16 if compressor off, on if compressor on 3 = thermoregulated (with F1 and F1A) 4 = thermoregulated (with F1 and F1A) if compressor on
F1	-99	99	°C/°F	threshold for evaporator fan off

F1A	-99	99	°C/°F	threshold for evaporator fan on if F1A > F1, F1 differential = 2 °C/4 °F
F2	0	2	-	evaporator fan mode during defrost and dripping 0 = off 1 = on 2 = according to F0
F2b	0	2	-	evaporator fan mode during defrost and dripping 0 = off 1 = on 2 = according to F0
F3	0	15	min	evaporator fan off maximum time
F3b	0	15	min	evaporator fan off maximum time
F4	0	240	10 s	evaporator fan off time during energy saving
F5	0	240	10 s	evaporator fan on time during energy saving
F7	-99	99	°C/°F	threshold for evaporator fan on after dripping (relative to setpoint) setpoint + F7
F9	0	240	s	evaporator fan off delay after compressor off
F10	0	99	°C/°F	difference "cabinet temperature - evaporator temperature" for evaporator fan on differential = 2 °C/4 °F
F11	0	99	°C/°F	threshold for condenser fan on
F12	0	240	s	condenser fan off delay after compressor off
F13	0	15	°C/°F	differential F11
F15	0	240	s	evaporator fan off time with compressor off if F0 = 2
F16	0	240	s	evaporator fan on time with compressor off if F0 = 2

LABEL	MIN.	MAS.	U.M.	DIGITAL INPUTS
i0	0	5	-	door switch input function 0 = disabled 1 = compressor + evaporator fan off 2 = evaporator fan off 3 = cabinet light on 4 = compressor + evaporator fan off, cabinet light on 5 = evaporator fan off + cabinet light on
i1	0	1	-	door switch input activation 0 = with contact closed 1 = with contact open
i2	-1	120	min	open door alarm delay -1 = disabled
i3	-1	120	min	regulation inhibition maximum time with door open -1 = until the closing
i5	0	7	-	door switch/multi-purpose input function 0 = disabled 1 = energy saving 2 = iA alarm 3 = button-operated load on 4 = device on/off 5 = Cth alarm 6 = th alarm 7 = compressor + evaporator fan off, cabinet light on 8 = evaporator fan off + cabinet light on
i6	0	1	-	door switch/multi-purpose input activation 0 = with contact closed 1 = with contact open
i7	0	120	min	multi-purpose input alarm delay -1 = disabled if i5 = 5 or 6, compressor on delay after alarm reset
i10	0	999	min	door closed consecutive time for energy saving after regulation temperature < SP 0 = disabled
i13	0	240	-	number of door openings for defrost 0 = disabled
i14	0	240	min	door open consecutive time for defrost 0 = disabled

LABEL	MIN.	MAS.	U.M.	DIGITAL OUTPUTS
uc1	0	12	-	relay K1 configuration 0 = compressor 1 = defrost 2 = evaporator fan 3 = cabinet light 4 = demisting 5 = button-operated load 6 = alarm 7 = door heaters 8 = heater for neutral zone 9 = condenser fan 10 = on/stand-by 11 = compressor 2 12 = disabled
uc2	0	12	-	relay K2 configuration (like uc1)
uc3	0	12	-	relay K3 configuration (like uc2)
uc4	0	12	-	relay K4 configuration (like uc3)
u2	0	1	-	enable cabinet light and buttonoperated load in stand-by 0 = no

				1 = yes manual
u4	0	1	-	enable alarm output off silencing the buzzer 0 = no 1 = yes
u5	-99	99	°C/°F	threshold for door heaters on differential = 2 °C/4 °F
u6	0	120	min	demisting on duration 0 = manual
u7	-99	99	°C/°F	neutral zone threshold for heating (relative to setpoint) setpoint + u7
u8	1	15	°C/°F	u7 differential

LABEL	MIN.	MAS.	U.M.	ENERGY SAVING (if r5 = 0)
HE2	0	999	min	energy saving maximum duration -1 = until the door opening

LABEL	MIN.	MAS.	U.M.	REAL TIME ENERGY SAVING (if r5 = 0)
H01	0	23	h	Daily energy saving time
H02	0	24		Daily energy saving maximum duration

LABEL	MIN.	MAS.	U.M.	REAL TIME DEFROST (if d8 = 4)
Hd1	-	-	-	1st daily defrost time h= disabled
Hd2	-	-	-	2st daily defrost time h= disabled
Hd3	-	-	-	3st daily defrost time h= disabled
Hd4	-	-	-	4st daily defrost time h= disabled
Hd5	-	-	-	5st daily defrost time h= disabled
Hd6	-	-	-	6st daily defrost time h= disabled

LABEL	MIN.	MAS.	U.M.	SAFETIES
Pbu	0	2	-	selecting the event for buzzer activation 0 = disabled 1 = alarms 2 = keys and alarms
POF	0	1	-	enable ON/STAND-BY key 0 = no 1 = yes
PAS	-99	999	-	password
PA1	-99	999	-	level 1 password
PA2	-99	999	-	level 2 password

LABEL	MIN.	MAS.	U.M.	REAL TIME CLOCK
POF	0	1	-	enable clock 0 = no 1 = yes

LABEL	MIN.	MAS.	U.M.	DATA-LOGGING EVLINK
bLE	0	99	-	enable Bluetooth 0 = free 1 = forced for EVconnect or EPoCA 2... 99 = EPoCA local network address
rE0	0	240	min	data-logger sampling interval
rE1	0	5	-	recorded temperature 0 = none 1 = cabinet 2 = evaporator 3 = auxiliary 4 = cabinet and evaporator 5 = all

LABEL	MIN.	MAS.	U.M.	MODBUS
LA	1	247	-	MODBUS address
Lb	0	3	-	MODBUS baud rate 0 = 2,400 baud 1 = 4,800 baud 2 = 9,600 baud 3 = 19,200 baud parity even

VOCHTIGHEIDSMANAGEMENT' (uitsluitend op apparaten Pastry & Bakery)





Het is mogelijk de vochtigheidswaarde in te stellen afhankelijk van de te conserveren voeding:

- zorg ervoor dat het toetsenbord niet is vergrendeld en dat er geen procedure wordt uitgevoerd
- houd de knop **FNC** 2 s ingedrukt: op het display verschijnt het label met betrekking tot de vochtigheidsinstelling (**rH⁺** = hoge vochtigheid of **rH-** = lage vochtigheid)
- houd de knop **SET** 2 s ingedrukt om de instelling te wijzigen
- druk op de  om de procedure te bevestigen en af te sluiten.

ALARMSIGNALEN

NORMALE TEMPERATUUR "0/+10°C" "+2/+10°C"

Signals

LED	MEANING
	Compressor LED If the LED is on, the compressor is on If the LED is flashing: - the working setpoint is in the process of being set - a compressor protection will be in progress
	Defrost LED If the LED is on, defrost is in progress If the LED is flashing, dripping will be in progress
	Energy saving LED If the LED is on and the display is switched on, the "energy saving" function is in progress If the LED is on and the display is switched off, the "low consumption" function is in progress; touch a key to restore normal display
°C	Celsius degrees LED If the LED is on, the unit of measurement for temperature is Celsius degrees
°F	Fahrenheit degrees LED If the LED is on, the unit of measurement for temperature is Fahrenheit degrees
	LED on/stand-by If the LED is on, the device is switched off

Signals

CODE	MEANING
Loc	the keyboard is blocked
- - -	the operation requested is not available
dEF	defrost is in progress

Alarms

CODE	MEANING
AL	Minimum temperature alarm Solutions: - check the room temperature; see A1 parameter Main consequences: - the device will continue to operate normally
AH	Maximum temperature alarm Solutions: - check the room temperature; see A4 parameter Main consequences: - the device will continue to operate normally
id	Door switch input alarm Solutions: - check the causes of the activation of the input; see i0 and i1 parameters Main consequences: - the effect established with the i0 parameter
dFd	Defrost alarm switched off because maximum time has been reached Solutions:

	<ul style="list-style-type: none"> - check the integrity of the evaporator probe; see d2, d3 and d11 parameters - touch a key to restore normal display <p>Main consequences:</p> <ul style="list-style-type: none"> - the device will continue to operate normally
--	--

When the cause of the alarm disappears, the device restores normal operation, except for the following alarms:

- compressor shut down alarm (code "CSd") which requires the switching off of the device or the temporary suspension of the power supply.
- defrost alarm switched off because maximum time has been reached (code "dFd") which requires the touching of a key







Errors

CODE	MEANING
Pr1	<p>Room temperature probe error</p> <p>Solutions:</p> <ul style="list-style-type: none"> - check that the probe is the PTC or NTC type; see P0 parameter - check the device-probe connection - check room temperature <p>Main consequences:</p> <ul style="list-style-type: none"> - compressor activity will depend on C4 and C5 parameters - the defrost will not be activated
Pr2	<p>Evaporator probe or condenser probe error</p> <p>Solutions:</p> <ul style="list-style-type: none"> - the same as in the previous example, but with regard to the evaporator probe or the condenser probe <p>Main consequences:</p> <ul style="list-style-type: none"> - if P4 parameter is set at 1, the defrost interval will last for the amount of time set with d3 parameter - if P4 parameter is set at 1 and d8 parameter is set at 2 or to 3, the device will operate as if d8 parameter were set at 0 - if P4 parameter is set at 2, the condenser overheated alarm (code "COH") will never be activated - if P4 parameter is set at 2, the compressor shut down alarm (code "CSd") will never be activated

When the cause of the error disappears, the device restores normal operation.

NORMALE TEMPERATUUR "-2/+10°C" "-2/+8°C" - LAGE TEMPERATUUR "-24/-12°C"
--

Signals

LED	MEANING
	<p>Compressor LED</p> <ul style="list-style-type: none"> - If the LED is on, the compressor is on - If the LED is flashing: <ul style="list-style-type: none"> - the working setpoint is in the process of being set - a compressor protection will be in progress
	<p>Defrost LED</p> <ul style="list-style-type: none"> - If the LED is on, defrost is in progress - pre-dripping is in progress - If the LED is flashing: <ul style="list-style-type: none"> - defrost will be requested but a compressor protection will be in progress - dripping will be in progress - defrost will be requested but a compressor minimum switch-on shall be in progress
	<p>Evaporator fan LED</p> <ul style="list-style-type: none"> - If the LED is on the evaporator fan will be on - If the LED is flashing evaporator fan standstill will be in progress
HACCP	<p>Saved HACCP alarm in EVlink</p>
AUX	<p>Auxiliary LED</p> <ul style="list-style-type: none"> - If the LED is on: <ul style="list-style-type: none"> - the door resistances will be lit
	<p>Energy saving LED</p> <ul style="list-style-type: none"> - If the LED is on and the display is switched on, the "energy saving" function is in progress - If the LED is on and the display is switched off, the "low consumption" function is in progress; touch a key to restore normal display
	<p>Maintenance LED</p> <ul style="list-style-type: none"> - if it is on, the compressor must be maintained
°C	<p>Celsius degrees LED</p> <ul style="list-style-type: none"> - If the LED is on, the unit of measurement for temperature is Celsius degrees - If it is flashing, the "rapid cooling" or "rapid heating" function will be in progress
°F	<p>Fahrenheit degrees LED</p> <ul style="list-style-type: none"> - If the LED is on, the unit of measurement for temperature is Fahrenheit degrees - If it is flashing, the "rapid cooling" or "rapid heating" function will be in progress
	<p>LED on/stand-by</p> <ul style="list-style-type: none"> - If the LED is on, the device is switched off ("standby" status)

Signals

CODE	MEANING
Loc	the keyboard is blocked
- - -	the operation requested is not available

Alarms

CODE	MEANING
rtc	Clock alarm Solutions: set date, time and day of the week
AL	Minimum temperature alarm in the compartment Solutions: - check the room temperature or CPT temperature; see A1 parameter Main consequences: - the alarm output will be switched on
AH	Maximum temperature alarm in the compartment Solutions: - check the room temperature or CPT temperature; see A4 parameter Main consequences: - the alarm output will be switched on
id	Door switch input alarm Solutions: - check the causes of the activation of the input; see i0 and i1 parameters Main consequences: - the effect established with the i0 parameter - the alarm output will be switched on
PF	Power failure alarm Solutions: - touch a key - check electrical connection
dFd	Defrost alarm switched off because maximum time has been reached Solutions: - check the integrity of the evaporator probe; see d2, d3 and d11 parameters - touch a key to restore normal display Main consequences: - the device will continue to operate normally

When the cause of the alarm disappears, the device restores normal operation, except for the following alarms:

- the compressor blocked alarm (code "CSd") and the global thermal protection alarm (code "th"), which both need to be reset by turning the device off or switching off the power supply.
- defrost alarm switched off because maximum time has been reached (code "dFd") which requires the touching of a key.

Errors

CODE	MEANING
Pr1	Room temperature probe or inlet air probe error Solutions: - check that the probe is the PTC or NTC type; see P0 parameter - check the device-probe connection - check room temperature/CPT temperature Main consequences: - compressor activity will depend on C4 and C5 parameters - if the P4 parameter is set at 3, the temperature associated with the regulation and the temperature alarms shall be the outgoing air temperature - the defrost will not be activated - the alarm output will be switched on - the door heating elements shall be turned off - the neutral area operation heating elements will be turned off
Pr2	Evaporator/defrost probe error Solutions: - the same as in the previous example, but with regard to the evaporator probe Main consequences: - if P3 parameter is set at 1, the defrost interval will last for the amount of time set with d3 parameter - if P3 parameter is set at 1 and d8 parameter is set at 2 or to 3, the device will operate as if d8 parameter were set at 0 - if P3 parameter is set at 1 or 2 and F0 parameter is set at 3 to 4, the device will operate as if parameter were set at 2 - the alarm output will be switched on

When the cause of the error disappears, the device restores normal operation.

ONTDOOIEN

AUTOMATISCHE ONTDOOIING VAN DE KOELKASTEN.

Ontdooiing op lucht van de "NORMALE TEMPERATUUR 0/+10°C ÷ +2/+10°C" installaties vindt iedere 6 uur automatisch plaats. Het ontdooiingsproces duurt 20 min.

Het ontdooien van het apparaat "NORMALE TEMPERATUUR -2/+10°C ÷ -2/+8°C" gebeurt d.m.v. weerstand en vindt automatisch iedere zes uur plaats. De duur van de ontdooiingscyclus wordt door het apparaat geregeld.

Het ontdooien van het apparaat "LAGE TEMPERATUUR -24/-12°C" is op heet gas en vindt automatisch iedere zes uur gebruikt van de compressor. De duur van de ontdooiingscyclus wordt door het apparaat geregeld.

Het is ieder geval mogelijk op ieder moment een ontdooiingscyclus te starten door gedurende 5 seconden op de drukknop "▲❄"; te drukken: de automatische ontdooiing gaat in na 6 uur voor installaties bij "NORMALE TEMPERATUUR" en zes uur gebruikt van de compressor voor installaties bij "LAGE TEMPERATUUR".

INLEGGEN VAN PRODUCTEN

- Verdeel het product op gelijke wijze in de koelruimten teneinde een goede luchtcirculatie te bewerkstelligen;
- Vermijd het afsluiten van de ventilatiezones van de koelingsinstallatie aan de linkerkant van de ruimte;
- Plaats geen levensmiddelen die op lage temperatuur bewaard dienen te worden, in de laatste lade rechtsonder;
- Levensmiddelen afdekken of inwickelen met de daarvoor bedoelde beschermfolie alvorens deze in de koelkast te plaatsen;
- Geen te warme eet- of drinkwaar in de koelkast plaatsen;
- De deuren niet langer dan nodig open laten tijdens het eruit halen of erin plaatsen van levensmiddelen;
- Leg de producten op het bovenste rooster slechts tot aan de stapelgrens;
- Geen producten onder het onderste schap.
- *Modellen Snack*: bij het laden van de onderste laden mag de belastingslimiet niet worden overschreden.

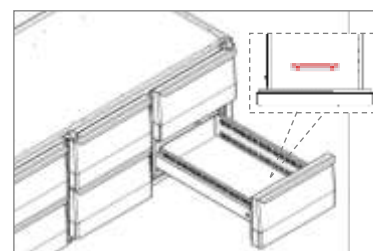
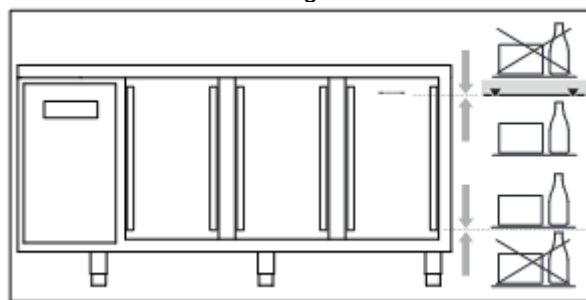

UITZETTEN

In iedere omstandigheid is het voldoende om het apparaat uit te zetten de hoofdschakelaar 1 op OFF te zetten.

OPGELET: De hoofdschakelaar 1 haalt het apparaat niet van het net af.

De hoofdschakelaar op OFF zetten.

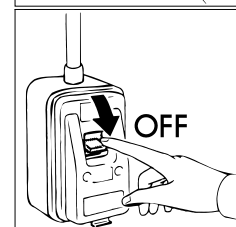
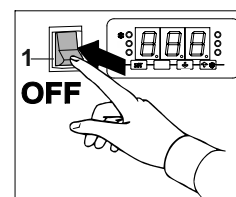

Om het apparaat van het lichtnet af te halen dient men de stekker uit het stopcontact te halen.

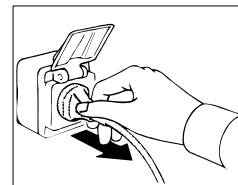

ONREGELMATIGHEDEN IN DE WERKING

In geval van onregelmatige functionering moet men, alvorens de servicedienst van de zone te raadplegen, controleren of:

- of de hoofdschakelaar brandt, en of er netspanning is;
- de ingestelde temperatuurwaarde de gewenste is;
- de deuren goed gesloten zijn;
- het apparaat niet dicht bij warmtebronnen geplaatst is;
- de condensator schoon is en de ventilator regelmatig werkt;
- er geen overvloedige ijsvorming op de verdampingsplaat bestaat.

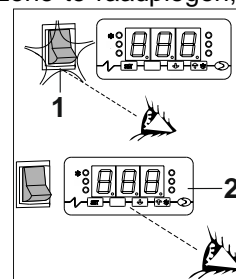

In geval genoemde controles negatief resultaat opgeleverd hebben, zich tot de servicedienst van de zone wenden onder vermelding van de op het kenmerkenplaatje weergegeven gegevens van het model en het registratienummer.

GEBRUIKSONDERBREKINGEN

In geval van langdurige stilstand van het apparaat als volgt te werk gaan:

- de schakelaar op het bedieningsdashbord op stand OFF zetten;
- de netschakelaar op stand OFF zetten;
- de stekker van het voedingssnoer uit het stopcontact halen en wachten tot het apparaat volledig ontdooid is;
- Het basiselement legen en dit schoonmaken, zoals beschreven is in het hoofdstuk "REINIGING".
- De deuren en de laden van het apparaat op een kier laten staan, om de vorming van stank te vermijden.

STORINGEN IN DE WERKING

Vaak zijn de storingen die eventueel in de werking op kunnen treden te wijten aan kleine oorzaken die u meestal zelf kunt verhelpen. Dus verricht voordat u de technische dienst inschakelt eerst de volgende eenvoudige controles:

PROBLEEM	MOGELIJKE OORZAKEN
Het apparaat gaat niet aan	Controleer of de stekker goed in het stopcontact zit
	Controleer of er stroom naar het stopcontact gevoerd wordt
De binnentemperatuur is te hoog	Controleer de regeling van de thermostaat
	Ga na dat er geen warmtebron in de buurt is waardoor het apparaat beïnvloed wordt
	Controleer of de deur goed sluit
Het apparaat maakt abnormaal veel lawaai	Controleer of het apparaat vlak staat, als het apparaat niet in balans staat dan kunnen hierdoor dit namelijk trillingen teweeggebracht worden
	Controleer of het apparaat niet in aanraking is met andere apparaten of delen die kunnen gaan resoneren
Onaangename geuren in de koelkast	In de koelkast bevinden zich niet goed verpakte levensmiddelen met een sterke geur (bijvoorbeeld kaas of meloen)
	De binnenkant moet gereinigd worden
Condensvorming op de apparatuur	Hoge luchtvochtigheidsgraad
	De koelkastdeuren zijn niet goed gesloten

Als u na deze controles verricht te hebben constateert dat de storing voortduurt dan moet u zich tot de technische dienst wenden en het volgende melden:

- de aard van de storing
- het model en het serienummer van het apparaat, deze gegevens kunt u van het typeplaatje afleiden, dat onder het bedieningspaneel van het apparaat aangebracht is.

SPECIFICATIES VAN DE KOELVLOEISTOF

R290

GWP = 3

ODP = 0

❖ Identificatie van de gevaren

Vloeibaar gas - Zeer licht ontvlambaar

❖ Eerste hulp maatregelen

• Inhalatie:

kan tot verstikking leiden bij hoge concentraties. Mogelijke symptomen zijn verlamming en/of verlies van bewustzijn. Slachtoffers zijn zich mogelijk niet bewust van eventuele verstikking. Kan een verdovende werking hebben in lage concentraties. Mogelijke symptomen zijn duizeligheid, hoofdpijn, misselijkheid en verlies van coördinatie. Verplaats het slachtoffer naar een onbesmette ruimte met toepassing van beademingsapparatuur. Houd de patiënt warm en in liggende positie. Raadpleeg een arts. Pas kunstmatige beademing toe als de ademhaling stopt.

• Contact met huid en ogen:

in geval van lekkage, reinig de ogen grondig met water gedurende minstens 15 minuten

• Inslikken:

onwaarschijnlijke wijze van blootstelling

❖ Milieu-informatie

er is geen milieuschade bekend die dit product kan veroorzaken

BESCHRIJVING ELEKTRISCH SCHEMA

Op de laatste pagina van de handleiding is het elektrische bedradingschema aangegeven.

Pos	BESCHRIJVING	Pos	BESCHRIJVING
1	COMPRESSOR	20C	ANTI-CONDENSWEERSTAND DEUREN
2	VENTILATOR CONDENSATOR	21	ONTDOOIINGSWEERSTAND
3	KLEMMENBORD	22	WEERSTAND BODEM BAKJE
6	HOOFDSCHAKELAAR	44	ENERGIERELAIS
8	ELECTRISCHE STEKKER	69	AARDKLEM
9	VENTILATOR VERDAMPER	75	ELEKTROKLEP
12	ELEKTRISCHE ONTODIKLEP	88	THERMOREGELAAR DGT
20	ANTI-CONDENSWEERSTAND DEUREN	90	THERMOREGELAAR DGT
20A	ANTI-CONDENSWEERSTAND DEUREN	102	VEILIGHEIDSTHERMOSTAAT
20B	ANTI-CONDENSWEERSTAND DEUREN		

СОДЕРЖАНИЕ

ТЕХНИКА БЕЗОПАСНОСТИ.....	2
ПРАВИЛА ТЕХНИКИ БЕЗОПАСНОСТИ	2
МЕХАНИЧЕСКОЕ ОПИСАНИЕ	4
ИДЕНТИФИКАЦИОННАЯ ЭТИКЕТКА.....	4
ГАБАРИТНЫЕ РАЗМЕРЫ	5
УСТАНОВКА И ЗАПУСК	7
ГЕНЕРАЛЬНАЯ ЧИСТКА И ЕЖЕДНЕВНЫЙ УХОД	8
ОБСЛУЖИВАНИЕ ШКАФЫ ИЗ НЕРЖАВЕЮЩЕЙ СТАЛИ.....	8
ОБСЛУЖИВАНИЕ ШКАФЫ VX-РЕТ	10
ВЫБРОС ОТХОДОВ И ИХ РАЗМЕЩЕНИЕ	10
ОБЩИЕ ЗАМЕЧАНИЯ ПО ПОСТАВКЕ	11
ДОПОЛНЕНИЯ.....	11
ИНСТРУКЦИИ ПО САМОКОНТРОЛЮ ОБОРУДОВАНИЯ.....	11
ТЕХНИЧЕСКИЕ ХАРАКТЕРИСТИКИ.....	12
ПАНЕЛИ УПРАВЛЕНИЯ.....	13
ЗАПУСК И ЭКСПЛУАТАЦИЯ	13
БЛОКИРОВАНИЕ/РАЗБЛОКИРОВАНИЕ КЛАВИАТУРЫ	13
НАСТРОЙКА РАБОТЫ И КОНФИГУРАЦИЯ ПАРАМЕТРОВ	13
УПРАВЛЕНИЕ ВЛАЖНОСТЬЮ (<i>только для аппаратов Pastry & Bakery</i>).....	20
СИГНАЛИЗАЦИИ.....	21
РАЗМОРАЖИВАНИЕ	23
ЗАГРУЗКА ПРОДУКТА.....	24
ОСТАНОВКА.....	24
ВОЗМОЖНЫЕ ПОЛОМКИ ПРИ ЭКСПЛУАТАЦИИ.....	25
ПЕРЕРЫВ В ИСПОЛЬЗОВАНИИ.....	25
ПРОБЛЕМЫ ФУНКЦИОНИРОВАНИЯ	25
ТЕХНИЧЕСКАЯ СХЕМА РЕФРИЖЕРАТОРА	26
ЭЛЕКТРИЧЕСКАЯ СХЕМА	26

ТЕХНИКА БЕЗОПАСНОСТИ

ПРЕДУПРЕЖДЕНИЕ: Этот шкаф содержит углеводородный хладагент (R290).

ОПАСНО: Риск возгорания и взрыва. В агрегате содержится легковоспламеняющийся хладагент. Запрещается применять механические средства для очистки холодильного агрегата ото льда. Не допускать сквозных повреждений трубопровода с хладагентом!

ОПАСНО: Риск возгорания и взрыва. В агрегате содержится легковоспламеняющийся хладагент. Ремонт производится только квалифицированным техническим персоналом. Не допускать сквозных повреждений трубопровода с хладагентом!

ОСТОРОЖНО: Риск возгорания и взрыва. В агрегате содержится легковоспламеняющийся хладагент. Перед началом технического обслуживания оборудования ознакомиться с руководством пользователя. Необходимо соблюдать все меры предосторожности.

ОСТОРОЖНО: Риск возгорания и взрыва. При утилизации соблюдать федеральные и местные нормы и правила. В агрегате содержится легковоспламеняющийся хладагент.

ОСТОРОЖНО: При образовании отверстия в трубопроводе с хладагентом возникает риск возгорания и взрыва. Тщательно соблюдать указания по обращению с оборудованием. В агрегате содержится легковоспламеняющийся хладагент.

ОСТОРОЖНО: Не загромождать вентиляционные отверстия в корпусе агрегата и в конструкции, в которую он встроен.

ОСТОРОЖНО: не хранить взрывчатые вещества, такие как аэрозольные баллоны с горючим пропеллентом, внутри аппарата.



Предупреждающий знак горючести ввиду присутствия горючего хладагента (R290)

Инструкции доступны на сайте www.sagispa.it.

ПРАВИЛА ТЕХНИКИ БЕЗОПАСНОСТИ

Устройства оснащены шнуром питания с вилкой.

ВНИМАНИЕ: перед началом любой операции или чистки необходимо изолировать аппаратуру от электроэнергии:

– поставить генеральный выключатель в позицию OFF.

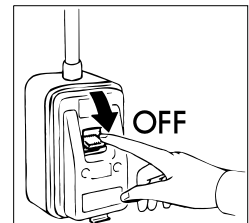

– вынуть из розетки шнур питания. Извлечение вилки должно быть таким, чтобы оператор мог видеть ее отсоединение с каждой рабочей точки.

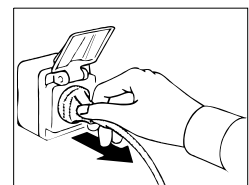

ВНИМАНИЕ: не использовать розетки и вилки без заземления.

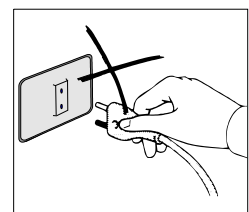

Розетка сети питания должна иметь **ЗАЗЕМЛЕНИЕ**.

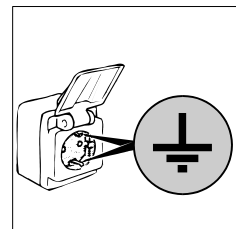

ВНИМАНИЕ: не пользоваться для соединения удлинителями и тройниками.

ВНИМАНИЕ: если кабель питания поврежден, центр обслуживания или валифицированный персонал обязан его заменить.

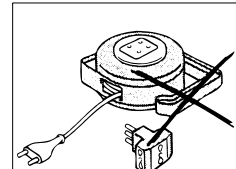

Чистка и ремонт рефрижераторного устройства и зоны компрессоров требует вмешательства квалифицированного и уполномоченного техника, поэтому не может осуществляться неквалифицированным персоналом.



В случае поломки или аномалий отключить полностью аппарат из сети; потребовать вмешательства **ТЕХОБСЛУЖИВАНИЯ** авторизованного центра или центра подлинных запчастей.

Неисполнение вышеперечисленных правил может привести к нарушению безопасной работы аппаратов.

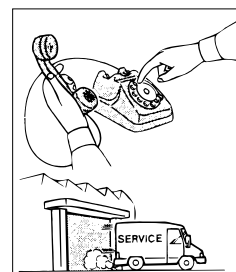

ВНИМАНИЕ: перед помещением пищевых продуктов для хранения подождать необходимо время понижения температуры до указанного уровня.

Всегда покрывать продукты специальной пленкой перед помещением их в холодильник.

ВНИМАНИЕ: Не помещать внутрь аппарата горячую пищу и напитки.

ВНИМАНИЕ: не проводить уборку рядом с аппаратом, если его дверца открыта.

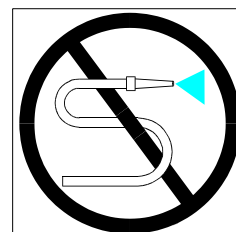

Не мыть аппаратуру проточной водой под напором.

ВНИМАНИЕ: не использовать хлорсодержащие (отбеливатель, соляная кислота и т.д.) и токсичные вещества для чистки аппаратов или вблизи них.

ВНИМАНИЕ: не используйте механические устройства или другие средства для ускорения процесса размораживания кроме тех, которые рекомендованы производителем.

ВНИМАНИЕ: не используйте электроприборы внутри отсеков.

Оборудование спроектировано с уровнем звукового давления ниже 70 дБ (А)



МЕХАНИЧЕСКОЕ ОПИСАНИЕ

Эта аппаратура создана для охлаждения и хранения пищевых продуктов. Любое другое использование считается неподходящим.

ВНИМАНИЕ: машины не предназначены для установления их на открытом месте или на подвергающихся атмосферным воздействиям пространствах.

Конструктор снимает с себя любую ответственность в случае использования аппаратуры в других целях.

Как основа, они имеют в верхней части поверхность для работы, в наличии имеются даже с задним бортиком, также в наличии имеются рефрижераторы и без поверхности для работы с аналогичной охлаждающей способностью.

Команды имеют цифровой терморегулятор, распределитель двойной влажности и общий выключатель.

Группа моторов находится с левой стороны основы в специальном углублении.

Испаритель расположен внутри рефрижератора, каждый в своём проёме и защищён специальной решёткой.

Внутренняя вентиляция осуществляется тригонометричными защищёнными вентиляторами, расположенными над испарителем.

Приспособление оснащено автоматическим испарителем конденсации.

Зоны, находящиеся в контакте с пищевыми продуктами выполнены из стали или облицованы нетоксичными материалами.

Складировать в не пыльном, сухом месте с достаточной вентиляцией при температуре от -20°C до +50°C и относительной влажности от 30% до 80%.

ИДЕНТИФИКАЦИОННАЯ ЭТИКЕТКА

Агрегаты всегда имеют идентификационную табличку, которая даёт ряд важных технических сведений о приборах и их конструктивных характеристиках.

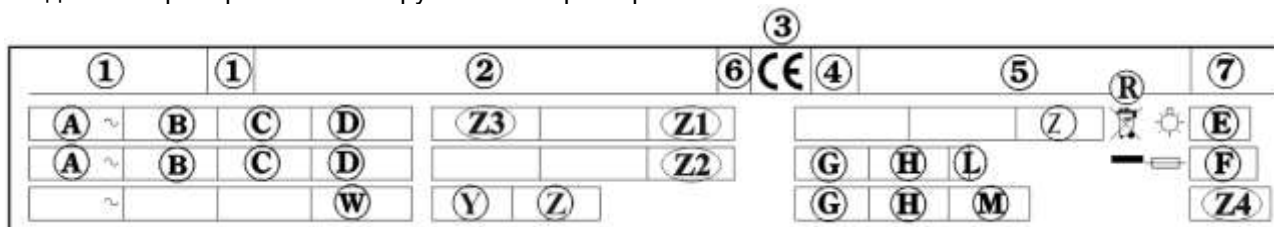

СОДЕРЖАНИЕ ТЕХНИЧЕСКОЙ ТАБЛИЧКИ

- | | |
|--------------------------------------|---------------------------------------|
| 1) МОДЕЛЬ | F) ТОК КОРОТКОГО ЗАМЫКАНИЯ |
| 2) ЗАВОД-ИЗГОТОВИТЕЛЬ И АДРЕС | G) ТИП ОХЛАЖДАЮЩЕЙ ЖИДКОСТИ |
| 3) АББРЕВИАТУРА МАРКИРОВКИ CE | H) КОЛИЧЕСТВО ОХЛАЖДАЮЩЕЙ ЖИДКОСТИ |
| 4) ГОД ИЗГОТОВЛЕНИЯ | L) КЛАСС ТЕМПЕРАТУРЫ |
| 5) НОМЕР ПАСПОРТА | R) СИМВОЛ ОЭЭО |
| 6) КЛАСС ЭЛЕКТРОЗАЩИТЫ | W) МОЩНОСТЬ ОБОГРЕВАТЕЛЬНЫХ ЭЛЕМЕНТОВ |
| A) НАПРЯЖЕНИЕ ЭЛЕКТРОПИТАНИЯ | Z1) ПОЛЕЗНЫЙ ОБЪЕМ (RSV) |
| B) ИНТЕНСИВНОСТЬ ЭЛЕКТРИЧЕСКОГО ТОКА | Z2) FLUID FOAMING |
| C) ЧАСТОТА | Z3) РАБОЧАЯ ТЕМПЕРАТУРА |
| D) ПОТРЕБЛЯЕМАЯ МОЩНОСТЬ | Z4) GWP |
| E) ОБЩАЯ МОЩНОСТЬ ЛАМП | |

Климатический класс*	Температура окружающей среды
3 (SN)	+10°C ---> +32°C
4 (N)	+16°C ---> +32°C
4+ (ST)	+16°C ---> +38°C
4+ (SN-ST)	+10°C ---> +38°C
5 (T)	+16°C ---> +43°C
5 (SN-T)	+10°C ---> +43°C

(*) Температурный климатический класс указывает температуру окружающей среды, при которой оборудование может работать.

ГАБАРИТНЫЕ РАЗМЕРЫ

Сверьте размеры Вашего аппарата.

- Модель глубины 600

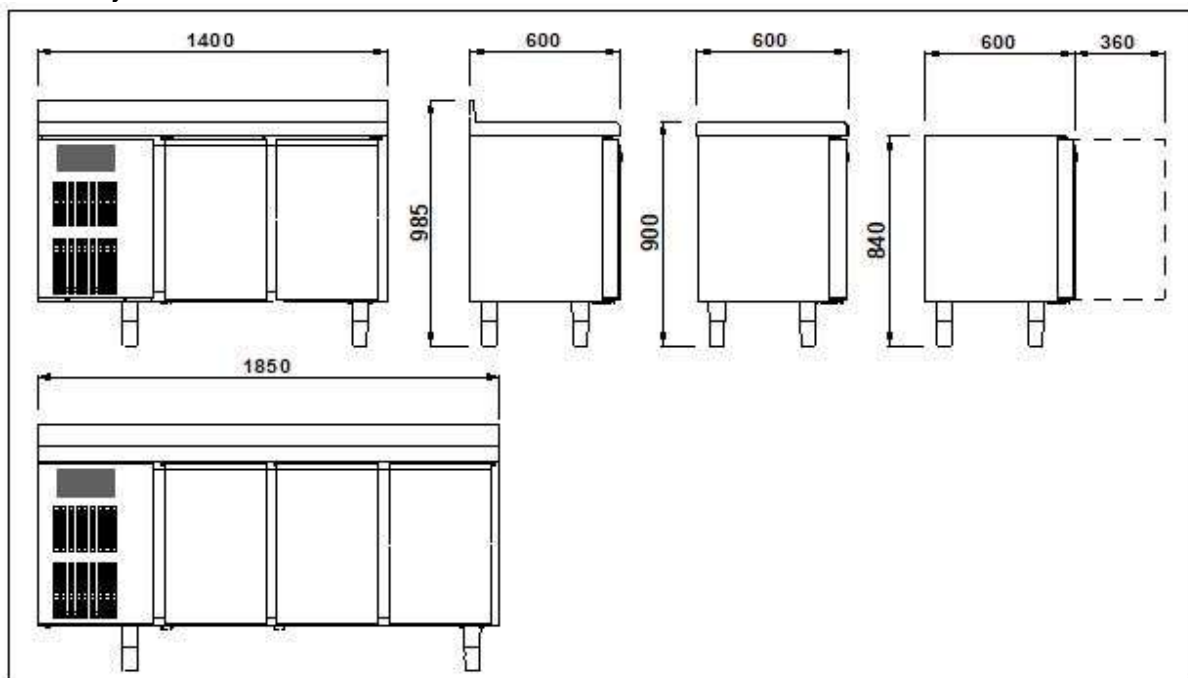

- Модель глубины 700

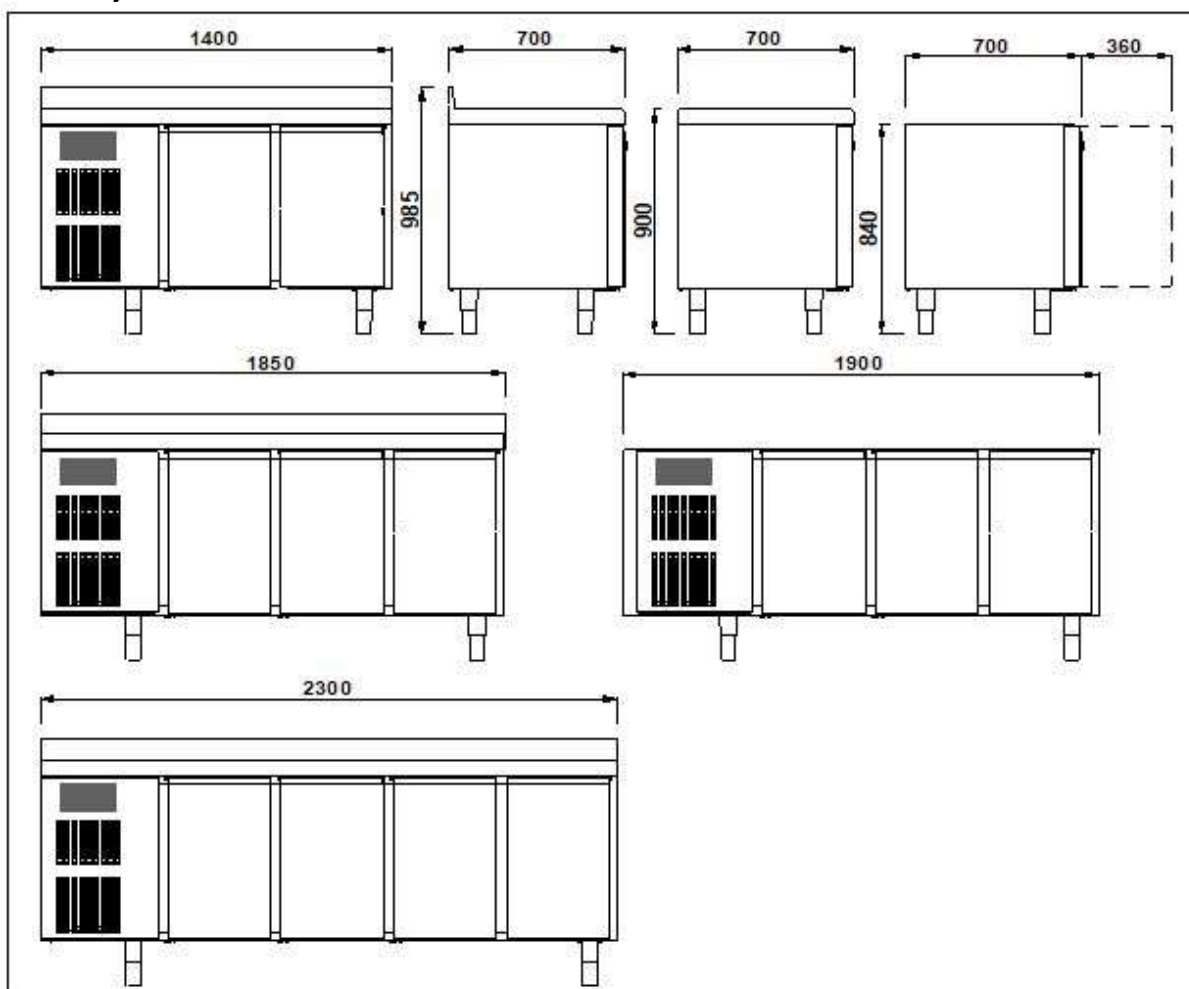

- Модель *snack*

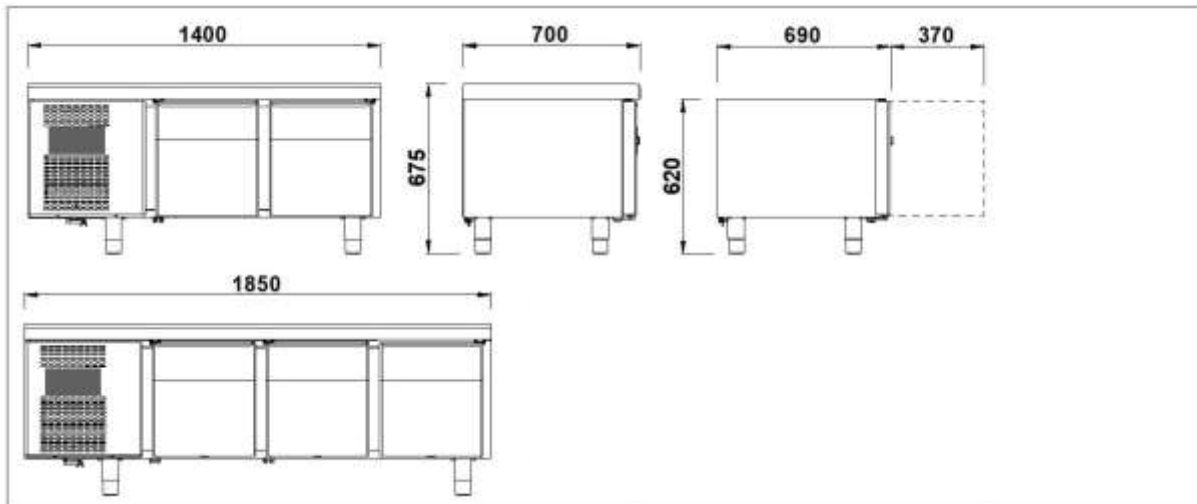

- Модель *pastry & bakery*

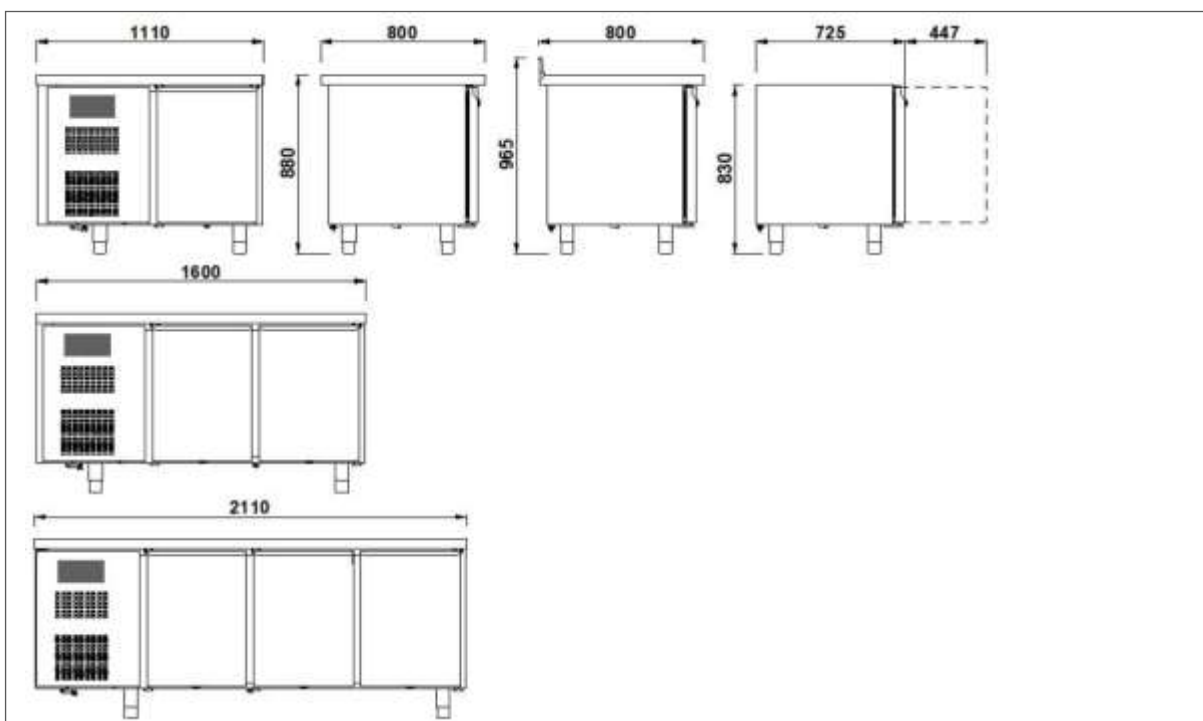

- Модель *pizza*

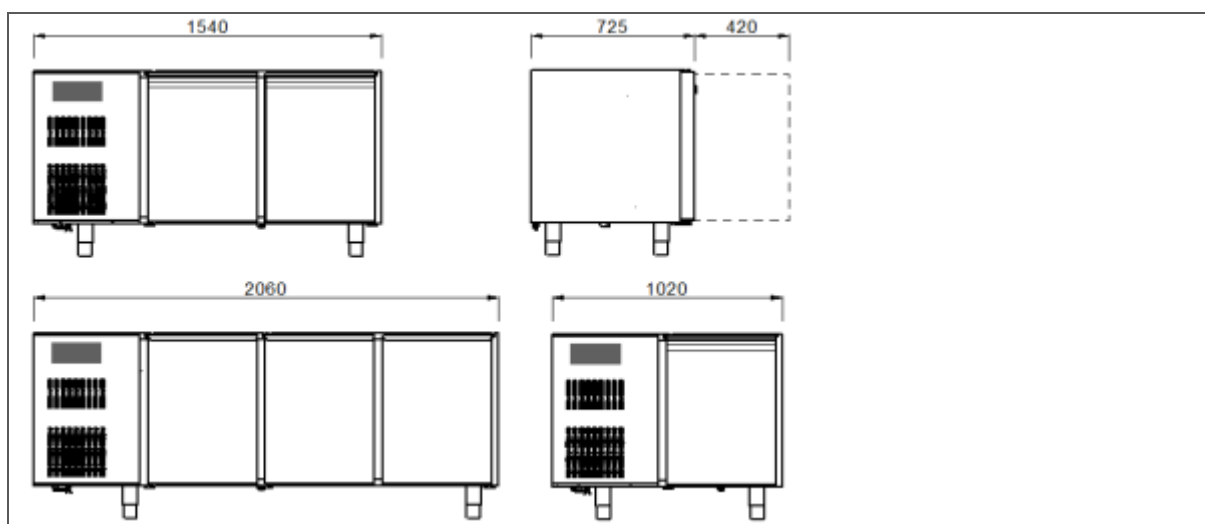

УСТАНОВКА И ЗАПУСК

Холодильные шкафы присылаются запечатанными и на поддонах.

Если в момент поставки, после открытия упаковки обнаружатся повреждения или нехватка деталей, то поступать в соответствии с параграфом “ОБЩИЕ ЗАМЕЧАНИЯ ПО ПОСТАВКЕ”.

Установку и запуск аппаратуры должен производить специализированный персонал.



Распаковывать осторожно, чтобы не повредить поверхности аппаратуры.

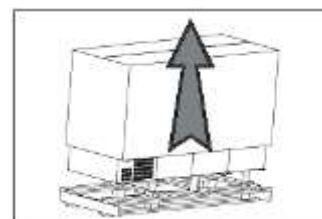

ВНИМАНИЕ: элементы от упаковки (целлофановые мешки, полистирол, пенопласт, гвозди и т.д.) не должны находиться в зоне, где находятся дети, так как составляют потенциальную опасность.

Электропогрузчиком поднять агрегат и перевезти на место его установки, при этом быть осторожными, чтобы груз не потерял равновесие.

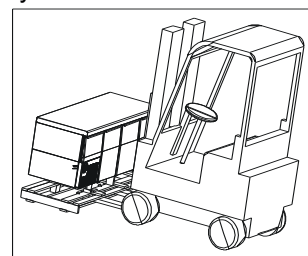

ВНИМАНИЕ: как при перестановках, так и при установке не тащить агрегат, чтобы избежать царапин и других дефектов, чтобы не опрокинуть его.

ВНИМАНИЕ: не устанавливать агрегаты вблизи источников тепла или в помещениях с повышенной температурой; это может пагубно повлиять на производительность самого агрегата, повлечь перегрузку охлаждающего устройства.



Установить оборудование на месте окончательного размещения. Убедиться в достаточной вентиляции помещения. Не выделять оборудование для среды, находящейся выше объявленного класса климата.

Удалить защитную плёнку с агрегата.

Эта операция может вызвать неприятные ощущения неопасных электрических разрядов (электро статика). Эти неприятные ощущения можно избежать или частично уменьшить, придерживая одной рукой агрегат или заземлить его, соединяя наружную оболочку с заземляющим контуром.

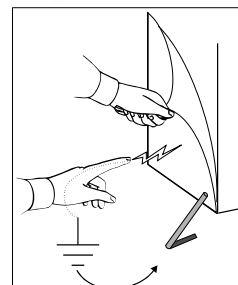

Теперь возможно отрегулировать уровень ножек агрегата.

Выравнивать агрегат, держа его немного наклонённым назад, чтобы облегчить оптимальное закрытие дверей.

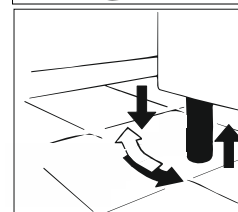

Мыть с тёплой водой и нейтральным моющим средством (как описано в главе “ЧИСТКА”) и монтировать возможные детали.

Проверить напряжение соответствует ли оно напряжению, указанному на табличке технических характеристик.

ВНИМАНИЕ: проконтролировать, чтобы розетка, была оснащена заземляющим проводом; в случае его отсутствия принять меры.

Вставить электровилку в отведённую ей розетку сети.

Агрегат должен быть кроме того включён в эквипотенциальную систему, эффективность которой проверяется относительно соответствующих норматив . Связь осуществляется с помощью винта, отмеченного опознавательной меткой “Эквипотенциальная”, расположенная в зоне компрессоров.

На этом операции по монтажу и наладке закончены.

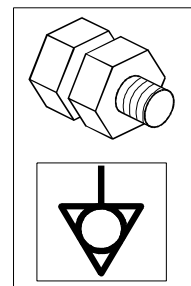

ГЕНЕРАЛЬНАЯ ЧИСТКА И ЕЖЕДНЕВНЫЙ УХОД

Для полной эксплуатации холодильника нужно осуществлять чистку и ежедневный уход.

Перед тем как начать операции следуйте следующему:

- перевести генеральный выключатель в позицию OFF
- вынуть из розетки штепсельную вилку и подождать полного размораживания холодильника.

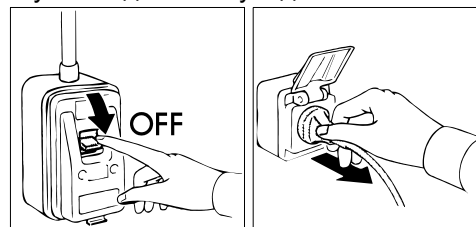

Пылесосом, кисточкой или щёткой не металлическими осторожно производить чистку группы рефрижераторов особенно прилегающая батарея.

ВНИМАНИЕ: Чистка и осмотр рефрижераторного устройства и зоны компрессоров нуждается в квалифицированном авторизированном технике, поэтому не может осуществляться простым персоналом.

Чистить внешние и внутренние поверхности водой и мылом или нейтральным моющим средством; немного добавленного в воду уксуса поможет удалить неприятные запахи. Обильно сполоснуть чистой водой и тщательно высушить.

На этом генеральные операции по чистке и уходу заканчиваются.

ОБСЛУЖИВАНИЕ ШКАФЫ ИЗ НЕРЖАВЕЮЩЕЙ СТАЛИ

ЕЖЕДНЕВНАЯ ЧИСТКА

Чтобы гарантировать безукоризненную гигиену и сохранение агрегата необходимо осуществлять периодические и/или ежедневные операции по уходу, следуя инструкциям:

1. Тщательно мыть поверхности агрегата, используя мягкую мочалку и тёплую воду с нейтральным моющим средством, мочалка должна быть хорошо выжатой, направление движений должно соответствовать направлению полировки облицовки.
2. Моющее средство не должно содержать хлор и других царапающих веществ.
 - 2.a Рекомендуются моющие средства следующих типов:
 - Дезинфицирующие моющие средства комбинированного действия; (содержащие вещества, которые понижают напряжение воды, не ионированные, хлористый натрий, вещества с нейтральной кислотностью)

- Лабораторные моющие средства, нейтральные, для ручной чистки; (содержащие вещества, которые понижают напряжение воды, смягчающие её)
 - Пищевые растворители; (содержащие вещества, которые понижают напряжение воды, вещества содержащие неоны негативно заряженные)
3. Перед использованием растворить желаемое моющее средство, придерживаясь инструкций содержащихся на этикетке.
 4. Оставить на 5 минут, чтобы произошла реакция.
 5. Тщательно прополоскать стенки агрегата мочалкой, полоская её часто в проточной воде.
 6. Добросовестно высушить, пользуясь чистой мочалкой.

ВНИМАНИЕ: запрещено пользоваться веществами и предметами, которые могут повредить поверхность, вызывая этим ржавчину.

ПИЩЕВЫЕ ПЯТНА И ЗАСОХШИЕ ПИЩЕВЫЕ ОСТАТКИ

В случае пятен от пищевых продуктов и остатков пищи в агрегатах вымыть их водой и удалить до того, как они засохнут.

Ив максимальной гигиене продукты

Если остатки пищи уже засохли следовать следующим образом:

1. Тщательно мыть поверхности агрегата, используя мягкую мочалку и тёплую воду с нейтральным моющим средством (можно использовать средства предназначенные для каждодневного ухода, применяя двойную концентрацию).
2. Замочить засохшее пятно минимум на 30 минут, смачивая каждые 5 минут намыленной мочалкой, чтобы лучше размочить засохшую пищу.
3. Когда пятно будет полностью размочено, удалить его мочалкой, намоченной тёплой водой.
4. Необходимо пользоваться деревянной лопаточкой, быть осторожным, чтобы не пошкрябать поверхность агрегата.
5. В конце процедуры советуется произвести цикл дневной чистки всех внутренних поверхностей.
6. В конце тщательно прополоскать чистой мочалкой несколько раз, ополаскивая её в проточной воде.
7. Вытереть чистой мочалкой до суха.

И зоны плохо доступные должны поддерживаться в чистоте и гигиене.

Мыть с водой и нейтральными моющими средствами.

Чтобы защитить от ржавчины решётки смазывать их силиконовым воском.

ИНСТРУКЦИИ ПО ЭКСПЛУАТАЦИИ НЕРЖАВЕЮЩЕЙ СТАЛИ

Для чистки и ухода за частями, изготовленными из нержавеющей стали придерживайтесь следующих инструкций, помня, что главное и основное правило гарантировать нетоксичность и максимальную гигиеничность продуктов.

Нержавеющая сталь имеет тончайший слой окиси, который предохраняет его от ржавчины.

Существуют средства и частицы, которые могут разрушить его и это приведет к коррозии.

До того как пользоваться тем или иным средством проконсультируйтесь у Вашего поставщика, которому Вы доверяете, пригодно ли это средство для нержавеющей стали.

В случае, когда уже существуют царапины необходимо отполировать их точайшей шерстью для НЕРЖАВЕЮЩЕЙ СТАЛИ или абразивными мочалками из синтетического волокна, начищая в сторону сатинатуры

ВНИМАНИЕ: Для чистки НЕРЖАВЕЮЩЕЙ СТАЛИ ни когда не пользоваться губками из железа и не оставлять на поверхностях ничего железного, что могло бы оставить следы ржавчины и спровоцировать загрязнение.

ОБСЛУЖИВАНИЕ ШКАФЫ VX-PET

Чтобы гарантировать безукоризненную гигиену и сохранение агрегата (66) необходимо осуществлять периодические и/или ежедневные операции по уходу.

В случае присутствия пятен от пищевых продуктов или остатков на внешней поверхности, мыть водой и устранить до того как они засохнут.

Если остатки уже засохли использовать мягкую губку, погруженную в скипидаре или спирт денатурированный.

В случае присутствия пятен от пищевых продуктов или остатков на внутренней поверхности, пользоваться белой кипящий уксус или спирт денатурированный, пользуясь мягкой тряпочкой для чистки.

Мыть в сторону лощения.

Советуется ежедневно осуществлять чистку всех внутренних поверхностей аппарата. Избегать пользоваться абразивными кремами или стальной губкой, ацетоном, аммиаком.

В конце тщательно прополоскать чистой мочалкой несколько раз, ополаскивая её в проточной воде.

Вытереть чистой мочалкой до суха.

И зоны плохо доступные должны поддерживаться в чистоте и гигиене. Мыть с водой и нейтральными моющими средствами.

ВЫБРОС ОТХОДОВ И ИХ РАЗМЕЩЕНИЕ

СКЛАДИРОВАНИЕ ОТХОДОВ

В конце жизненного цикла продукта не выбрасывать аппаратуру в окружающую среду. Перед выбросом двери аппаратуры должны быть демонтированы.

Допускается временное складирование отдельных отходов под видом выброса посредством обработки окончательного складирования. Руководствуясь действующими законами по охране окружающей среды страны потребителя.

ПРОЦЕДУРА РАЗБОРКИ АППАРАТУРЫ

В каждой стране существуют свои законы по выбросу ненужной аппаратуры, но существуют и общие правила.

Главным образом ненужную аппаратуру сдают в специальные центры по демонтажу.

Разобрать аппаратуру по природе своего химического состава, помня, что в состав компрессора входят смазочные масла и охлаждающая жидкость, которые могут быть использованы заново в выпуске холодильников и, что компоненты холодильника это специальные отходы ассимилируемые службой переработки отходов.

Сдавать на выброс непригодную аппаратуру, разбирая электрические части и любые замки для избежания закрытия кого-либо внутри.

ОПЕРАЦИИ ПО РАЗБОРКЕ ДОЛЖНЫ ПРОВОДИТЬСЯ КВАЛИФИЦИРОВАННЫМ ПЕРСОНАЛОМ.

БЕЗОПАСНОСТЬ ПРИ СБОРЕ ОТХОДОВ ЭЛЕКТРИЧЕСКОГО И ЭЛЕКТРОННОГО ОБОРУДОВАНИЯ (ДИРЕКТИВА 2002/96/ЕС)

Не распространять вредный материал в окружающую среду. Осуществлять переработку в соответствии с действующими законами в этой области.

Согласно директиве 2002/96 (Отходы Электрического и Электронного Оборудования - WEEE), пользователь обязан сдать указанные отходы в специальное место переработки, или вернуть их продавцу, еще установленными при новом приобретении.

Вся аппаратура, которая должна быть переработанная согласно директиве WEEE 2002/96, отмечена

одним специальным символом .

Незаконная переработка Отходов Электрического и Электронного оборудования наказуема санкциями, отрегулированными действующими законами по территории, на которой установлено нарушение.

Отходы Электрического и Электронного оборудования могут содержать опасные вещества с эффектами потенциально вредными на окружающую среду и на здоровье людей. Советуется осуществлять этот сбор правильным способом.

ОБЩИЕ ЗАМЕЧАНИЯ ПО ПОСТАВКЕ

В момент поставки удостовериться в целостности упаковки и что в течение поставки нет повреждений.

После распаковки холодильника необходимо удостовериться в наличие всех частей и компонентов и в соответствии характеристик специфики вашего заказа.

Если это не так, немедленно сообщить поставщику.

Спасибо Вам за Ваш удачный выбор, будем надеется что Вы сможете самым лучшим образом использовать наши холодильные шкафы, следуя нашим указаниям и предосторожностям, внесенным в это руководство.

Но помните, что запрещено любое воспроизведение настоящего руководства, и что постоянный поиск новшеств и качества технологии в любой момент и без предупреждения может изменить описанные здесь характеристики.

ДОПОЛНЕНИЯ

По желанию оборудование может сопровождаться следующими аксессуарами (смотрите "*Общая Каталог*").

ИНСТРУКЦИИ ПО САМОКОНТРОЛЮ ОБОРУДОВАНИЯ

ВНИМАНИЕ: Сырые овощи, яйца и куриное мясо **НЕ** должны храниться в одних и тех же отделениях холодильника. Куриное мясо храниться отдельно.

ВНИМАНИЕ: Избегать хранение продуктов, которые имеют температуру хранения от 10 °C до 60 °C. Пользоваться специальными аппаратами (понижители температуры) для понижения температуры внутри продуктов.

ВНИМАНИЕ: Используя продукты, хранящиеся в холодильниках, необходимо контролировать указанный на упаковке срок годности и использовать продукты, срок истечения годности которых ближе других. Если срок годности продукта истек, продукт немедленно удалить из холодильника и сообщить об этом ответственному работнику Предприятия, в котором работаете.

ВНИМАНИЕ: Легко портящиеся продукты должны выниматься из холодильника в момент использования и класться немедленно на место, чтобы они находились вне холодильника меньшее время.

ВНИМАНИЕ: Не замораживать продукты вторично.

ВНИМАНИЕ: Пронумеровать холодильные аппараты и контролировать два раза в день их температуру, записывая показатели в специальный журнал, который нужно хранить 24 месяца.

ВНИМАНИЕ: Возможное время отключение электричества от холодильника можно контролировать электронными часами, для того чтобы удалить продукты, которые могли быть испорченными.

Максимальные температуры, разрешенные для продуктов

Продукт	Нормальная температура складировки (°C)	Максимальная температура транспортировки (°C)
Молоко свежее пастеризованное	0÷+4	9
Свежие сливки	0÷+4	9
Йогурт, творог и свежие сыры	0÷+2	9
Рыбные замороженные изделия	0÷+2	0÷+4
Мясо говяжье и свиное	0÷+3	10
Куриное мясо	0÷+4	8
Мясо кролика	0÷+2	8
Мелкая дичь	0÷+2	8
Крупная дичь	0÷+2	8
Потроха	0÷+3	8
Свежезамороженные	-23÷-24	-18
Мороженное конфекционное	-18÷-20	-18
Фрукты и овощи	0÷+4	окружающей среды

ТЕХНИЧЕСКИЕ ХАРАКТЕРИСТИКИ

Технические характеристики описаны на последней странице инструкции.

ПАНЕЛИ УПРАВЛЕНИЯ

Все типы устройства оснащены генеральным выключателем и терморегулятором:

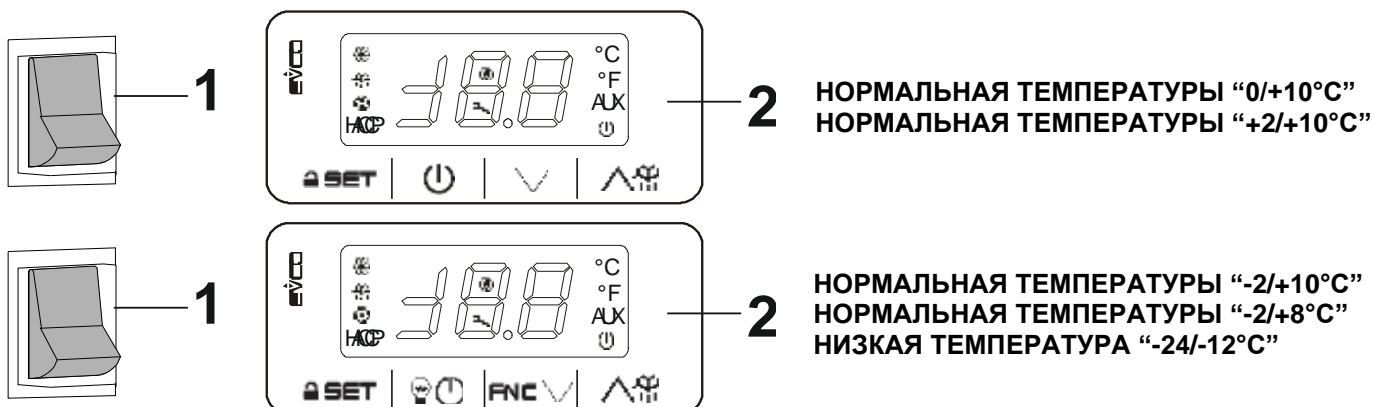

ЗАПУСК И ЭКСПЛУАТАЦИЯ

Для запуска установки проделать следующие операции:

- вставить вилку в розетку питания;
- поставить выключатель в позицию ON;

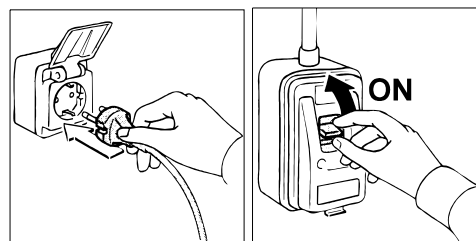

- нажать генеральный выключатель (1); включиться зеленый индикатор генерального выключателя; теперь можно выставить рабочую температуру Терморегулятором (2).

после определенного времени проконтролируйте по дисплею терморегулятора (2), что температура внутри холодильника соответствует выставленной температуре.

БЛОКИРОВАНИЕ/РАЗБЛОКИРОВАНИЕ КЛАВИАТУРЫ

Чтобы заблокировать клавиатуру:

- убедиться, что в данный момент в ходе нет никакой процедуры
- не действуют в течение 30 сек: дисплей высветит "Loc" на 1 сек и клавиатура автоматически блокируется.

Чтобы разблокировать клавиатуру:

- нажать кнопку в течение 1 сек: дисплей высветит "Un" на 1 сек.

НАСТРОЙКА РАБОТЫ И КОНФИГУРАЦИЯ ПАРАМЕТРОВ

НОРМАЛЬНАЯ ТЕМПЕРАТУРЫ "0/+10°C" "+2/+10°C"

Setting the working setpoint

- Make sure that the keyboard is not locked and that no procedure is in progress
- Touch the **SET** key: the LED will flash
- Touch the or key within 15 s; see also r1 and r2 parameters
- Touch the **SET** key or do not operate for 15 s: the LED will switch off after which, the device will exit the procedure.

To exit the procedure before the operation is complete:

- Touch the  (any changes will not be saved)





The working setpoint can also be set via **SP** parameter.

Working setpoints



LABEL	MIN.	MAS.	U.M.	WORKING SETPOINT
	r1	r2	°C/°F (1)	working setpoint; see also r0 and r12

Setting the configuration parameters





To access the procedure:

- Make sure no procedure is in progress
- Touch the  key for 4 s: the display will show "PA"
- Touch the 
- Touch the  or  key within 15 s to set the value determined with the "PAS" parameter (the parameter is set at "-19" by default)
- Touch the  or do not operate for 15 s: the display will show "SP"

To select a parameter:

- Touch the  or  key

To set a parameter:

- Touch the  key
- Touch the  or  key within 15 s.
- Touch the  key or do not operate for 15 s.

To exit the procedure:

- Touch the  key for 4 s or do not operate for 60 s (any changes will be saved)

Configuration parameters

LABEL	MIN.	MAS.	U.M.	WORKING SETPOINT
SP	r1	r2	°C/°F (1)	working setpoint; see also r0 and r12

LABEL	MIN.	MAS.	U.M.	ANALOG INPUTS
CA1	-25	25	°C/°F (1)	room probe offset
CA2	-25	25	°C/°F (1)	if P4 = 1, evaporator probe offset if P4 = 2, condenser probe offset
P0	0	1	-	probe type (0 = PTC; 1 = NTC)
P1	0	1	-	degree Celsius decimal point (during normal operation) 1 = YES
P2	0	1	-	unit of measurement for temperature (2) 0 = °C (Celsius degree; resolution depends on P1 parameter) 1 = °F (Fahrenheit degree; resolution is 1 °F)
P4	0	2	-	second input function 0 = digital input (door switch or multifunction) 1 = analog input (evaporator probe) 2 = analog input (condenser probe)
P5	0	2	-	magnitude displayed during normal operation 0 = room temperature 1 = working setpoint 2 = if P4 = 0, "- -" if P4 = 1, evaporator temperature if P4 = 2, condenser temperature
P8	0	250	0,1s	delayed display of temperature changes as detected by the probes

LABEL	MIN.	MAS.	U.M.	MAIN REGULATOR
r0	0:1	15	°C/°F (1)	working setpoint differential; see also r12
r1	-99	r2	°C/°F (1)	minimum working setpoint
r2	r1	99	°C/°F (1)	maximum working setpoint
r4	0	99	°C/°F (1)	working setpoint increase during the "energy saving" function; see also i0, i10 and HE2
r5	0	1	-	cooling or heating operation (3) 0 = cooling 1 = heating
r12	0	1	-	working setpoint differential type 0 = asymmetric 1 = symmetric

LABEL	MIN.	MAS.	U.M.	COMPRESSOR PROTECTION SYSTEM
C0	0	240	min	delay in switching on of compressor after the device switches on (4)
C2	0	240	min	minimum compressor switch-off duration (5)
C3	0	240	s	minimum duration of compressor switch on time
C4	0	240	min	duration of compressor switch off time during a room temperature probe error (code "Pr1"); see also C5
C5	0	240	min	duration of compressor switch on time during a room temperature probe error (code "Pr1"); see also C4
C6	0	199	°C/°F (1)	condenser temperature is higher than that at which the condenser overheating alarm is activated (code "COH") (6)
C7	0	199	°C/°F (1)	condenser temperature above which the compressor shut down alarm is activated (code "CSd")
C8	0	15	min	compressor shut down alarm delay (code "CSd") (7)

LABEL	MIN.	MAS.	U.M.	DEFROST
d0	0	99	h	if d8 = 0, 1 or 2, defrost interval 0 = interval defrost will never be activated

				if d8 = 3, maximum defrost interval
d2	-99	99	°C/°F (1)	evaporator temperature at end of defrost; see also d3
d3	0	99	min	if P4 = 0 or 2, defrost duration if P4 = 1, maximum defrost duration; see also d2 0 = defrost will not be activated
d4	0	1	-	defrost when device is switched on (4) 1 = YES
d5	0	99	min	if d4 = 0, minimum time between switching on of device and activation of defrost (4) if d4 = 1, delay in activation of defrost after device is switched on (4)
d6	0	2	-	temperature displayed during defrost (only if P5 = 0) 0 = room temperature 1 = if on activation of defrost, the room temperature is below the "work setpoint + Δt ", at maximum "work setpoint + Δt "; if on activation of defrost, the room temperature is above "work setpoint + Δt ", at maximum the room temperature on activation of defrost (8) (9) 2 = label "dEF"
d7	0	15	min	dripping duration (during dripping the compressor will remain switched off)
d8	0	3	-	defrost activation methods 0 = AT INTERVALS - FOR TIME - defrost will be activated once the device has altogether been running for time d0 1 = AT INTERVALS - FOR COMPRESSOR SWITCH-ON - defrost will be activated once the compressor has altogether been switched on for time d0 2 = AT INTERVALS - FOR EVAPORATOR TEMPERATURE - defrost will be activated when the evaporator temperature has remained below the temperature d9 for a total time of d0 (10) 3 = ADAPTIVE - defrost will be activated at intervals, whose duration will each time depend on the duration of compressor switch-ons, the evaporator temperature and the door switch input activation; see also d18, d19, d20, d22, i13 and i14 (10)
d9	-99	99	°C/°F (1)	evaporator temperature is higher than that at which the defrost interval counter is suspended (only if d8 = 2)
d11	0	1	-	defrost alarm switches off once maximum time limit has been reached (code "dFd"); only if P4 = 1 and in absence of evaporator probe error (code "Pr2") 1 = YES
d16	0	999	min	defrost interval (defrost will be activated when the compressor has been on totally, with the evaporator temperature below that of d22, for time d16; only if d8 = 3) 0 = defrost will never be activated due to the effect of this condition
d18	0	999	min	defrost interval (defrost will be activated when the compressor has been on totally, with the evap. temp. below that of d22, for time d18; only if d8 = 3) 0 = defrost will never be activated due to the effect of this condition
d19	0	40	°C/°F (1)	evaporator temperature below which the defrost is activated (relative to the evaporator temperatures average, or "evaporator temperatures average - d19"; only if d8 = 3)
d20	0	999	min	minimum consecutive time the compressor must be switched on such as to provoke the defrost activation 0 = defrost will never be activated due to the effect of this condition
d22	0	19,9	°C/°F (1)	evaporator temperature above which the defrost interval count shall be suspended (relating to the average of evaporator temperatures, that is to say, "evaporator temperatures average + d22"; only if d8 = 3); see also d18

LABEL	MIN.	MAS.	U.M.	TEMPERATURE ALARMS (11) (12)
A1	0	99	°C/°F (1)	room temperature below which the minimum temperature alarm is triggered (code "AL"; it concerns the working setpoint, that is to say, "working setpoint - A1"); see also A11 0 = alarm absent
A4	0	99	°C/°F (1)	room temperature above which the maximum temperature alarm is triggered (code "AH"; it concerns the working setpoint, that is to say, "working setpoint + A4"); see also A11 0 = alarm absent
A6	0	99	10 min	delay in maximum temperature alarm (code "AH") after the device is switched on (4)
A7	0	199	min	minimum temperature alarm delay (code "AL") and maximum temperature alarm delay (code "AH")
A11	0,1	15	°C/°F (1)	differential of A1 and A4 parameters

LABEL	MIN.	MAS.	U.M.	DIGITAL INPUTS
i0	0	4	-	effect caused by the activation of the digital input 0 = no effect 1 = DOOR SWITCH - DOOR SWITCH INPUT ALARM ACTIVATION (code "id") - the compressor will be switched off (at maximum for time i3 or until the input is deactivated); see also i2 (13) 2 = MULTIFUNCTION - ACTIVATION OF "ENERGY SAVING" FUNCTION - the "energy saving" function will be activated (just with effect on the compressor, until the input is deactivated); see also r4 3 = MULTIFUNCTION - ACTIVATION OF MULTIFUNCTION INPUT ALARM (code "iA") - the device will continue to operate normally; see also i2 4 = MULTIFUNCTION - ACTIVATION OF THE MAXIMUM PRESSURE SWITCH ALARM (code "iA") - the compressor will be switched off (until the input is deactivated); see also i2
i1	0	1	-	type of digital input contact 0 = normally open (active input with closed contact) 1 = normally closed (active input with open contact)
i2	-1	120	min	if i0 = 1, delay in signalling of door switch input alarm (code "id") -1 = the alarm will not be signalled if i0 = 3, delay in signalling of multifunction input alarm (code "iA") -1 = the alarm will not be signalled if i0 = 4, delay in switching on of compressor after the deactivation of the maximum pressure switch alarm (code "iA") -1 = reserved
i3	-1	120	min	maximum duration of the effect caused by the activation of the door switch input on the compressor -1 = the effect will last until the input is deactivated
i10	0	999	min	time that must pass in absence of door switch input activations (after the room temperature has reached the working setpoint) for the "energy saving" function to be activated; see also r4 and HE2 0 = the function will never be activated due to the effect of this condition
i13	0	240	-	number of door switch input activations such as to provoke the defrost activation 0 = defrost will never be activated due to the effect of this condition
i14	0	240	min	minimum duration of the door switch input activation such as to provoke the defrost activation

				0 = defrost will never be activated due to the effect of this condition
--	--	--	--	---

LABEL	MIN.	MAS.	U.M.	ENERGY SAVING
HE2	0	99	min	maximum duration of the "energy saving" function activated due to the effect of absence of door switch input activation; see also r4 and i10 0 = the function will last until the input is activated
HE3	0	240	min	time interval with no key strokes, after which the "low consumption" function is activated 0 = the mode shall never be aac

LABEL	MIN.	MAS.	U.M.	VARIOUS
POF	0	1	-	key activation 1 = YES
PAS	-99	999	-	access password for the configuration parameters 0 = the password need not be set

- (1) the unit of measurement depends on P2
- (2) properly set the parameters corresponding to the regulators after setting P2 parameter
- (3) if r5 parameter is set at 1, the "energy saving" function and the defrost management will be switched off
- (4) the parameter has effect even after an interruption in the power supply that occurs while the device is switched on
- (5) the time set by parameter C2 is counted also when the device is off
- (6) the differential of parameter is 2.0°C/4°F
- (7) if when the device is switched on, the condenser temperature is already above that established in C7 parameter, then C8 parameter will not have effect
- (8) the value Δt depends on r12 parameter (r0 if r12 = 0, r0/2 if r12 = 1)
- (9) the display restores normal operation when, at the end of the dripping phase, room temperature falls below the value that locked the display (or if a temperature alarm is triggered)
- (10) if P4 parameter is set at 0 or 2, the device will function as if d8 parameter were set at 0
- (11) during defrost and dripping, the maximum temperature alarm is absent, provided that it was triggered after defrost activation.
- (12) during activation of the door switch input, the maximum temperature alarm is absent, provided the alarm was signaled after the activation of the input
- (13) the compressor is switched off 10 s after the activation of the input

НОРМАЛЬНАЯ ТЕМПЕРАТУРЫ “-2/+10°C” “-2/+8°C” - НИЗКАЯ ТЕМПЕРАТУРА “-24/-12°C”

Setting the working setpoint

- Make sure that the keyboard is not locked and that no procedure is in progress
- Touch the key: the LED will flash
- Touch the or key within 15 s; see also r1 and r2 parameters
- Touch the key or do not operate for 15 s: the LED will switch off after which, the device will exit the procedure.

To exit the procedure before the operation is complete:

- Touch the (any changes will not be saved)

The working setpoint can also be set via **SP** parameter.

Working setpoints

LABEL	MIN.	MAS.	U.M.	WORKING SETPOINT
r1	r2		°C/°F	working setpoint; see also r0 and r12

Setting the configuration parameters

To access the procedure:

- Make sure no procedure is in progress
- Touch the key for 4 s: the display will show “PA”
- Touch the
- Touch the or key within 15 s to set the value determined with the “PAS” parameter (the parameter is set at “-19” by default)
- Touch the or do not operate for 15 s: the display will show “SP”

To select a parameter:

- Touch the or key

To set a parameter:

- Touch the key
- Touch the or key within 15 s.
- Touch the key or do not operate for 15 s.

To exit the procedure:

- Touch the key for 4 s or do not operate for 60 s (any changes will be saved)

Configuration parameters

LABEL	MIN.	MAS.	U.M.	WORKING SETPOINT
SP	r1	r2	°C/°F	working setpoint; see also r0 and r12

LABEL	MIN.	MAS.	U.M.	ANALOGUE INPUTS
CA1	-25	25	°C/°F	cabinet probe offset if P4 = 3, air in probe offset
CA2	-25	25	°C/°F	evaporator probe offset
CA3	-25	25	°C/°F	auxiliary probe offset

P0	0	1	-	probe type 0=PTC 1=NTC
P1	0	1	-	enable °C decimal point 0 = no 1 = yes
P2	0	1	-	temperature unit of measurement 0 = °C 1 = °F
P3	0	2	-	evaporator probe function 0 = disabled 1 = defrost + fan 2 = fan
P4	0	3	-	configurable input function 0 = digital input 1 = condenser probe 2 = critical temperature probe 3 = air out probe if P4 = 3, regulation temperature = product temperature (CPT)
P5	0	4	-	value displayed 0 = regulation temperature 1 = setpoint 2 = evaporator temperature 3 = auxiliary temperature 4 = air in temperature
P7	0	100	%	air in weight for calculated product temperature (CPT) CPT = $\{[(P7 \times (\text{air in})) + [(100 - P7) \times (\text{air out})]: 100\}$
P8	0	250	0,1 s	display refresh time

LABEL	MIN.	MAS.	U.M.	REGULATION
r0	0.1	15	°C/°F	setpoint differential
r1	-99	r2	°C/°F	minimum setpoint
r2	r1	99	°C/°F	maximum setpoint
r4	0	99	°C/°F	setpoint offset in energy saving
r5	0	1	-	cooling or heating operation 0 = cooling 1 = heating
r6	0	99	°C/°F	setpoint offset in overcooling/overheating
r7	0	240	min	overcooling/overheating duration
r8	0	2	-	DOWN key additional function 0 = disabled 1 = overcooling/overheating 2 = energy saving
r12	0	1	-	position of the r0 differential 0 = asymmetric 1 = symmetric

LABEL	MIN.	MAS.	U.M.	COMPRESSOR
C0	0	240	min	compressor on delay after power-on
C2	0	240	min	compressor off minimum time
C3	0	240	s	compressor on minimum time
C4	0	240	min	compressor off time during cabinet probe alarm
C5	0	240	min	compressor on time during cabinet probe alarm
C6	0	200	°C/°F	threshold for high condensation warning
C7	0	200	°C/°F	threshold for high condensation alarm
C8	0	15	min	high condensation alarm delay
C10	0	9999	h	compressor hours for service 0 = disabled
C11	0	240	s	second compressor switch-on delay
C12	0	10	-	number of start-ups for compressor rotation 0 = disabled

LABEL	MIN.	MAS.	U.M.	DEFROST
d00	0	1	-	enable parameters type b 0 = no 1 = yes
d01	r1	r2	°C/°F	setpoint threshold to enable parameters type b if SP > d01
d0	0	99	h	automatic defrost interval 0 = only manual if d8 = 3, maximum interval
d0b	0	99	h	automatic defrost interval 0 = only manual if d8 = 3, maximum interval
d1	0	2	-	defrost type 0 = electric 1 = hot gas 2 = compressor stopped
d1b	0	2	-	defrost type 0 = electric 1 = hot gas 2 = compressor stopped
d2	-99	99	°C/°F	threshold for defrost end
d2b	-99	99	°C/°F	threshold for defrost end
d3	0	99	min	defrost duration if P3 = 1, maximum duration

d3b	0	99	min	defrost duration if P3 = 1, maximum duration
d4	0	1	-	enable defrost at power-on 0 = no 1 = yes
d5	0	99	min	defrost delay after power-on
d6	0	2	-	value displayed during defrost 0 = regulation temperature 1 = display locked 2 = dEF label
d7	0	15	min	dripping time
d7b	0	15	min	dripping time
d8	0	3	-	defrost interval counting mode 0 = device on hours 1 = compressor on hours 2 = hours evaporator temperature < d9 3 = adaptive 4 = real time
d9	-99	99	°C/°F	evaporation threshold for automatic defrost interval counting
d11	0	1	-	enable defrost timeout alarm 0 = no 1 = yes if d1 = 0 or 1, enabled with SP < 0, if d1 = 2, disabled
d15	0	99	min	compressor on consecutive time for hot gas defrost
d16	0	99	min	pre-dripping time for hot gas defrost
d18	0	999	min	adaptive defrost interval if compressor on + evaporator temperature < d22 0 = only manual
d19	0	40	°C/°F	threshold for adaptive defrost (relative to optimal evaporation temperature) optimal evaporation temperature - d19
d20	0	999	min	compressor on consecutive time for defrost 0 = disabled
d21	0	500	min	compressor on consecutive time for defrost after power-on and overcooling if (regulation temperature - setpoint) > 10°C/20 °F 0 = disabled
d22	0	10	°C/°F	evaporation threshold for adaptive defrost interval counting (relative to optimal evaporation temperature) optimal evaporation temperature + d22

LABEL	MIN.	MAS.	U.M.	ALARMS
AA	0	2	-	select value for high/low temperature alarms 0 = regulation temperature 1 = evaporator temperature 2 = auxiliary temperature
A1	0	99	°C/°F	threshold for low temperature alarm
A2	0	2	-	low temperature alarm type 0 = disabled 1 = relative to setpoint 2 = absolute
A4	0	99	°C/°F	threshold for high temperature alarm
A5	0	2	-	high temperature alarm type 0 = disabled 1 = relative to setpoint 2 = absolute
A6	0	99	10 min	high temperature alarm delay after power-on
A7	0	240	min	high/low temperature alarms delay
A8	0	240	min	high temperature alarm delay after defrost
A9	0	240	min	high temperature alarm delay after door closing
A10	0	240	min	power failure duration for alarm recording
A11	0,1	15	°C/°F	high/low temperature alarms reset differential

LABEL	MIN.	MAS.	U.M.	FANS
F0	0	4	-	evaporator fan mode during normal operation 0 = off 1 = on 2 = according to F15 and F16 if compressor off, on if compressor on 3 = thermoregulated (with F1 and F1A) 4 = thermoregulated (with F1 and F1A) if compressor on
F0b	0	4	-	evaporator fan mode during normal operation 0 = off 1 = on 2 = according to F15 and F16 if compressor off, on if compressor on 3 = thermoregulated (with F1 and F1A) 4 = thermoregulated (with F1 and F1A) if compressor on
F1	-99	99	°C/°F	threshold for evaporator fan off
F1A	-99	99	°C/°F	threshold for evaporator fan on if F1A > F1, F1 differential = 2 °C/4 °F
F2	0	2	-	evaporator fan mode during defrost and dripping 0 = off 1 = on 2 = according to F0
F2b	0	2	-	evaporator fan mode during defrost and dripping 0 = off 1 = on 2 = according to F0
F3	0	15	min	evaporator fan off maximum time
F3b	0	15	min	evaporator fan off maximum time
F4	0	240	10 s	evaporator fan off time during energy saving

F5	0	240	10 s	evaporator fan on time during energy saving
F7	-99	99	°C/°F	threshold for evaporator fan on after dripping (relative to setpoint) setpoint + F7
F9	0	240	s	evaporator fan off delay after compressor off
F10	0	99	°C/°F	difference "cabinet temperature - evaporator temperature" for evaporator fan on differential = 2 °C/4 °F
F11	0	99	°C/°F	threshold for condenser fan on
F12	0	240	s	condenser fan off delay after compressor off
F13	0	15	°C/°F	differential F11
F15	0	240	s	evaporator fan off time with compressor off if F0 = 2
F16	0	240	s	evaporator fan on time with compressor off if F0 = 2

LABEL	MIN.	MAS.	U.M.	DIGITAL INPUTS
i0	0	5	-	door switch input function 0 = disabled 1 = compressor + evaporator fan off 2 = evaporator fan off 3 = cabinet light on 4 = compressor + evaporator fan off, cabinet light on 5 = evaporator fan off + cabinet light on
i1	0	1	-	door switch input activation 0 = with contact closed 1 = with contact open
i2	-1	120	min	open door alarm delay -1 = disabled
i3	-1	120	min	regulation inhibition maximum time with door open -1 = until the closing
i5	0	7	-	door switch/multi-purpose input function 0 = disabled 1 = energy saving 2 = iA alarm 3 = button-operated load on 4 = device on/off 5 = Cth alarm 6 = th alarm 7 = compressor + evaporator fan off, cabinet light on 8 = evaporator fan off + cabinet light on
i6	0	1	-	door switch/multi-purpose input activation 0 = with contact closed 1 = with contact open
i7	0	120	min	multi-purpose input alarm delay -1 = disabled if i5 = 5 or 6, compressor on delay after alarm reset
i10	0	999	min	door closed consecutive time for energy saving after regulation temperature < SP 0 = disabled
i13	0	240	-	number of door openings for defrost 0 = disabled
i14	0	240	min	door open consecutive time for defrost 0 = disabled

LABEL	MIN.	MAS.	U.M.	DIGITAL OUTPUTS
uc1	0	12	-	relay K1 configuration 0 = compressor 1 = defrost 2 = evaporator fan 3 = cabinet light 4 = demisting 5 = button-operated load 6 = alarm 7 = door heaters 8 = heater for neutral zone 9 = condenser fan 10= on/stand-by 11= compressor 2 12= disabled
uc2	0	12	-	relay K2 configuration (like uc1)
uc3	0	12	-	relay K3 configuration (like uc2)
uc4	0	12	-	relay K4 configuration (like uc3)
u2	0	1	-	enable cabinet light and buttonoperated load in stand-by 0 = no 1 = yes manual
u4	0	1	-	enable alarm output off silencing the buzzer 0 = no 1 = yes
u5	-99	99	°C/°F	threshold for door heaters on differential = 2 °C/4 °F
u6	0	120	min	demisting on duration 0 = manual
u7	-99	99	°C/°F	neutral zone threshold for heating (relative to setpoint) setpoint + u7
u8	1	15	°C/°F	u7 differential

LABEL	MIN.	MAS.	U.M.	ENERGY SAVING (if r5 = 0)
HE2	0	999	min	energy saving maximum duration -1 = until the door opening

LABEL	MIN.	MAS.	U.M.	REAL TIME ENERGY SAVING (if r5 = 0)
H01	0	23	h	Daily energy saving time
H02	0	24		Daily energy saving maximum duration

LABEL	MIN.	MAS.	U.M.	REAL TIME DEFROST (if d8 = 4)
Hd1	-	-	-	1st daily defrost time h= disabled
Hd2	-	-	-	2st daily defrost time h= disabled
Hd3	-	-	-	3st daily defrost time h= disabled
Hd4	-	-	-	4st daily defrost time h= disabled
Hd5	-	-	-	5st daily defrost time h= disabled
Hd6	-	-	-	6st daily defrost time h= disabled

LABEL	MIN.	MAS.	U.M.	SAFETIES
Pbu	0	2	-	selecting the event for buzzer activation 0 = disabled 1 = alarms 2 = keys and alarms
POF	0	1	-	enable ON/STAND-BY key 0 = no 1 = yes
PAS	-99	999	-	password
PA1	-99	999	-	level 1 password
PA2	-99	999	-	level 2 password



LABEL	MIN.	MAS.	U.M.	REAL TIME CLOCK
POF	0	1	-	enable clock 0 = no 1 = yes

LABEL	MIN.	MAS.	U.M.	DATA-LOGGING EVLINK
bLE	0	99	-	enable Bluetooth 0 = free 1 = forced for EVconnect or EPoCA 2... 99 = EPoCA local network address
rE0	0	240	min	data-logger sampling interval
rE1	0	5	-	recorded temperature 0 = none 1 = cabinet 2 = evaporator 3 = auxiliary 4 = cabinet and evaporator 5 = all

LABEL	MIN.	MAS.	U.M.	MODBUS
LA	1	247	-	MODBUS address
Lb	0	3	-	MODBUS baud rate 0 = 2,400 baud 1 = 4,800 baud 2 = 9,600 baud 3 = 19,200 baud parity even

УПРАВЛЕНИЕ ВЛАЖНОСТЬЮ (только для аппаратов Pastry & Bakery)





Возможно задавать показатели влажности по необходимости относительно продуктов, которые будут сохраняться:

- Убедитесь, что клавиатура не заблокирована и процедура не запущена
- нажмите кнопку **FNC**  для 2 с: на дисплее будет отображаться знак, соответствующий значению влажности (**rH⁺** = высокая влажность или **rH⁻** = низкая влажность)
- нажмите клавишу **SET** для изменения параметра с
- после редактирования нажмите кнопку   для подтверждения и выхода из процедуры.

СИГНАЛИЗАЦИИ

НОРМАЛЬНАЯ ТЕМПЕРАТУРЫ "0/+10°C" "+2/+10°C"

Signals

LED	MEANING
	Compressor LED If the LED is on, the compressor is on If the LED is flashing: - the working setpoint is in the process of being set - a compressor protection will be in progress
	Defrost LED If the LED is on, defrost is in progress If the LED is flashing, dripping will be in progress
	Energy saving LED If the LED is on and the display is switched on, the "energy saving" function is in progress If the LED is on and the display is switched off, the "low consumption" function is in progress; touch a key to restore normal display
°C	Celsius degrees LED If the LED is on, the unit of measurement for temperature is Celsius degrees
°F	Fahrenheit degrees LED If the LED is on, the unit of measurement for temperature is Fahrenheit degrees
	LED on/stand-by If the LED is on, the device is switched off

Signals

CODE	MEANING
Loc	the keyboard is blocked
- - -	the operation requested is not available
dEF	defrost is in progress

Alarms

CODE	MEANING
AL	Minimum temperature alarm Solutions: - check the room temperature; see A1 parameter Main consequences: - the device will continue to operate normally
AH	Maximum temperature alarm Solutions: - check the room temperature; see A4 parameter Main consequences: - the device will continue to operate normally
id	Door switch input alarm Solutions: - check the causes of the activation of the input; see i0 and i1 parameters Main consequences: - the effect established with the i0 parameter
dFd	Defrost alarm switched off because maximum time has been reached Solutions: - check the integrity of the evaporator probe; see d2, d3 and d11 parameters - touch a key to restore normal display Main consequences: - the device will continue to operate normally

When the cause of the alarm disappears, the device restores normal operation, except for the following alarms:
 - compressor shut down alarm (code "CSd") which requires the switching off of the device or the temporary suspension of the power supply.
 - defrost alarm switched off because maximum time has been reached (code "dFd") which requires the touching of a key

Errors







CODE	MEANING
Pr1	Room temperature probe error Solutions:

	<ul style="list-style-type: none"> - check that the probe is the PTC or NTC type; see P0 parameter - check the device-probe connection - check room temperature Main consequences: <ul style="list-style-type: none"> - compressor activity will depend on C4 and C5 parameters - the defrost will not be activated
Pr2	Evaporator probe or condenser probe error Solutions: <ul style="list-style-type: none"> - the same as in the previous example, but with regard to the evaporator probe or the condenser probe Main consequences: <ul style="list-style-type: none"> - if P4 parameter is set at 1, the defrost interval will last for the amount of time set with d3 parameter - if P4 parameter is set at 1 and d8 parameter is set at 2 or to 3, the device will operate as if d8 parameter were set at 0 - if P4 parameter is set at 2, the condenser overheated alarm (code "COH") will never be activated - if P4 parameter is set at 2, the compressor shut down alarm (code "CSd") will never be activated

When the cause of the error disappears, the device restores normal operation.

НОРМАЛЬНАЯ ТЕМПЕРАТУРЫ "-2/+10°C" "-2/+8°C" - НИЗКАЯ ТЕМПЕРАТУРА "-24/-12°C"

Signals

LED	MEANING
	Compressor LED - If the LED is on, the compressor is on - If the LED is flashing: - the working setpoint is in the process of being set - a compressor protection will be in progress
	Defrost LED - If the LED is on, defrost is in progress - pre-dripping is in progress If the LED is flashing: - defrost will be requested but a compressor protection will be in progress - dripping will be in progress - defrost will be requested but a compressor minimum switch-on shall be in progress
	Evaporator fan LED If the LED is on the evaporator fan will be on If the LED is flashing evaporator fan standstill will be in progress
HACCP	Saved HACCP alarm in EVlink
AUX	Auxiliary LED If the LED is on: - the door resistances will be lit
	Energy saving LED If the LED is on and the display is switched on, the "energy saving" function is in progress If the LED is on and the display is switched off, the "low consumption" function is in progress; touch a key to restore normal display
	Maintenance LED if it is on, the compressor must be maintained
°C	Celsius degrees LED If the LED is on, the unit of measurement for temperature is Celsius degrees If it is flashing, the "rapid cooling" or "rapid heating" function will be in progress
°F	Fahrenheit degrees LED If the LED is on, the unit of measurement for temperature is Fahrenheit degrees If it is flashing, the "rapid cooling" or "rapid heating" function will be in progress
	LED on/stand-by If the LED is on, the device is switched off ("standby" status)

Signals

CODE	MEANING
Loc	the keyboard is blocked
- - -	the operation requested is not available

Alarms

CODE	MEANING
rtc	Clock alarm Solutions: set date, time and day of the week

AL	Minimum temperature alarm in the compartment Solutions: - check the room temperature or CPT temperature; see A1 parameter Main consequences: - the alarm output will be switched on
AH	Maximum temperature alarm in the compartment Solutions: - check the room temperature or CPT temperature; see A4 parameter Main consequences: - the alarm output will be switched on
id	Door switch input alarm Solutions: - check the causes of the activation of the input; see i0 and i1 parameters Main consequences: - the effect established with the i0 parameter - the alarm output will be switched on
PF	Power failure alarm Solutions: - touch a key - check electrical connection
dFd	Defrost alarm switched off because maximum time has been reached Solutions: - check the integrity of the evaporator probe; see d2, d3 and d11 parameters - touch a key to restore normal display Main consequences: - the device will continue to operate normally

When the cause of the alarm disappears, the device restores normal operation, except for the following alarms:

- the compressor blocked alarm (code "CSd") and the global thermal protection alarm (code "th"), which both need to be reset by turning the device off or switching off the power supply.
- defrost alarm switched off because maximum time has been reached (code "dFd") which requires the touching of a key.

Errors

CODE	MEANING
Pr1	Room temperature probe or inlet air probe error Solutions: - check that the probe is the PTC or NTC type; see P0 parameter - check the device-probe connection - check room temperature/CPT temperature Main consequences: - compressor activity will depend on C4 and C5 parameters - if the P4 parameter is set at 3, the temperature associated with the regulation and the temperature alarms shall be the outgoing air temperature - the defrost will not be activated - the alarm output will be switched on - the door heating elements shall be turned off - the neutral area operation heating elements will be turned off
Pr2	Evaporator/defrost probe error Solutions: - the same as in the previous example, but with regard to the evaporator probe Main consequences: - if P3 parameter is set at 1, the defrost interval will last for the amount of time set with d3 parameter - if P3 parameter is set at 1 and d8 parameter is set at 2 or to 3, the device will operate as if d8 parameter were set at 0 - if P3 parameter is set at 1 or 2 and F0 parameter is set at 3 to 4, the device will operate as if parameter were set at 2 - the alarm output will be switched on

When the cause of the error disappears, the device restores normal operation.

РАЗМОРАЖИВАНИЕ

РАЗМОРАЖИВАНИЕ ХОЛОДИЛЬНЫХ ШКАФОВ ПОЛНОСТЬЮ АВТОМАТИЧЕСКОЕ.

Размораживание происходит при "НОРМАЛЬНАЯ ТЕМПЕРАТУРА 0/+10°C ÷ +2/10°C" воздухом и происходит автоматически каждые 6 часов. Размораживание длится 20 минут.

Размораживание установок при "НОРМАЛЬНАЯ ТЕМПЕРАТУРА -2/+10°C ÷ -2/+8°C" сопротивлением и происходит автоматически каждые 6 часов. Длительность размораживания саморегулируется холодильником.

Размораживание установок при “НИЗКАЯ ТЕМПЕРАТУРА -24/-12°C” на горячий газ и происходит автоматически каждые 6 часов работы компрессора. Длительность размораживания саморегулируется холодильником.

Возможно активировать в любой момент цикл размораживания, нажав на 5 секунд кнопку “^❄”; размораживание автоматически осуществится каждые 6 часов с этого момента для “НОРМАЛЬНАЯ ТЕМПЕРАТУРА” и каждые 6 часов работы компрессора для “НИЗКАЯ ТЕМПЕРАТУРА”.

ЗАГРУЗКА ПРОДУКТА

- Распределить продукт внутри камеры холодильника единообразным способом, чтобы позволить хорошую циркуляцию воздуха;
- Избегать заслонения зон вентиляции установки охлаждения, помещенного с левой части камеры;
- Избегать помещения продуктов, которые нуждаются в низких температурах сохранения в последний ящик внизу справа;
- Накрывать или заворачивать пищевые продукты до того, как помещать их внутрь приспособления в специальные предохранительные плёнки;
- Не помещать в аппарат пищу или напитки слишком горячие;
- Не оставлять дверцы открытыми на больше, чем требуется для взятие или помещения продуктов питания;
- Только загрузите верхнюю полку до отметки штабелирования;
- Не кладите продукты ниже нижней опоры полки.

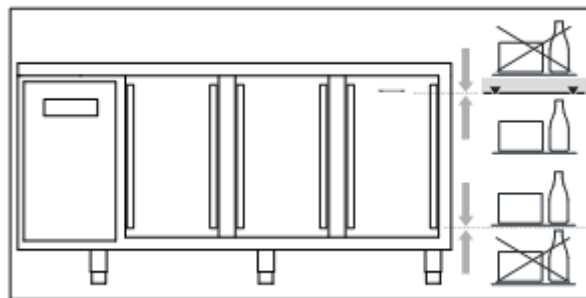

- *Модель Snack:* при загрузке нижние ящики не превышают предельной нагрузки.

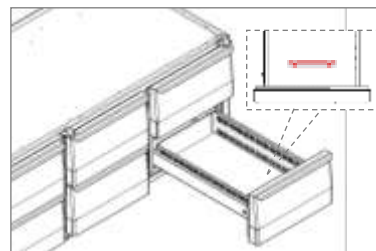

ОСТАНОВКА

В любых условиях для выключения аппаратуры достаточно установить кнопку генерального выключателя 1 в положение OFF.

ВНИМАНИЕ: кнопка генерального выключателя 1 НЕ изолирует аппарат от электричества.

Установить выключатель в позицию OFF.

Для изолирования холодильника от электричества вынуть из розетки штепсельную вилку.

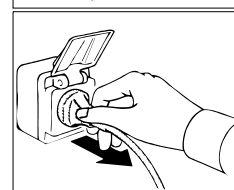
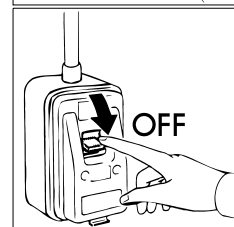
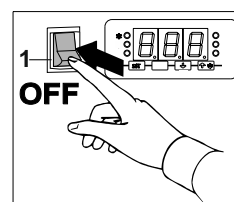

ВОЗМОЖНЫЕ ПОЛОМКИ ПРИ ЭКСПЛУАТАЦИИ

В случае поломки, до того как сообщать в техобслуживание, проконтролировать, что:

- генеральный выключатель(1) светиться и в сети есть электричество;
- показатель температуры выставлен на желаемую температуру;
- двери плотно закрыты;
- аппарат не находится вблизи тепла;
- конденсатор чистый и вентилятор работает регулярно;
- на испарительной пластине нет чрезмерного количества инея.

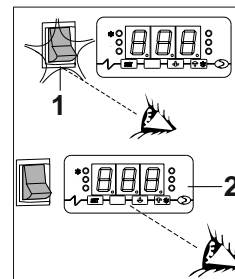

В случае, если эти проверки имели негативные показатели, обратиться в техобслуживание, указывая всю информацию о модели, номер и серию паспорта, находящихся на технической табличке, установленной на щитке аппарата.

ПЕРЕРЫВ В ИСПОЛЬЗОВАНИИ

В случае, когда холодильник был включен долгое время и для сохранения его в лучшем состоянии действуйте следующим образом:

- перевести генеральный выключатель в позицию OFF.
- выньте вилку из розетки.
- освободите холодильник и вымойте его как описано в параграфе “ЧИСТКА”.
- оставить двери холодильника приоткрытыми, для удаления неприятных запахов.

ПРОБЛЕМЫ ФУНКЦИОНИРОВАНИЯ

Часто трудности в эксплуатации, которые могут определены это случайные трудности и почти всегда разрешаются без вмешательства специализированного персонала. Поэтому перед вызовом техника проконтролируйте:

ПРОБЛЕМА	ВОЗМОЖНЫЕ ПРИЧИНЫ
Аппаратура не включается	Проконтролируйте, если вилка включена в сеть
Внутренняя температура очень высокая	Проконтролируйте, что ток подходит к розетке
Аппарат работает очень шумно	Проверить регулицию терморегулятора
Внутри холодильника неприятные запахи	Проверить, что вблизи нет источника тепла
	Проверить, что дверь плотно закрыта
Аппаратура не включается	Проверить невилирование аппаратуры.
Внутренняя температура очень высокая	Неуравновешанная позиция может быть причиной вибраций
	Проверьте, что аппаратура не находится в контакте с другой аппаратурой или частями, которые могли бы войти в резонанс
Аппарат работает очень шумно	Имеются продукты с сильным запахом (например сыр и дыня), которые находятся в незакрытых контейнерах
Внутри холодильника неприятные запахи	Внутренние поверхности должны быть чистыми
На аппарате формируется конденсация	Повышенная влажность помещения
	Плохо закрыты двери

Прodelайте все эти проверки, если проблема не устраняется, обатиться в техобслуживание, не забывая сообщить следующее:

- природа дефекта
- модель и номер паспорта аппарата, которые находятся на табличке электрических х характеристик, расположенной на щитке аппарата.

ТЕХНИЧЕСКАЯ СХЕМА РЕФРИЖЕРАТОРА

R290

GWP = 3

ODP = 0

❖ Идентификация опасности

Сжиженный газ - Чрезвычайно легко воспламеняющийся

❖ Меры первой помощи

• Вдыхание:

При высоких концентрациях может вызвать удушье. Симптомы могут включать потерю подвижности / сознания. Жертвы не осознают своего состояния. При низких концентрациях может вызвать наркотические эффекты. Симптомы могут включать головокружение, головную боль, тошноту и потерю координации. Вынести пострадавшего на не загрязненный участок и надеть дыхательный аппарат. Уложить пациента в теплое место. Вызвать врача. Сделать искусственное дыхание, если дыхание останавливается.

• Контакт с кожей и глазами:

В случае утечки тщательно промыть водой в течение не менее 15 минут

• При проглатывании:

Мало вероятный путь воздействия

❖ Воздействие на окружающую среду

Экологический ущерб, причиняемый этим продуктом, не известен.

ЭЛЕКТРИЧЕСКАЯ СХЕМА

Электрическая схема, расположена на последней странице книжки.

Поз.	Описание	Поз.	Описание
1	КОМПРЕССОР	20С	СОПРОТИВЛЕНИЕ АНТИКОНДЕНСАЦИИ ДВЕРЕЙ
2	ВЕНТИЛЯТОР КОНДЕНСАТОРА	21	СОПРОТИВЛЕНИЕ РАЗМОРАЖИВАНИЯ
3	КЛЕММНИК	22	СОПРОТИВЛЕНИЕ ДНА БАЧКА
6	ОБЩИЙ ВЫКЛЮЧАТЕЛЬ	44	РЕЛЕ МОЩНОСТИ
8	ЭЛЕКТРИЧЕСКАЯ ВИЛКА	69	КЛЕММА ЗАЗЕМЛЕНИЯ
9	ВЕНТИЛЯТОР ИСПАРИТЕЛЯ	75	ЭЛЕКТРОВЕНТИЛЬ
12	ЭЛЕКТРОКЛАПАН РАЗМОЖИВАНИЯ	88	ЦИФРОВОЙ ТЕРМОРЕГУЛЯТОР
20	СОПРОТИВЛЕНИЕ АНТИКОНДЕНСАЦИИ ДВЕРЕЙ	90	ЦИФРОВОЙ ТЕРМОРЕГУЛЯТОР
20А	СОПРОТИВЛЕНИЕ АНТИКОНДЕНСАЦИИ ДВЕРЕЙ	102	ТЕРМОСТАТ БЕЗОПАСНОСТИ
20В	СОПРОТИВЛЕНИЕ АНТИКОНДЕНСАЦИИ ДВЕРЕЙ		